

# KNX Catalogue



18



06

**KNX**

The worldwide uniform standard



22

**PUSH-BUTTON SENSORS**

Product families F 50 and F 40

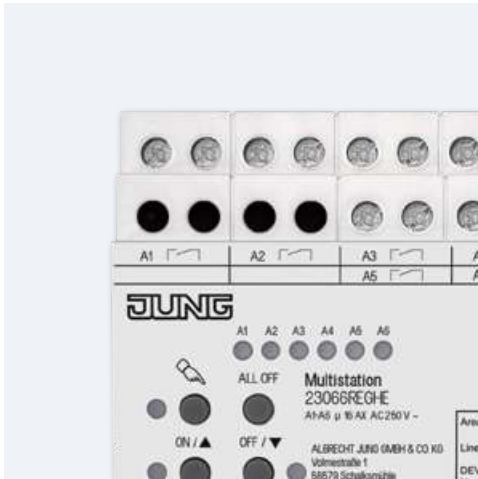

188

**MULTISTATION**

Compact device for the distribution



248

**SMART VISU SERVER**

Visualisation solution for the smart home

# Table of contents

## COMPANY

Progress as tradition	02
-----------------------	----

## INTRODUCTION

When is a building smart?	04
KNX as worldwide standard	06
Functions and applications	08
Reference projects	10

## TOPOLOGY

The JUNG KNX system	16
---------------------	----

## PUSH-BUTTON SENSORS/ ROOM CONTROLLER

Operate KNX in the JUNG design	18
Graphic Tool	20
F 50 family	22
F 40 family	50
Room controller	70
KNX RF	80

## ROTARY SENSORS/PUSH-BUTTON BCU

Rotary sensors	88
Push-button BCU	94

## ROOM AUTOMATION

Presence Detector Mini	116
Presence detector/ceiling observer	122
Automatic switch	126
Room thermostat	132

## SYSTEM DEVICES

System design	146
---------------	-----

## COMMUNICATION/GATEWAYS

DALI-Gateway	158
--------------	-----

## ACTUATORS / COMBINATION DEVICES

Actuators for rail mounting	162
Multistation	188
Flush mounting actuators	192

## BINARY INPUTS

Binary inputs	202
---------------	-----

## ENERGY SENSOR

Energy sensor	206
---------------	-----

## MULTIROOM/AUDIO

Multiroom amplifier	210
Sonos Gateway	216

## WEATHER STATIONS

Weather stations	220
------------------	-----

## SIGNALLING SYSTEM

Signalling System	230
-------------------	-----

## VISUALISATION/OPERATION

Signal panel	236
Smart Panel	238
Smart Controls	242
Smart Visu Server	248
JUNG Visu Pro	256
JUNG Visu Pro Server	260

## DOOR COMMUNICATION

Door communication and KNX	264
----------------------------	-----

Index	266
-------	-----

Sales terms and delivery conditions	271
-------------------------------------	-----

Further information	272
---------------------	-----



Ernst Paris

Company founder Albrecht Jung



# Progress as tradition. Every day.

When Albrecht Jung founded his company in 1912, three things were already important to him: progress, quality and design. These principles have characterised JUNG to date and are noticeable and can be experienced in all parts of the company.

“Progress as tradition” is an attitude, the commitment to constant new thinking. A commitment to the development of ideas that create something new, for easier use, better functionality, more attractive appearance and more customer-friendly service. This motivates and unites us at JUNG. Every day.

## WE ARE JUNG:

**1912**

Medium sized third generation family company



“Made in Germany” for more than 100 years.



Around 1,200 employees



17 subsidiaries and over 70 agencies worldwide

# When is a building smart?

When all its functions of modern building system technology are practically interlinked and communicate with each other. This means extra comfort, cost-effectiveness, safety and energy efficiency. Our solutions are based on the global KNX standard and are therefore absolutely future-proof. From the easy to use control element to the complex system, the JUNG KNX components provide comprehensive, future-proof solutions for control, visualisation and organisation of the building system technology. Areas such as lighting, shade, heating / air conditioning, surveillance / security, multimedia and smart metering are completely covered here.

From the basic configuration to the high-end comfort solution, everything is possible. The professional JUNG KNX technology can be adapted to new requirements at any time.



Function

Visualisation

Evaluation

System  
reliability





# KNX – the worldwide systematic standard

KNX is the only globally recognised standard for building system technology. The European standard EN 50090 has become established as global standard according to ISO / IEC 14543-3. The „KNX“ label makes clear the system compatibility of the products of all manufacturers.

## FACTS AND FIGURES

**1990** 28 years of experience



76.392 partners in  
164 countries



442 manufacturers in  
44 countries



444 training centres in  
68 countries

Date: May 2018





### **FUTURE-PROOF**

KNX as building system technology is consistently further developed. As international standard, KNX is future-oriented and guarantees constant upgradeability when new components appear, also manufacturer-independent.

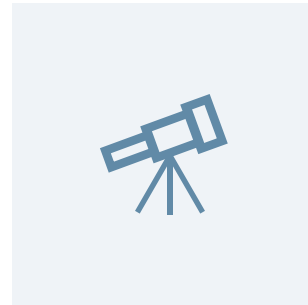

### **INVESTMENT SECURITY**

High quality, certified KNX products and the global standardisation guarantee a sustainable investment in a long-lasting system. The KNX system has existed for more than 25 years and first generation devices are still compatible with the latest KNX products.

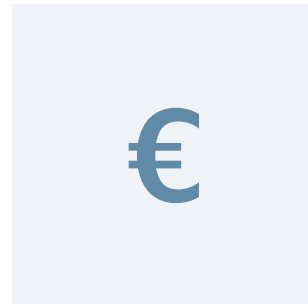

### **SYSTEM RELIABILITY**

Products with the KNX logo „speak and understand“ the KNX language. They are programmed and put into operation using the manufacturer-independent Engineering Tool (ETS™). Strict KNX interworking rules ensure that the certified products of different manufacturers can communicate with each other in various applications. KNX has standardised complete sets of data types for a large number of functions for this.

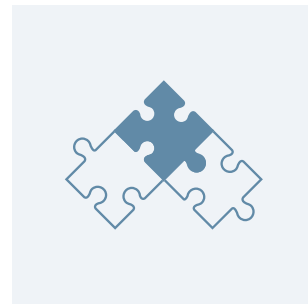

### **DECENTRALISED SYSTEM DESIGN**

KNX functions as a modular system. Network and building technology can thus be expanded and rebuilt in any way at any time. Customised and economic solutions can always be found for small or large projects, modernisation or new construction.

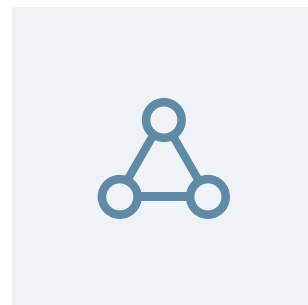



## Life in the smart home: Functions and applications

KNX is the future-proof solution for the professional smart home: the lighting scene in the living room matches the well-being temperature perfectly. It stays pleasantly cool in the bedroom because the shutters automatically descend during sunlight. The favourite music can be heard in every room thanks to multi-rooming. With intelligent technology from JUNG.





### LIGHTING

Individual control of the indoor and outdoor lighting. Automatically, as needed and thus energy saving.



### BLINDS AND SHUTTERS

The automatic control of blinds and shutters including louvre adjustment is regulated by sunlight. The control is performed centrally or decentralised.



### MONITORING/ALARMING

Sensors for monitoring windows and doors, central on/off controls and notification and alarm systems give a secure feeling.



### HEATING, VENTILATION, AIR CONDITIONING

Demand-based control of heating, ventilation and air conditioning ensure not only the individual well-being temperature but also a healthy room climate.



### MULTIMEDIA

Multi-rooming in the entire house, TV and entertainment systems and multimedia components are integrated in KNX.



### VISUALISATION AND REMOTE CONTROL

Display and operate all states in your own home using touch displays. Also when on the move from smart phones and tablets.

**House at Achalm, Reutlingen**

Architect: ALEXANDER BRENNER ARCHITEKTEN

Fitted with JUNG KNX technology  
in the LS 990 design.





# Cultivated objectivity



Smart building technology in prestigious architecture – combined in one high requirement: always only the best. Owners in the whole world have confidence in the intelligent KNX technology for their homes. Realised in the versatile JUNG design, pure aesthetics become cultivated objectivity.

# Smart and economical



Investment security is the main argument for the decision for building automation in office and administrative building construction. It should be economic, energy-efficient and functional. Also important: Flexibility in adaptation to changing renting situations. The good thing here is that owners and planners worldwide can rely here on the smart KNX solutions of JUNG.



**Dreischeibenhaus, Düsseldorf**

Architect: HPP Hentrich –  
Petschnigg & Partner  
Fitted with JUNG KNX technology  
in the LS 990 design.





**Park Hyatt Vienna, Austria**

Architect/planner FG stijl, Amsterdam, Netherlands

Photos: © Park Hyatt Vienna

Fitted with JUNG KNX technology  
in the LS 990 design.





# Intelligent comfort



Hotel operators worldwide have confidence in the advantages of intelligent KNX technology from JUNG. Whether well-known hotel chains such as the Hyatt Group with its Park Hyatt Vienna in Austria or first-class family and design hotels: with KNX, maximum comfort for the guest is combined with reliability and cost effectiveness for the operating company in a uniquely smart way.

# Systematically linked: the JUNG KNX system

## Central control

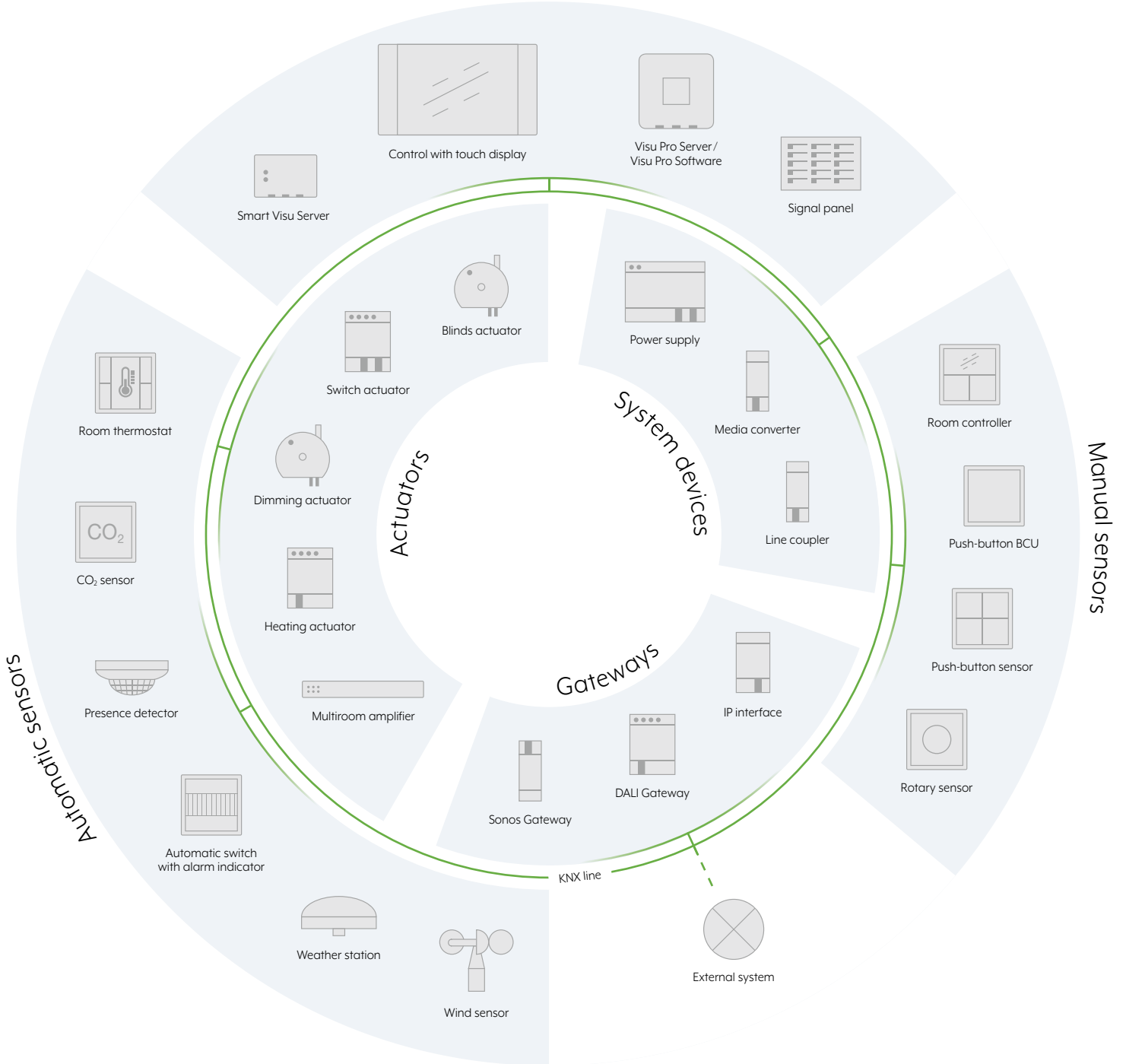

22

**MANUAL SENSORS**

The execution of the commands and implementation of the physical states for the manual sensors are performed manually by pressing buttons or rotary movements. The information is forwarded via the KNX bus to the implementing devices.



116

**AUTOMATIC SENSORS**

Presence detectors, weather stations or room thermostats, among other things, convert physically measured factors into electrical values, process these and send a telegram on the KNX bus for implementation of the relevant commands.



146

**SYSTEM DEVICES**

The different KNX system devices are needed for the establishment of the bus structure (line and area couplers), as interfaces for the programming and operation of the KNX installation.



158

**GATEWAYS**

The KNX gateways form an interface between KNX and an external network. Thereby, they translate the incoming and outgoing messages and transfer the data of the two different networks.



162

**ACTUATORS**

Actuators receive information from the sensors, execute commands and feed back current states to the display elements of the sensors. Appropriate actuators in different designs are available in the JUNG KNX system for every application.



236

**CENTRAL CONTROL**

The various KNX central control units form the node for networking and common control of all KNX functions, both room-related as well as for the entire building.

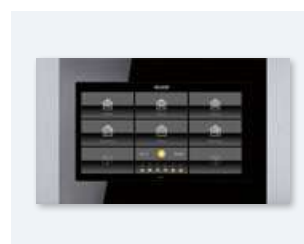

# Operate KNX in the JUNG design



**THE F 50 COMPACT ROOM CONTROLLER**

LS 990 in black/chrome



**PUSH-BUTTON SENSOR F 50**

Operating buttons on the left and right, large cover in the middle.

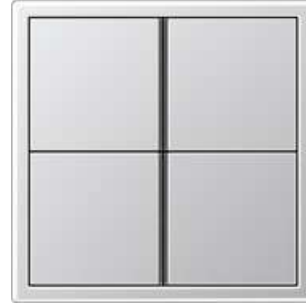
**PUSH-BUTTON SENSOR F 40**

Simply press: large buttons for control of the building technology.

**PUSH-BUTTON BCU**

Looks like a usual switch; however controls smart KNX functions.

**ROTARY SENSOR**

As for a conventional rotary dimmer: turn, press, initiate function.

When the design makes the operation self-explanatory: the KNX sensors in the JUNG design. High-quality materials and clear forms complement the concept with style.



**PUSH-BUTTON SENSOR F 40**  
LS 990 in stainless steel

# Clear labelling

JUNG components are labelled according to individual requirements using the Graphic Tool. Using laser engraving or colour printing process depending on material and colour. Whether manufactured for the entire building or for one piece. Inscription fields can also be printed independently above the labelling.

## LASER ENGRAVING

Precise erosion of the surface for a particularly valued appearance: the finest contours of symbols and texts must also be realised using laser engraving. A striking form of product refinement, particularly for the metal variants.

Labelling in the catalogue part: **L**



## COLOUR PRINTING

Easily integrate the design of the electrical installation in the own corporate design – using abrasion-resistant colour printing. Symbols, individual texts and patterns also give the elements an unmistakable look.

Labelling in the catalogue part: **P**



## LABELLING

Many Jung products have an integrated labelling field. These can be printed with text or symbols using the labelling. The functions of KNX sensors and more are clearly identified.

Graphic-Tool on-line: [jung.de/gt](http://jung.de/gt)





**PUSH-BUTTON SENSOR F 50**

LS 990 in aluminium/chrome

The F 50 sensors provide plenty of space on the concise information area for individual marking with the graphic tool. Operation is then via the buttons arranged at the side.

# The F 50 family

## PUSH-BUTTON SENSORS

For the control of functions and scenes. The scope of delivery includes the transparent design with a large labelling area as standard; this can optionally be replaced with a coloured version.



## PUSH-BUTTON SENSORS RF

KNX RF is the manufacturer-independent KNX wireless standard. These push-button sensors have the same operating concept and design as the well-known push-button sensors with twisted pair connection.



## COMPACT ROOM CONTROLLER

Impressive thanks to an intuitive operating concept and two integrated temperature controllers. The backlit LC display clearly legibly shows the most important values and functions.



## ROOM TEMPERATURE CONTROLLER

Device for individual room temperature control. The preference can be changed to the push-button sensor functions of switching, dimming, blinds, transducers, or scenes.

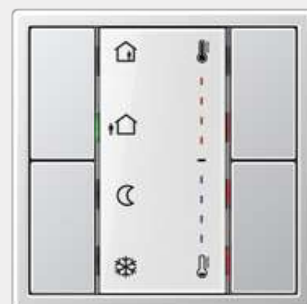







**PUSH-BUTTON SENSOR F 50**  
LS ZERO in aluminium

# Individual button assignment

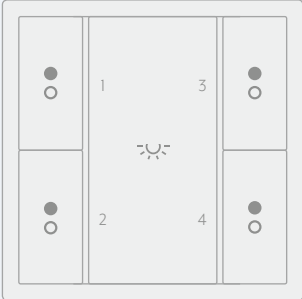
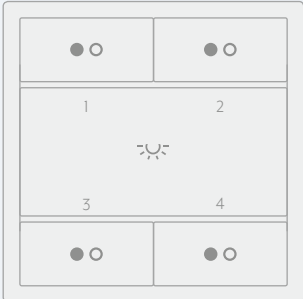
<p><b>TWO BUTTONS OPERATION</b></p>  <p>Two functions (operation left/right)</p>	<p><b>TWO BUTTONS OPERATION</b></p>  <p>Two functions (operation up/down)</p>
<p><b>ONE BUTTON OPERATION</b></p>  <p>Four functions (toggle)</p>	<p><b>ONE BUTTON OPERATION</b></p>  <p>Possible in one or two button operation</p>

For the Standard and Universal F 50 push-button sensors two operating modes can always be set: one button operation and two buttons operation. In the case of the two buttons variant, the operation can be optionally programmed for up/down or left/right. Horizontal mounting with appropriate button assignment can also be realised.



**THE F 50 COMPACT ROOM CONTROLLER**

A creation in black with glass frame

## Illuminating: the RGB LEDs

Universal F 50 push-button sensors have one operation LED and a status LED per button. These can be freely set in red, green and blue. The LEDs and the illuminated labelling area can each be adjusted for brightness so that, for example, one LED can be used as pilot light.



# Versatile functionality

## INSCRIPTION AREAS

The inscription areas exist as transparent version and as coloured variant – that is unique in the market.



## OPTIMISED: THE INSTALLATION

Flat design and low installation depth make the push-button sensors easy to mount. The easily accessible terminals for the KNX bus and the push-button extension module are clearly labelled:

- 1 Extension module
- 2 KNX bus



## PRACTICAL: THE CONSTRUCTION SITE COVERAGE

Thanks to the construction site coverage, button and function assignment can already be realised in construction site operation. The decision for button and cover design thus has time until the project acceptance.



## INTEGRATED: THE TEMPERATURE SENSOR\*

The temperature at various places in the room can be measured with the temperature sensor. The values are transmitted to the room temperature controller or room controller for effective control.



## ILLUMINATING: THE LIGHT SCENE MEMORY\*

Up to eight light scenes can be stored in the integrated light scene memory; in turn, eight groups can be assigned to each scene. These scenes can be called up using buttons or other KNX commands.



\*only for Universal version

# Efficient and flexible: push-button extension module F 50

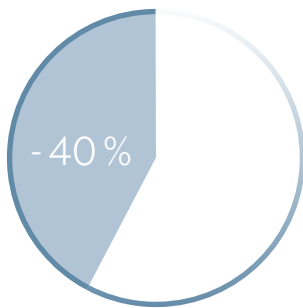

## COST SAVING

In comparison with exclusive use of push-button sensors in the KNX installation shown, the saving is 40%.

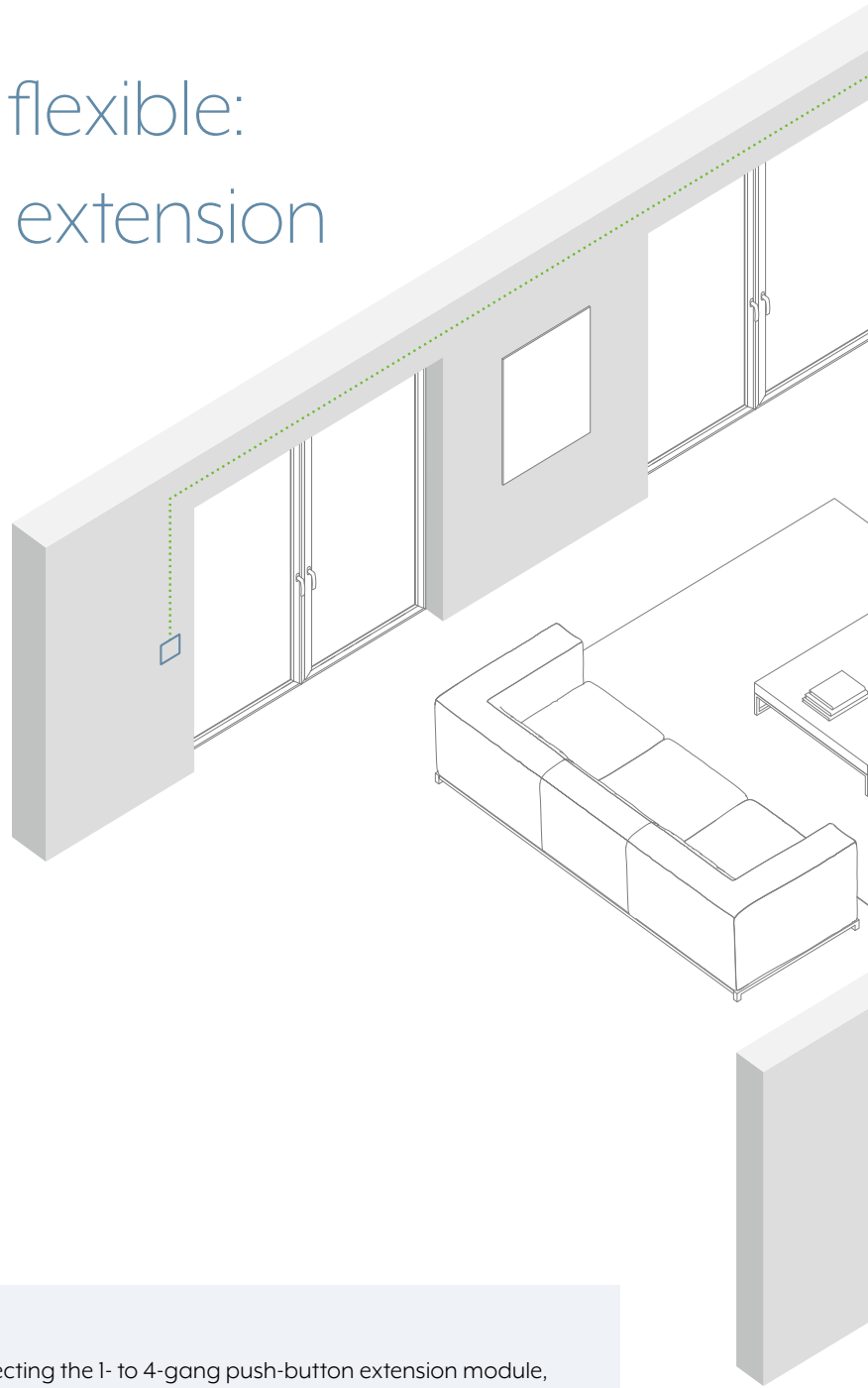

## PUSH-BUTTON EXTENSION MODULE

The functions can be extended by connecting the 1- to 4-gang push-button extension module, while at the same time minimising the load on the bus. Particularly the option for installation of the extension module at a distance of up to 30 m provides more flexibility.







- KNX line
- Basic module
- Extension module

## Variety of designs

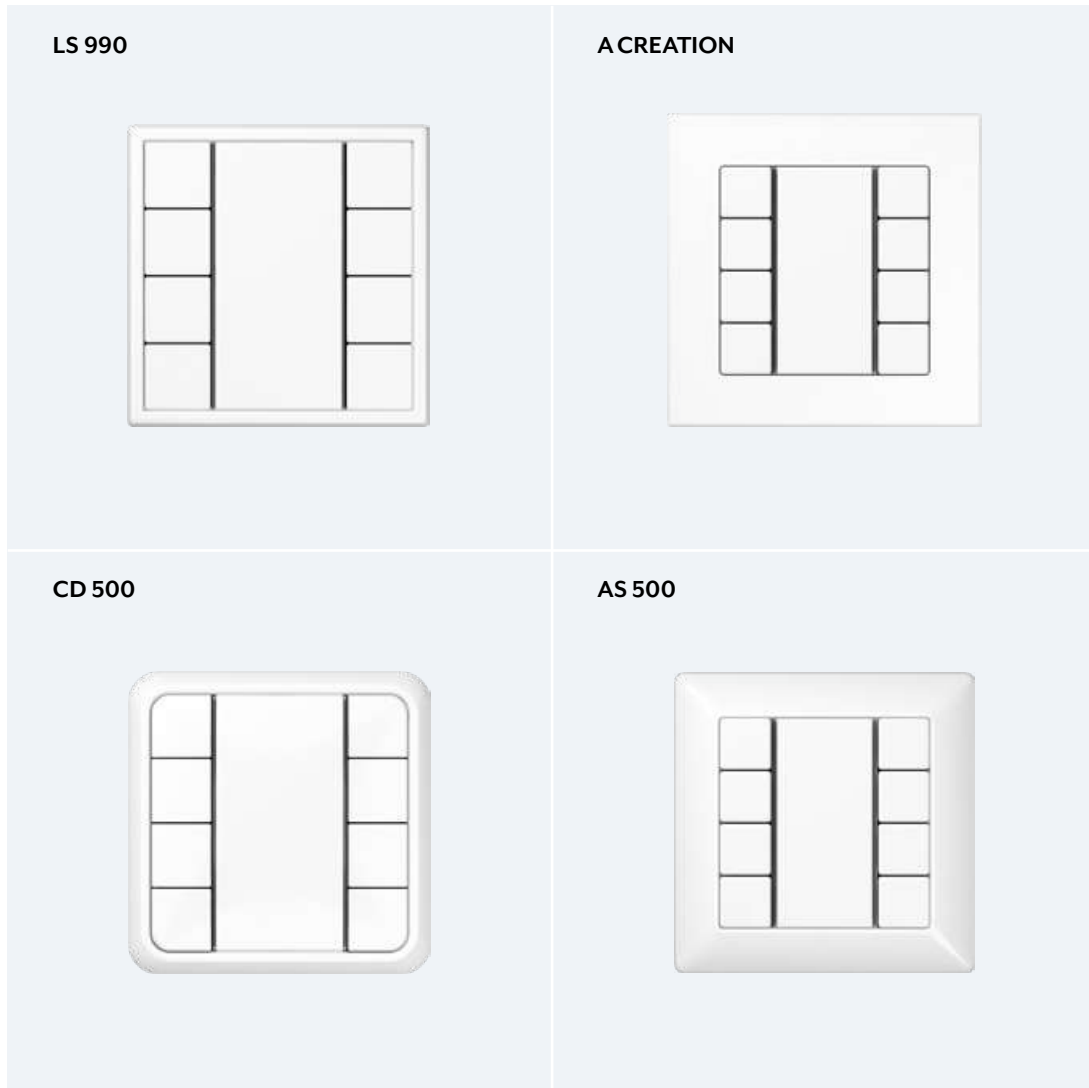

High quality materials, distinctive forms and a wide variety of colours determine the JUNG design. The AS, A, CD and LS ranges give the KNX sensors their attractive appearance. They can be selected to match the ambiance for each room.



# Modular system

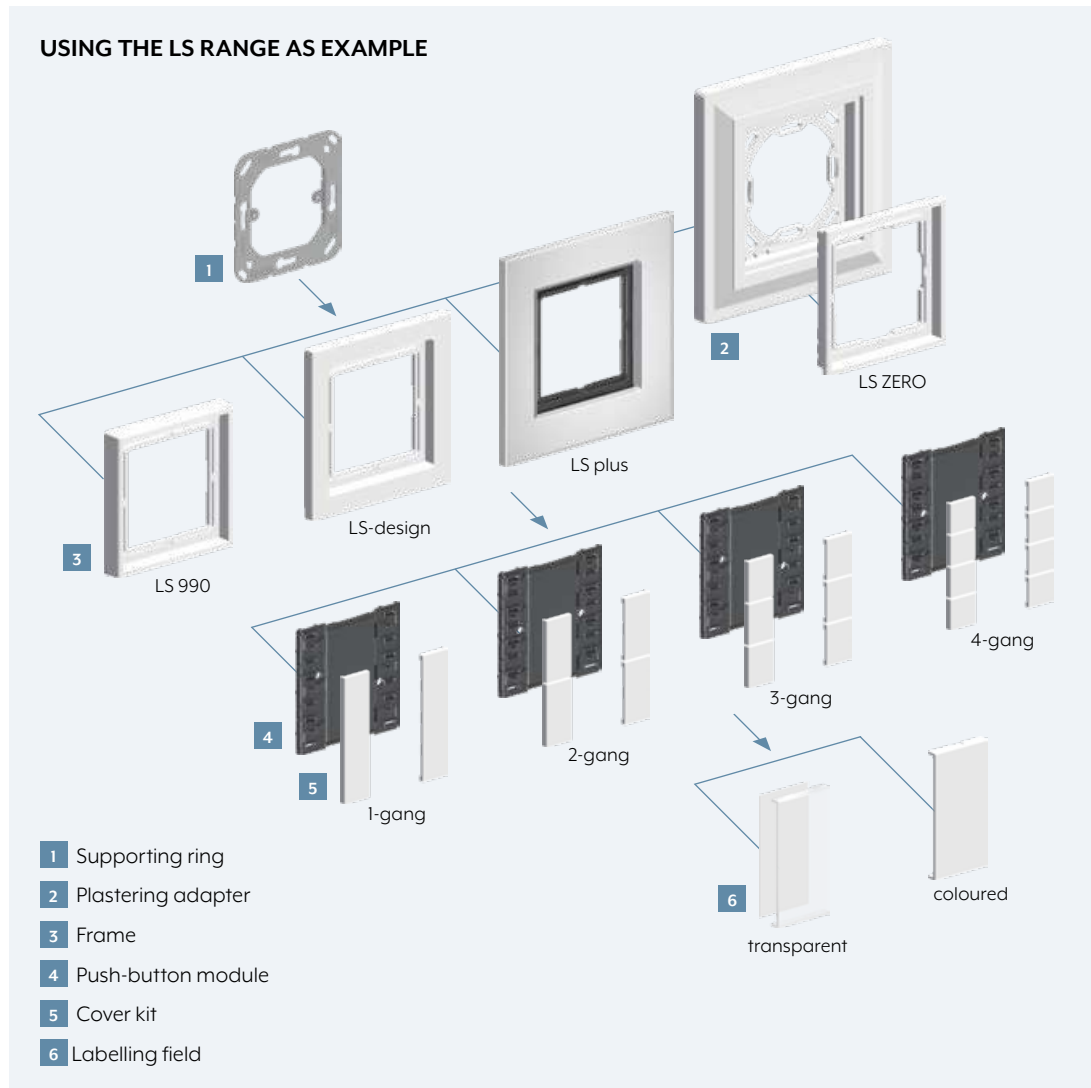

The 1, 2, 3 and 4-gang F 50 modules are available in the JUNG design; also the corresponding 1 to 4-gang Cover kits. The transparent or coloured labelling field is optionally added to this. The design frames of the various ranges round off the concept.



Ref.-no.

**Standard push-button module**

including transparent cover ref.-no.: A 50 NA

**Intended use**

- Operation of loads, e.g. light on/off, dimming, blinds up/down, calling up and saving light scenes, etc.
- Installation in flush-box according to DIN 49073

**Product characteristics**

- Push-button functions for switching, dimming, blinds control, valuator, light scenes, etc.
- To be completed with cover kit
- Inscription field
- One red status LED for a pair of buttons
- One operation LED as orientation light and programming status – red, green or blue, adjustable
- Energy saving mode
- Integrated bus coupling unit
- Transparent cover kit (included) for temporary site use without design covers

**Standard push-button module, 1-gang**

for cover kit 1-gang, complete, ref.-no.: A 501 TSA ..

ETS product family: Push-button

Product type: 1-gang push-button

**A 5071 TSM****Standard push-button module, 2-gang**

for cover kit 2-gang, complete, ref.-no.: A 502 TSA ..

ETS product family: Push-button

Product type: 2-gang push-button

**A 5072 TSM****Standard push-button module, 3-gang**

for cover kit 3-gang, complete, ref.-no.: A 503 TSA ..

ETS product family: Push-button

Product type: 3-gang push-button

**A 5073 TSM****Standard push-button module, 4-gang**

for cover kit 4-gang, complete, ref.-no.: A 504 TSA ..

ETS product family: Push-button

Product type: 4-gang push-button

**A 5074 TSM**

Ref.-no.

## Universal push-button module

including transparent cover ref.-no.: A 50 NA

### Intended use

- Operation of loads, e.g. light on/off, dimming, blinds up/down, brightness values, temperatures, calling up and saving light scenes, etc.
- Installation in flush-box according to DIN 49073

### Product characteristics

- Push-button functions for switching, dimming, blinds control, valuator, light scenes, etc.
- One or two functions per button
- To be completed with cover kit
- Inscription field can be illuminated
- One status LED per button, red, green or blue, adjustable
- One operation LED as orientation light and programming status – red, green or blue, adjustable
- Brightness of status LED, operation LED and inscription field adjustable, can be changed during operation, e.g. during night times
- Measurement of room temperature
- Extension unit for room temperature controller
- Disabling function: Disabling or change function mode of single or all button functions
- Alarm function, optional acknowledge by pressing any button
- Energy saving mode
- Integrated bus coupling unit
- Connection for a push-button extension module, 1-4 gang
- Transparent cover kit (included) for temporary site use without design covers

## Universal push-button module, 1-gang

for cover kit 1-gang, complete, ref.-no.: A 501 TSA ..

can be extended by means of a push-button extension module, ref.-no.: A 509.. TSEM

ETS product family: Push-button

Product type: 1-gang push-button

**A 5091 TSM**

## Universal push-button module, 2-gang

for cover kit 2-gang, complete, ref.-no.: A 502 TSA ..

can be extended by means of a push-button extension module, ref.-no.: A 509.. TSEM

ETS product family: Push-button

Product type: 2-gang push-button

**A 5092 TSM**

## Universal push-button module, 3-gang

for cover kit 3-gang, complete, ref.-no.: A 503 TSA ..

can be extended by means of a push-button extension module, ref.-no.: A 509.. TSEM

ETS product family: Push-button

Product type: 3-gang push-button

**A 5093 TSM**

## Universal push-button module, 4-gang

for cover kit 4-gang, complete, ref.-no.: A 504 TSA ..

can be extended by means of a push-button extension module, ref.-no.: A 509.. TSEM

ETS product family: Push-button

Product type: 4-gang push-button

**A 5094 TSM**







Ref.-no.

**Room temperature controller module 2-gang**

including transparent cover and inlay with symbols  
for cover kit 2-gang, complete, ref.-no.: A 502 TSA ..

**A 5178 TSM****Intended use**

- Single-room temperature control in KNX installations
- Operation of loads, e.g. light on/off, dimming, blinds up/down, recalling and saving light scenes, etc.
- Installation in wall box according to DIN 49073

**Product characteristics**

All buttons can be assigned with push-button sensor functions or functions for controller operation.

- Measurement of the room temperature
- Room temperature control with setpoint value specification
- Extension for room temperature controller
- Push-button functions switching, dimming, blind control, value transmitter, scene recall, etc.
- One or two functions per button
- Completion with cover kit 2-gang
- Illuminable inscription field
- Two red status LEDs per button – red, green or blue adjustable
- One operation LED as an orientation light and to indicate the programming status – red, green or blue adjustable
- Brightness of status LED, operation LED and labelling field adjustable; switchable while in operation, e.g. during the night
- Disabling function: Disable or function switch-over of all or of individual push-button functions
- Alarm function, optionally with confirmation by pressing any button
- Energy saving mode (for operation without controller function)
- Integrated bus coupling unit
- Connection for a push-button extension module, for extension with up to eight additional buttons

**Push-button extension module**

including transparent cover ref.-no.: A 50 NA  
for the extension of the Universal push-button module (ref.-no.: A 509.. TSM) and  
room temperature controller module (ref.-no.: A 5178 TSM) with up to 4 additional push-buttons

1-gang	<b>A 5091 TSEM</b>
2-gang	<b>A 5092 TSEM</b>
3-gang	<b>A 5093 TSEM</b>
4-gang	<b>A 5094 TSEM</b>

**Product characteristics**

- One or two functions per button
- To be completed with cover kit
- Inscription field can be illuminated
- One status LED per button, red, green or blue, adjustable
- One operation LED as orientation light and programming status – red, green or blue, adjustable
- Brightness of status LED, operation LED and inscription field adjustable, can be changed during operation, e.g. during night times
- Measurement of room temperature
- Extension unit for room temperature controller
- Disabling function: Disabling or change function mode of single or all button functions
- Alarm function, optional acknowledge by pressing any button
- Energy saving mode
- Transparent cover kit (included) for temporary site use without design covers
- Cable lengths: max. 30 m, cable type: J-Y(St)Y 2 x 2 x 0.8 mm<sup>2</sup>

Ref.-no.

### Room controller display compact module 2-gang

for cover kit 2-gang, complete, ref.-no.: A 502 TSA ..  
 can be extended by means of a room controller extension module, ref.-no.: A 5178 TSEM  
 can be extended by means of a push-button extension module, ref.-no.: A 509.. TSEM

**A 5192 KRM TS D**

recommended mounting height: 1.5 m

### Room controller display compact module 4-gang

for cover kit 4-gang, complete, ref.-no.: A 504 TSA ..  
 can be extended by means of a room controller extension module, ref.-no.: A 5178 TSEM  
 can be extended by means of a push-button extension module, ref.-no.: A 509.. TSEM

**A 5194 KRM TS D**

recommended mounting height: 1.5 m

#### Intended use

- Measurement and feedback control of the room temperature
- Operation of loads, e.g. light on/off, dimming, blinds up/down, brightness values, temperatures, calling up and saving light scenes, etc.
- Installation in wall box according to DIN 49073

#### Product characteristics

Each button can be used for push-button sensor of controller functions.

- Backlit LC display
- One or two functions per button
- To be completed with cover kit
- Eight status LED – red, green or blue
- Brightness of status LED and LCD adjustable
- Integrated bus coupling unit
- Connection of extension modules
- Integrated room temperature sensor
- External sensor (ref.-no.: FF 7.8) can be connected
- Room temperature control with setpoint value specification
- Two internal independent controllers for two independent areas – in connection with extension modules
- Display of room or set temperature (°C or °F)
- Display of outdoor temperature – with external sensor, e.g. weather station
- Display of time, in conjunction with KNX time encoder
- Push-button function or rocker function
- Inhibit function: blocking or change of function of the entire or single button functions
- Alarm function, optional with acknowledge by pressing any button

### Room controller extension module 2-gang

for cover kit 2-gang, complete, ref.-no.: A 502 TSA ..  
 for the extension of a room controller module (ref.-no.: A 5192 KRM TS D, A 5194 KRM TS D) with a second room temperature control unit

**A 5178 TSEM**

#### Intended use

- Operation of loads, e.g. light on/off, dimming, blinds up/down, brightness values, temperatures, calling up and saving light scenes, etc.
- Measurement of room temperature
- Extension for room controller modules (.. 5192 KRM TS D, .. 5194 KRM TS D)
- Installation in wall box according to DIN 49073
- Cable lengths: max. 30 m, cable type: J-Y(St)Y 2 x 2 x 0.8 mm<sup>2</sup>



## Delivery of cover kits:

1 complete set per ref.-no.!

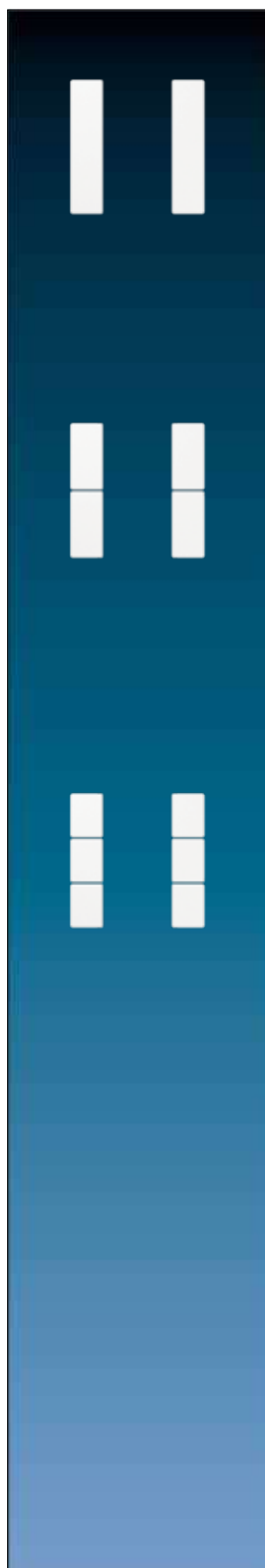

Ref.-no.

**Cover kit 1-gang**

to clip on F 50 push-button modules 1-gang of the AS/A range

ref.-no.: A 5071 TSM, A 5091 TSM, A 5091 TSEM, A 5071 RF TSM, A 5212 TSM, FM A 5001 M

**Thermoplastic (breakproof) high-gloss**

ivory		A 501 TSA
white		A 501 TSA WW
black		A 501 TSA SW

**Thermoplastic (breakproof) lacquered**

aluminium			A 501 TSA AL
champagne			A 501 TSA CH
mocha			A 501 TSA MO
matt anthracite			A 501 TSA ANM

**Cover kit 2-gang**

to clip on F 50 push-button modules 2-gang of the AS/A range

ref.-no.: A 5072 TSM, A 5092 TSM, A 5092 TSEM, A 5178 TSM, A 5192 KRM TS D, A 5178 TSEM, A 5072 RF TSM, A 5224 TSM, FM A 5002 M

**Thermoplastic (breakproof) high-gloss**

ivory		A 502 TSA
white		A 502 TSA WW
black		A 502 TSA SW

**Thermoplastic (breakproof) lacquered**

aluminium			A 502 TSA AL
champagne			A 502 TSA CH
mocha			A 502 TSA MO
matt anthracite			A 502 TSA ANM

**Cover kit 3-gang**

to clip on F 50 push-button modules 3-gang of the AS/A range

ref.-no.: A 5073 TSM, A 5093 TSM, A 5093 TSEM, A 5073 RF TSM, A 5236 TSM, FM A 5003 M, SI TM A 5073, SI TM A 5093

**Thermoplastic (breakproof) high-gloss**

ivory		A 503 TSA
white		A 503 TSA WW
black		A 503 TSA SW

**Thermoplastic (breakproof) lacquered**

aluminium			A 503 TSA AL
champagne			A 503 TSA CH
mocha			A 503 TSA MO
matt anthracite			A 503 TSA ANM



**P** Colour printing possible

**L** Laser labelling possible

Ref.-no.

### Cover kit 4-gang

to clip on F 50 push-button modules 4-gang of the AS/A range

ref.-no.: A 5074 TSM, A 5094 TSM, A 5094 TSEM, A 5194 KRM TS D, A 5074 RF TSM, A 5248 TSM, FM A 5004 M, ZLL A 5004 M

#### Thermoplastic (breakproof) high-gloss

ivory	<b>L</b>	<b>A 504 TSA</b>
white	<b>L</b>	<b>A 504 TSA WW</b>
black	<b>L</b>	<b>A 504 TSA SW</b>

#### Thermoplastic (breakproof) lacquered

aluminium	<b>P</b>	<b>L</b>	<b>A 504 TSA AL</b>
champagne	<b>P</b>		<b>A 504 TSA CH</b>
mocha			<b>A 504 TSA MO</b>
matt anthracite	<b>L</b>		<b>A 504 TSA ANM</b>

### Transparent cover with paper inlay

(Spare part)

to clip on F 50 push-button modules of the AS/A range

ref.-no.: A 507.. TSM, A 509.. TSM, A 509.. TSEM, A 5178 TSM, A 51.. KRM TS D, A 5178 TSEM, A 507.. RF TSM, A 52.. TSM, FM A 50.. M, ZLL A 5004 M

Also included in delivery of modules.

inscription field 25 x 52.5 mm

paper inlay pearly		<b>A 50 NA</b>
--------------------	--	----------------

### Neutral cover

to clip on F 50 push-button modules of the AS/A range

ref.-no.: A 507.. TSM, A 509.. TSM, A 509.. TSEM, A 5178 TSM, A 51.. KRM TS D, A 5178 TSEM, A 507.. RF TSM, A 52.. TSM, FM A 50.. M, ZLL A 5004 M

dimensions: 25 x 55 mm

#### Thermoplastic (breakproof) high-gloss

ivory	<b>L</b>	<b>A 50 NA W</b>
white	<b>L</b>	<b>A 50 NA WW</b>
black	<b>L</b>	<b>A 50 NA SW</b>

#### Thermoplastic (breakproof) lacquered

aluminium	<b>P</b>	<b>L</b>	<b>A 50 NA AL</b>
champagne	<b>P</b>		<b>A 50 NA CH</b>
mocha			<b>A 50 NA MO</b>
matt anthracite	<b>L</b>		<b>A 50 NA ANM</b>

Professional inscription see [www.jung.de/gt](http://www.jung.de/gt)



Ref.-no.

**Standard push-button module**

including transparent cover ref.-no.: CD 50 NA

**Intended use**

- Operation of loads, e.g. light on/off, dimming, blinds up/down, calling up and saving light scenes, etc.
- Installation in flush-box according to DIN 49073

**Product characteristics**

- Push-button functions for switching, dimming, blinds control, valuator, light scenes, etc.
- To be completed with cover kit
- Inscription field
- One red status LED for a pair of buttons
- One operation LED as orientation light and programming status – red, green or blue, adjustable
- Energy saving mode
- Integrated bus coupling unit
- Transparent cover kit (included) for temporary site use without design covers

**Standard push-button module, 1-gang**

for cover kit 1-gang, complete, ref.-no.: CD 501 TSA ..

ETS product family: Push-button

Product type: 1-gang push-button

**CD 5071 TSM****Standard push-button module, 2-gang**

for cover kit 2-gang, complete, ref.-no.: CD 502 TSA ..

ETS product family: Push-button

Product type: 2-gang push-button

**CD 5072 TSM****Standard push-button module, 3-gang**

for cover kit 3-gang, complete, ref.-no.: CD 503 TSA ..

ETS product family: Push-button

Product type: 3-gang push-button

**CD 5073 TSM****Standard push-button module, 4-gang**

for cover kit 4-gang, complete, ref.-no.: CD 504 TSA ..

ETS product family: Push-button

Product type: 4-gang push-button

**CD 5074 TSM**

Ref.-no.

### Universal push-button module

including transparent cover ref.-no.: CD 50 NA

#### Intended use

- Operation of loads, e.g. light on/off, dimming, blinds up/down, brightness values, temperatures, calling up and saving light scenes, etc.
- Installation in flush-box according to DIN 49073

#### Product characteristics

- Push-button functions for switching, dimming, blinds control, valuator, light scenes, etc.
- One or two functions per button
- To be completed with cover kit
- Inscription field can be illuminated
- One status LED per button, red, green or blue, adjustable
- One operation LED as orientation light and programming status – red, green or blue, adjustable
- Brightness of status LED, operation LED and inscription field adjustable, can be changed during operation, e.g. during night times
- Measurement of room temperature
- Extension unit for room temperature controller
- Disabling function: Disabling or change function mode of single or all button functions
- Alarm function, optional acknowledge by pressing any button
- Energy saving mode
- Integrated bus coupling unit
- Connection for a push-button extension module, 1-4 gang
- Transparent cover kit (included) for temporary site use without design covers

### Universal push-button module, 1-gang

for cover kit 1-gang, complete, ref.-no.: CD 501 TSA ..

can be extended by means of a push-button extension module, ref.-no.: CD 509.. TSEM

ETS product family: Push-button

Product type: 1-gang push-button

**CD 5091 TSM**

### Universal push-button module, 2-gang

for cover kit 2-gang, complete, ref.-no.: CD 502 TSA ..

can be extended by means of a push-button extension module, ref.-no.: CD 509.. TSEM

ETS product family: Push-button

Product type: 2-gang push-button

**CD 5092 TSM**

### Universal push-button module, 3-gang

for cover kit 3-gang, complete, ref.-no.: CD 503 TSA ..

can be extended by means of a push-button extension module, ref.-no.: CD 509.. TSEM

ETS product family: Push-button

Product type: 3-gang push-button

**CD 5093 TSM**

### Universal push-button module, 4-gang

for cover kit 4-gang, complete, ref.-no.: CD 504 TSA ..

can be extended by means of a push-button extension module, ref.-no.: CD 509.. TSEM

ETS product family: Push-button

Product type: 4-gang push-button

**CD 5094 TSM**







Ref.-no.

**Room temperature controller module 2-gang**

including transparent cover and inlay with symbols  
for cover kit 2-gang, complete, ref.-no.: CD 502 TSA ..

**CD 5178 TSM****Intended use**

- Single-room temperature control in KNX installations
- Operation of loads, e.g. light on/off, dimming, blinds up/down, recalling and saving light scenes, etc.
- Installation in wall box according to DIN 49073

**Product characteristics**

All buttons can be assigned with push-button sensor functions or functions for controller operation.

- Measurement of the room temperature
- Room temperature control with setpoint value specification
- Extension for room temperature controller
- Push-button functions switching, dimming, blind control, value transmitter, scene recall, etc.
- One or two functions per button
- Completion with cover kit 2-gang
- Illuminable inscription field
- Two red status LEDs per button – red, green or blue adjustable
- One operation LED as an orientation light and to indicate the programming status – red, green or blue adjustable
- Brightness of status LED, operation LED and labelling field adjustable; switchable while in operation, e.g. during the night
- Disabling function: Disable or function switch-over of all or of individual push-button functions
- Alarm function, optionally with confirmation by pressing any button
- Energy saving mode (for operation without controller function)
- Integrated bus coupling unit
- Connection for a push-button extension module, for extension with up to eight additional buttons

**Push-button extension module**

including transparent cover ref.-no.: CD 50 NA

for the extension of the Universal push-button module (ref.-no.: CD 509.. TSM) and  
room temperature controller module (ref.-no.: CD 5178 TSM) with up to 4 additional push-buttons

1-gang	<b>CD 5091 TSEM</b>
2-gang	<b>CD 5092 TSEM</b>
3-gang	<b>CD 5093 TSEM</b>
4-gang	<b>CD 5094 TSEM</b>

**Product characteristics**

- One or two functions per button
- To be completed with cover kit
- Inscription field can be illuminated
- One status LED per button, red, green or blue, adjustable
- One operation LED as orientation light and programming status – red, green or blue, adjustable
- Brightness of status LED, operation LED and inscription field adjustable, can be changed during operation, e.g. during night times
- Measurement of room temperature
- Extension unit for room temperature controller
- Disabling function: Disabling or change function mode of single or all button functions
- Alarm function, optional acknowledge by pressing any button
- Energy saving mode
- Transparent cover kit (included) for temporary site use without design covers
- Cable lengths: max. 30 m, cable type: J-Y(St)Y 2 x 2 x 0.8 mm<sup>2</sup>

Ref.-no.

### Room controller display compact module 2-gang

for cover kit 2-gang, complete, ref.-no.: CD 502 TSA ..

can be extended by means of a room controller

extension module, ref.-no.: CD 5178 TSEM

can be extended by means of a push-button extension module, ref.-no.: CD 509.. TSEM

**CD 5192 KRM TS D**

recommended mounting height: 1.5 m

### Room controller display compact module 4-gang

for cover kit 4-gang, complete, ref.-no.: CD 504 TSA ..

can be extended by means of a room controller

extension module, ref.-no.: CD 5178 TSEM

can be extended by means of a push-button extension module, ref.-no.: CD 509.. TSEM

**CD 5194 KRM TS D**

recommended mounting height: 1.5 m

#### Intended use

- Measurement and feedback control of the room temperature
- Operation of loads, e.g. light on/off, dimming, blinds up/down, brightness values, temperatures, calling up and saving light scenes, etc.
- Installation in wall box according to DIN 49073

#### Product characteristics

Each button can be used for push-button sensor of controller functions.

- Backlit LC display
- One or two functions per button
- To be completed with cover kit
- Eight status LED – red, green or blue
- Brightness of status LED and LCD adjustable
- Integrated bus coupling unit
- Connection of extension modules
- Integrated room temperature sensor
- External sensor (ref.-no.: FF 7.8) can be connected
- Room temperature control with setpoint value specification
- Two internal independent controllers for two independent areas – in connection with extension modules
- Display of room or set temperature (°C or °F)
- Display of outdoor temperature – with external sensor, e.g. weather station
- Display of time, in conjunction with KNX time encoder
- Push-button function or rocker function
- Inhibit function: blocking or change of function of the entire or single button functions
- Alarm function, optional with acknowledge by pressing any button
- Function symbols can be shown

### Room controller extension module 2-gang

for cover kit 2-gang, complete, ref.-no.: CD 502 TSA ..

for the extension of a room controller module (ref.-no.: CD 5192 KRM TS D, CD 5194 KRM TS D)

with a second room temperature control unit

**CD 5178 TSEM**

#### Intended use

- Operation of loads, e.g. light on/off, dimming, blinds up/down, brightness values, temperatures, calling up and saving light scenes, etc.
- Measurement of room temperature
- Extension for room controller modules (. 5192 KRM TS D, .. 5194 KRM TS D)
- Installation in wall box according to DIN 49073
- Cable lengths: max. 30 m, cable type: J-Y(St)Y 2 x 2 x 0.8 mm<sup>2</sup>



 Colour printing possible

 Laser labelling possible







Ref.-no.

#### Cover kit 1-gang

to clip on F 50 push-button modules 1-gang of the CD range

ref.-no.: CD 5071 TSM, CD 5091 TSM, CD 5091 TSEM, CD 5071 RF TSM, CD 5212 TSM, FM CD 5001 M

##### Thermoplastic (breakproof) high-gloss





ivory	 <b>CD 501 TSA</b>
white	 <b>CD 501 TSA WW</b>
grey	 <b>CD 501 TSA GR</b>
light grey	 <b>CD 501 TSA LG</b>
black	 <b>CD 501 TSA SW</b>

#### Cover kit 2-gang

to clip on F 50 push-button modules 2-gang of the CD range

ref.-no.: CD 5072 TSM, CD 5092 TSM, CD 5092 TSEM, CD 5178 TSM, CD 5192 KRM TS D, CD 5178 TSEM, CD 5072 RF TSM, CD 5224 TSM, FM CD 5002 M

##### Thermoplastic (breakproof) high-gloss





ivory	 <b>CD 502 TSA</b>
white	 <b>CD 502 TSA WW</b>
grey	 <b>CD 502 TSA GR</b>
light grey	 <b>CD 502 TSA LG</b>
black	 <b>CD 502 TSA SW</b>

#### Cover kit 3-gang

to clip on F 50 push-button modules 3-gang of the CD range

ref.-no.: CD 5073 TSM, CD 5093 TSM, CD 5093 TSEM, CD 5073 RF TSM, CD 5236 TSM, FM CD 5003 M, SI TM CD 5073, SI TM CD 5093

##### Thermoplastic (breakproof) high-gloss





ivory	 <b>CD 503 TSA</b>
white	 <b>CD 503 TSA WW</b>
grey	 <b>CD 503 TSA GR</b>
light grey	 <b>CD 503 TSA LG</b>
black	 <b>CD 503 TSA SW</b>

#### Cover kit 4-gang





to clip on F 50 push-button modules 4-gang of the CD range

ref.-no.: CD 5074 TSM, CD 5094 TSM, CD 5094 TSEM, CD 5194 KRM TS D, CD 5074 RF TSM, CD 5248 TSM, FM CD 5004 M, ZLL CD 5004 M

##### Thermoplastic (breakproof) high-gloss

ivory	 <b>CD 504 TSA</b>
white	 <b>CD 504 TSA WW</b>
grey	 <b>CD 504 TSA GR</b>
light grey	 <b>CD 504 TSA LG</b>
black	 <b>CD 504 TSA SW</b>



	Ref.-no.
<b>Transparent cover with paper inlay</b>	
(Spare part)	
to clip on F 50 push-button modules of the CD range	
ref.-no.: CD 507.. TSM, CD 509.. TSM, CD 509.. TSEM, CD 5178 TSM, CD 51.. KRM TS D, CD 5178 TSEM, CD 507.. RF TSM, CD 52.. TSM, FM CD 50.. M, ZLL CD 5004 M	
Also included in delivery of modules.	
inscription field 33 x 64 mm	
paper inlay pearly	<b>CD 50 NA</b>
<b>Neutral cover</b>	
to clip on F 50 push-button modules of the CD range	
ref.-no.: CD 507.. TSM, CD 509.. TSM, CD 509.. TSEM, CD 5178 TSM, CD 51.. KRM TS D, CD 5178 TSEM, CD 507.. RF TSM, CD 52.. TSM, FM CD 50.. M, ZLL CD 5004 M	
dimensions: 33 x 68 mm	
<b>Thermoplastic (breakproof) high-gloss</b>	
ivory	 <b>CD 50 NA W</b>
white	 <b>CD 50 NA WW</b>
grey	 <b>CD 50 NA GR</b>
light grey	 <b>CD 50 NA LG</b>
black	 <b>CD 50 NA SW</b>

**Professional inscription see [www.jung.de/gt](http://www.jung.de/gt)**

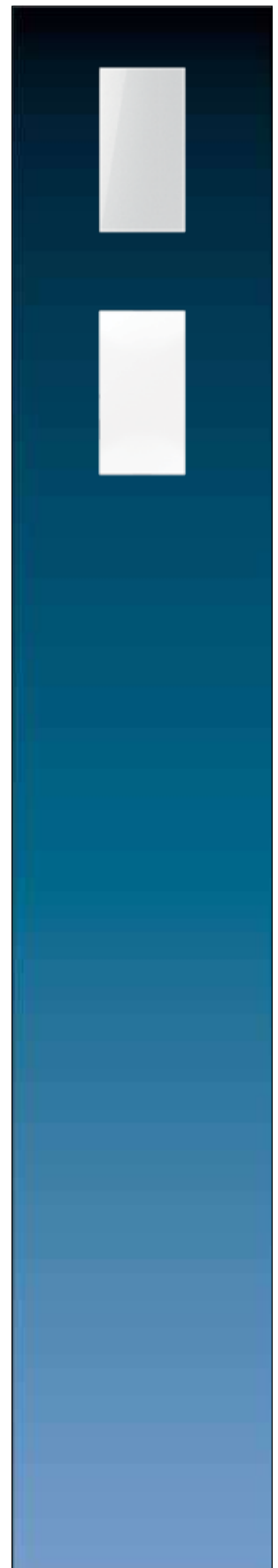



Ref.-no.

**Standard push-button module**

including transparent cover ref.-no.: LS 50 NA

**Intended use**

- Operation of loads, e.g. light on/off, dimming, blinds up/down, calling up and saving light scenes, etc.
- Installation in flush-box according to DIN 49073

**Product characteristics**

- Push-button functions for switching, dimming, blinds control, valuator, light scenes, etc.
- To be completed with cover kit
- Inscription field
- One red status LED for a pair of buttons
- One operation LED as orientation light and programming status – red, green or blue, adjustable
- Energy saving mode
- Integrated bus coupling unit
- Transparent cover kit (included) for temporary site use without design covers

**Standard push-button module, 1-gang**

for cover kit 1-gang, complete, ref.-no.: ..501 TSA .. in the LS range

ETS product family: Push-button

Product type: 1-gang push-button

**LS 5071 TSM****Standard push-button module, 2-gang**

for cover kit 2-gang, complete, ref.-no.: ..502 TSA .. in the LS range

ETS product family: Push-button

Product type: 2-gang push-button

**LS 5072 TSM****Standard push-button module, 3-gang**

for cover kit 3-gang, complete, ref.-no.: ..503 TSA .. in the LS range

ETS product family: Push-button

Product type: 3-gang push-button

**LS 5073 TSM****Standard push-button module, 4-gang**

for cover kit 4-gang, complete, ref.-no.: ..504 TSA .. in the LS range

ETS product family: Push-button

Product type: 4-gang push-button

**LS 5074 TSM**

Ref.-no.

### Universal push-button module

including transparent cover ref.-no.: LS 50 NA

#### Intended use

- Operation of loads, e.g. light on/off, dimming, blinds up/down, brightness values, temperatures, calling up and saving light scenes, etc.
- Installation in flush-box according to DIN 49073

#### Product characteristics

- Push-button functions for switching, dimming, blinds control, valuator, light scenes, etc.
- One or two functions per button
- To be completed with cover kit
- Inscription field can be illuminated
- One status LED per button, red, green or blue, adjustable
- One operation LED as orientation light and programming status – red, green or blue, adjustable
- Brightness of status LED, operation LED and inscription field adjustable, can be changed during operation, e.g. during night times
- Measurement of room temperature
- Extension unit for room temperature controller
- Disabling function: Disabling or change function mode of single or all button functions
- Alarm function, optional acknowledge by pressing any button
- Energy saving mode
- Integrated bus coupling unit
- Connection for a push-button extension module, 1-4 gang
- Transparent cover kit (included) for temporary site use without design covers

### Universal push-button module, 1-gang

for cover kit 1-gang, complete, ref.-no.: ..501 TSA .. in the LS range

can be extended by means of a push-button extension module, ref.-no.: LS 509.. TSEM

ETS product family: Push-button

Product type: 1-gang push-button

**LS 5091 TSM**

### Universal push-button module, 2-gang

for cover kit 2-gang, complete, ref.-no.: ..502 TSA .. in the LS range

can be extended by means of a push-button extension module, ref.-no.: LS 509.. TSEM

ETS product family: Push-button

Product type: 2-gang push-button

**LS 5092 TSM**

### Universal push-button module, 3-gang

for cover kit 3-gang, complete, ref.-no.: ..503 TSA .. in the LS range

can be extended by means of a push-button extension module, ref.-no.: LS 509.. TSEM

ETS product family: Push-button

Product type: 3-gang push-button

**LS 5093 TSM**

### Universal push-button module, 4-gang

for cover kit 4-gang, complete, ref.-no.: ..504 TSA .. in the LS range

can be extended by means of a push-button extension module, ref.-no.: LS 509.. TSEM

ETS product family: Push-button

Product type: 4-gang push-button

**LS 5094 TSM**







Ref.-no.

**Room temperature controller module 2-gang**

including transparent cover and inlay with symbols  
for cover kit 2-gang, complete, ref.-no.: ..502 TSA .. in the LS range

**LS 5178 TSM****Intended use**

- Single-room temperature control in KNX installations
- Operation of loads, e.g. light on/off, dimming, blinds up/down, recalling and saving light scenes, etc.
- Installation in wall box according to DIN 49073

**Product characteristics**

All buttons can be assigned with push-button sensor functions or functions for controller operation.

- Measurement of the room temperature
- Room temperature control with setpoint value specification
- Extension for room temperature controller
- Push-button functions switching, dimming, blind control, value transmitter, scene recall, etc.
- One or two functions per button
- Completion with cover kit 2-gang
- Illuminable inscription field
- Two red status LEDs per button – red, green or blue adjustable
- One operation LED as an orientation light and to indicate the programming status – red, green or blue adjustable
- Brightness of status LED, operation LED and labelling field adjustable; switchable while in operation, e.g. during the night
- Disabling function: Disable or function switch-over of all or of individual push-button functions
- Alarm function, optionally with confirmation by pressing any button
- Energy saving mode (for operation without controller function)
- Integrated bus coupling unit
- Connection for a push-button extension module, for extension with up to eight additional buttons

**Push-button extension module**

including transparent cover ref.-no.: LS 50 NA

for the extension of the Universal push-button module (ref.-no.: LS 509.. TSM) and room temperature controller module (ref.-no.: LS 5178 TSM) with up to 4 additional push-buttons

1-gang	<b>LS 5091 TSEM</b>
2-gang	<b>LS 5092 TSEM</b>
3-gang	<b>LS 5093 TSEM</b>
4-gang	<b>LS 5094 TSEM</b>

**Product characteristics**

- One or two functions per button
- To be completed with cover kit
- Inscription field can be illuminated
- One status LED per button, red, green or blue, adjustable
- One operation LED as orientation light and programming status – red, green or blue, adjustable
- Brightness of status LED, operation LED and inscription field adjustable, can be changed during operation, e.g. during night times
- Measurement of room temperature
- Extension unit for room temperature controller
- Disabling function: Disabling or change function mode of single or all button functions
- Alarm function, optional acknowledge by pressing any button
- Energy saving mode
- Transparent cover kit (included) for temporary site use without design covers
- Cable lengths: max. 30 m, cable type: J-Y(St)Y 2 x 2 x 0.8 mm<sup>2</sup>

Ref.-no.

### Room controller display compact module 2-gang

for cover kit 2-gang, complete, ref.-no.: ..502 TSA .. in the LS range

can be extended by means of a room controller

extension module, ref.-no: LS 5178 TSEM

can be extended by means of a push-button extension module, ref.-no.: LS 509.. TSEM

**LS 5192 KRM TS D**

recommended mounting height: 1.5 m

### Room controller display compact module 4-gang

for cover kit 4-gang, complete, ref.-no.: ..504 TSA .. in the LS range

can be extended by means of a room controller

extension module, ref.-no: LS 5178 TSEM

can be extended by means of a push-button extension module, ref.-no.: LS 509.. TSEM

**LS 5194 KRM TS D**

recommended mounting height: 1.5 m

#### Intended use

- Measurement and feedback control of the room temperature
- Operation of loads, e.g. light on/off, dimming, blinds up/down, brightness values, temperatures, calling up and saving light scenes, etc.
- Installation in wall box according to DIN 49073

#### Product characteristics

Each button can be used for push-button sensor of controller functions.

- Backlit LC display
- One or two functions per button
- To be completed with cover kit
- Eight status LED – red, green or blue
- Brightness of status LED and LCD adjustable
- Integrated bus coupling unit
- Connection of extension modules
- Integrated room temperature sensor
- External sensor (ref.-no.: FF 7.8) can be connected
- Room temperature control with setpoint value specification
- Two internal independent controllers for two independent areas – in connection with extension modules
- Display of room or set temperature (°C or °F)
- Display of outdoor temperature – with external sensor, e.g. weather station
- Display of time, in conjunction with KNX time encoder
- Push-button function or rocker function
- Inhibit function: blocking or change of function of the entire or single button functions
- Alarm function, optional with acknowledge by pressing any button
- Function symbols can be shown

### Room controller extension module 2-gang

for cover kit 2-gang, complete, ref.-no.: ..502 TSA .. in the LS range

for the extension of a room controller module (ref.-no.: LS 5192 KRM TS D, LS 5194 KRM TS D)

with a second room temperature control unit

**LS 5178 TSEM**

#### Intended use

- Operation of loads, e.g. light on/off, dimming, blinds up/down, brightness values, temperatures, calling up and saving light scenes, etc.
- Measurement of room temperature
- Extension for room controller modules (.. 5192 KRM TS D, .. 5194 KRM TS D)
- Installation in wall box according to DIN 49073
- Cable lengths: max. 30 m, cable type: J-Y(St)Y 2 x 2 x 0.8 mm<sup>2</sup>



Delivery of cover kits:  
1 complete set per ref.-no.!



Ref.-no.

**Cover kit 1-gang**

to clip on F50 push-button modules 1-gang of the LS range

ref.-no.: LS 5071 TSM, LS 5091 TSM, LS 5091 TSEM, LS 5071 RF TSM, LS 5212 TSM, FM LS 5001 M

**Thermoplastic (breakproof) high-gloss**

ivory		<b>LS 501 TSA</b>
white		<b>LS 501 TSA WW</b>
light grey		<b>LS 501 TSA LG</b>
black		<b>LS 501 TSA SW</b>

**metal versions**

aluminium		<b>AL 2501 TSA</b>
stainless steel		<b>ES 2501 TSA</b>
anthracite (aluminium lacquered)		<b>AL 2501 TSA AN</b>
dark (aluminium lacquered)		<b>AL 2501 TSA D</b>
chrome		<b>GCR 2501 TSA</b>
gold-coloured		<b>GO 2501 TSA</b>
gold-plated		<b>LS 501 TSA GGO</b>
classic brass		<b>ME 2501 TSA C</b>
antique brass		<b>ME 2501 TSA AT</b>

**Cover kit 2-gang**

to clip on F50 push-button modules 2-gang of the LS range

ref.-no.: LS 5072 TSM, LS 5092 TSM, LS 5092 TSEM, LS 5178 TSM, LS 5192 KRM TS D, LS 5178 TSEM, LS 5072 RF TSM, LS 5224 TSM, FM LS 5002 M

**Thermoplastic (breakproof) high-gloss**

ivory		<b>LS 502 TSA</b>
white		<b>LS 502 TSA WW</b>
light grey		<b>LS 502 TSA LG</b>
black		<b>LS 502 TSA SW</b>

**metal versions**

aluminium		<b>AL 2502 TSA</b>
stainless steel		<b>ES 2502 TSA</b>
anthracite (aluminium lacquered)		<b>AL 2502 TSA AN</b>
dark (aluminium lacquered)		<b>AL 2502 TSA D</b>
chrome		<b>GCR 2502 TSA</b>
gold-coloured		<b>GO 2502 TSA</b>
gold-plated		<b>LS 502 TSA GGO</b>
classic brass		<b>ME 2502 TSA C</b>
antique brass		<b>ME 2502 TSA AT</b>

**Cover kit 3-gang**

to clip on F50 push-button modules 3-gang of the LS range

ref.-no.: LS 5073 TSM, LS 5093 TSM, LS 5093 TSEM, LS 5073 RF TSM, LS 5236 TSM, FM LS 5003 M, SI TM LS 5073, SI TM LS 5093

**Thermoplastic (breakproof) high-gloss**

ivory		<b>LS 503 TSA</b>
white		<b>LS 503 TSA WW</b>
light grey		<b>LS 503 TSA LG</b>
black		<b>LS 503 TSA SW</b>

**metal versions**

aluminium		<b>AL 2503 TSA</b>
stainless steel		<b>ES 2503 TSA</b>
anthracite (aluminium lacquered)		<b>AL 2503 TSA AN</b>
dark (aluminium lacquered)		<b>AL 2503 TSA D</b>
chrome		<b>GCR 2503 TSA</b>
gold-coloured		<b>GO 2503 TSA</b>
gold-plated		<b>LS 503 TSA GGO</b>
classic brass		<b>ME 2503 TSA C</b>
antique brass		<b>ME 2503 TSA AT</b>

**P** Colour printing possible

**L** Laser labelling possible

Ref.-no.

### Cover kit 4-gang

to clip on F50 push-button modules 4-gang of the LS range

ref.-no.: LS 5074 TSM, LS 5094 TSM, LS 5094 TSEM, LS 5194 KRM TS D, LS 5074 RF TSM, LS 5248 TSM, FM LS 5004 M, ZLL LS 5004 M

#### Thermoplastic (breakproof) high-gloss

ivory	<b>L</b>	<b>LS 504 TSA</b>
white	<b>L</b>	<b>LS 504 TSA WW</b>
light grey	<b>L</b>	<b>LS 504 TSA LG</b>
black	<b>L</b>	<b>LS 504 TSA SW</b>

#### metal versions

aluminium	<b>P</b> <b>L</b>	<b>AL 2504 TSA</b>
stainless steel	<b>L</b>	<b>ES 2504 TSA</b>
anthracite (aluminium lacquered)	<b>L</b>	<b>AL 2504 TSA AN</b>
dark (aluminium lacquered)	<b>L</b>	<b>AL 2504 TSA D</b>
chrome		<b>GCR 2504 TSA</b>
gold-coloured		<b>GO 2504 TSA</b>
gold-plated		<b>LS 504 TSA GGO</b>
classic brass	<b>P</b>	<b>ME 2504 TSA C</b>
antique brass		<b>ME 2504 TSA AT</b>

### Transparent cover with paper inlay

(Spare part)

to clip on F50 push-button modules of the LS range

ref.-no.: LS 507.. TSM, LS 509.. TSM, LS 509.. TSEM, LS 5178 TSM, LS 51.. KRM TS D, LS 5178 TSEM, LS 507.. RF TSM, LS 52.. TSM, FM LS 50.. M, ZLL LS 5004 M

Also included in delivery of modules.

inscription field 33 x 67.5 mm

paper inlay pearly	<b>LS 50 NA</b>
--------------------	-----------------

### Neutral cover

to clip on F50 push-button modules of the LS range

ref.-no.: LS 507.. TSM, LS 509.. TSM, LS 509.. TSEM, LS 5178 TSM, LS 51.. KRM TS D, LS 5178 TSEM, LS 507.. RF TSM, LS 52.. TSM, FM LS 50.. M, ZLL LS 5004 M

dimensions: 33 x 70.5 mm

#### Thermoplastic (breakproof) high-gloss

ivory	<b>L</b>	<b>LS 50 NA W</b>
white	<b>L</b>	<b>LS 50 NA WW</b>
light grey	<b>L</b>	<b>LS 50 NA LG</b>
black	<b>L</b>	<b>LS 50 NA SW</b>

#### metal versions

aluminium (lacquered)	<b>P</b>	<b>AL 50 NA-L</b>
stainless steel (lacquered)	<b>P</b>	<b>ES 50 NA-L</b>
anthracite (lacquered)		<b>AL 50 NA AN-L</b>
dark (lacquered)		<b>AL 50 NA D-L</b>
classic brass (lacquered)	<b>P</b>	<b>ME 50 NA C-L</b>
antique brass (lacquered)		<b>ME 50 NA AT-L</b>

**Professional inscription see [www.jung.de/gt](http://www.jung.de/gt)**







**PUSH-BUTTON SENSOR F 40**

LS 990 in stainless steel

Easy operating concept meets straight line design: The KNX sensors of the F 40 family focussed on large, square control buttons for comfortable handling.

# The F 40 family

## PUSH-BUTTON SENSORS

Thanks to the large-area buttons, a simple and comfortable operating concept for control of functions and scenes is produced for 1 to 4-gang F 40 push-button sensors.



## PUSH-BUTTON SENSORS RF

KNX RF is the manufacturer-independent KNX wireless standard. The RF push-button sensors have the same operating concept and design as the well-known push-button sensors with twisted pair connection.



## COMPACT ROOM CONTROLLER

With three control panels for switching, dimming or blind control. The preset functions are executed using the markings on the left and right on the display; the buttons can be freely parametrised.



## ROOM CONTROLLER OLED

This room controller has a high resolution graphical display with brilliant presentation including plain text display. In accordance with the F 40 concept, the handling is also performed using the large-area buttons.





**PUSH-BUTTON SENSOR F 40**  
LS 990 surface-mounted design in aluminium

# Individual button assignment

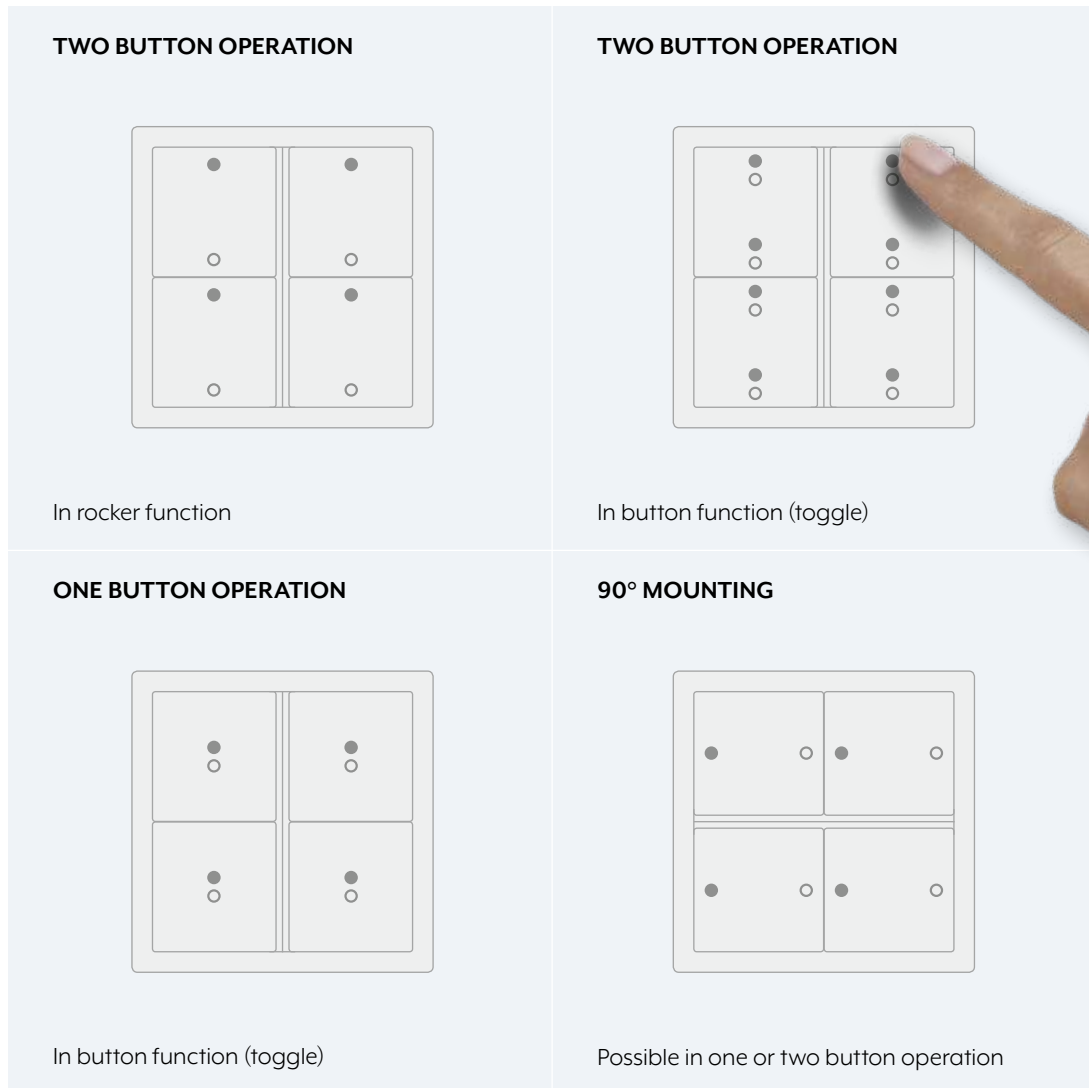

One button or two button operation can be set as operating modes for the F 40 push-button sensors. One operating button can be configured in each case as rocker or button. For the rocker function, an operating button is divided into two operating pressure points with the same basic function. In contrast for the button function, an operating button is evaluated in two operating points with two individually parameterisable functions. Horizontal mounting can also be realised.



With regard to design and operating concept, the F 40 push button sensors come close to a conventional switch. This also makes the handling easy for users not used to KNX. The large areas can be labelled easily and clearly recognisable that further optimises the operation using the Graphic Tool.

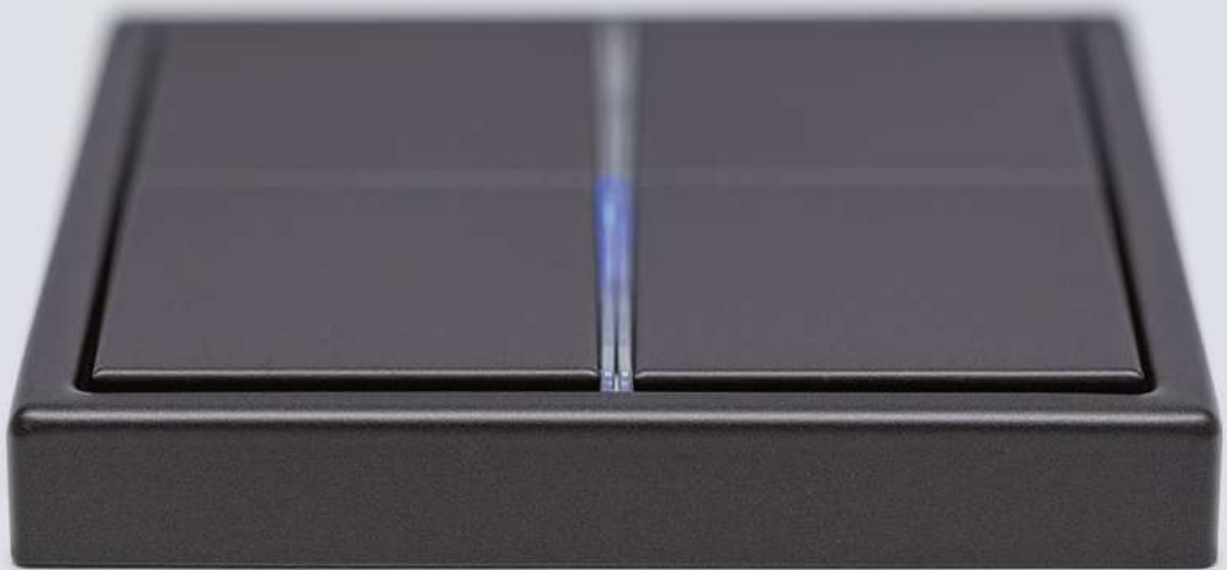

**PUSH-BUTTON SENSOR F 40**

LS 990 in Dark

# Versatile functionality

## EXTENSION MODULE CONNECTION\*

The flat push-button extension module can be directly connected to the main module for flexible extension of the functions. It is mounted in a 2-gang frame using a special supporting ring. Advantage also for the retrofitting. No separate flush-mounted box is needed.



## THE CONSTRUCTION SITE COVERAGE

Thanks to the construction site coverage, button and function assignment can already be realised in construction site operation. The decision for button and cover design thus has time until the project acceptance.



## PUSH-BUTTON QUICK MOUNTING

The operating buttons are provided as complete Cover kit on a mounting aid for quick mounting. Each button can also be individually replaced, e.g. for a laser-cut or printed version.



## INTEGRATED: THE TEMPERATURE SENSOR\*

The temperature at a different place in the room can be measured with the temperature sensor. The values are transmitted to the room temperature controller or room controller for effective control.

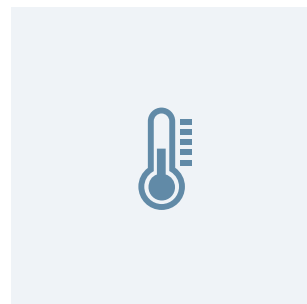

## ILLUMINATING: THE LIGHTING SCENE MEMORY\*

Up to eight light scenes can be stored in the integrated light scene memory; in turn, eight groups can be assigned to each scene. They can be recalled using the buttons or other KNX commands.

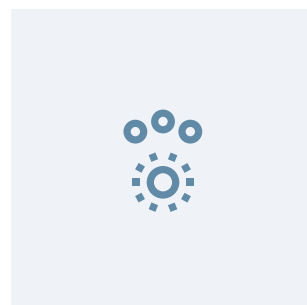

\* only for Universal version



**PUSH-BUTTON SENSOR F 40**  
LS ZERO in aluminium

## Variety of designs

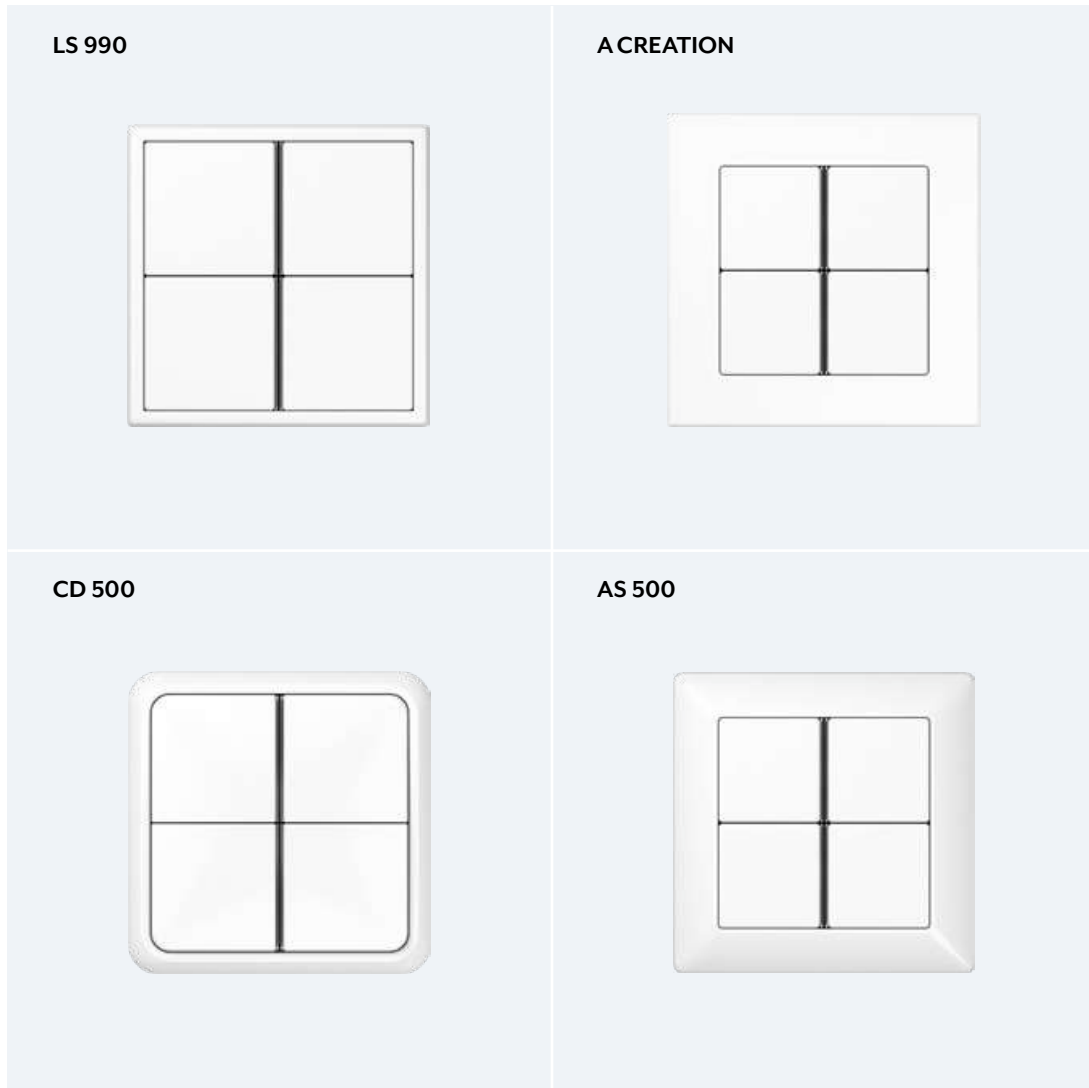

The AS, A, CD and LS ranges give the KNX sensors of the F 40 family their attractive appearance. Genuine materials, distinctive forms and a wide variety of colours determine the JUNG design. They can be matched to any ambiance.



# F 40 – numerous combination possibilities

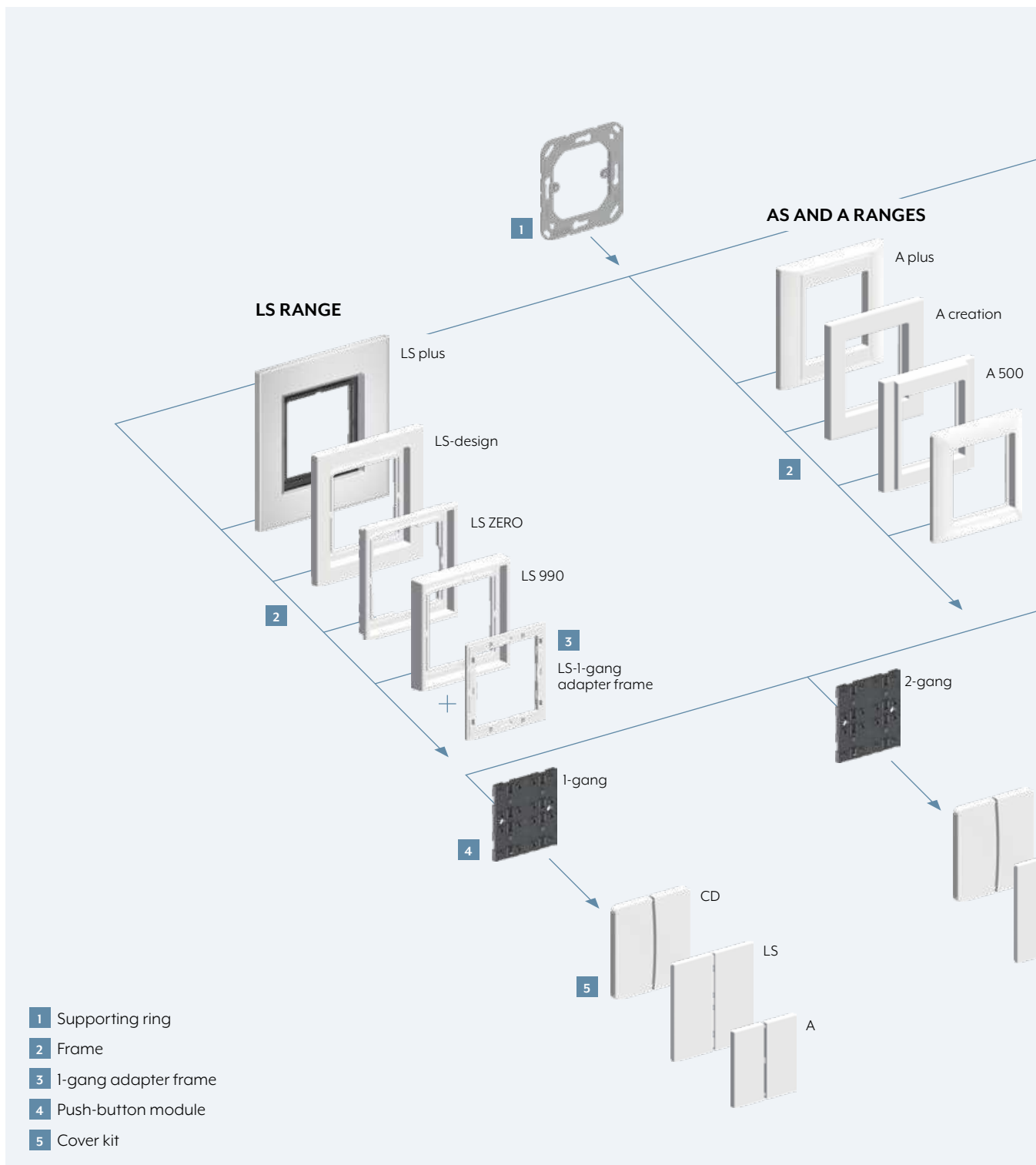

Flexibility for the planning: There are identical modules as basis for all design variants for the F 40 sensors. Thus, the switch program can even still be selected after the mounting. The corresponding Cover kits and frames are available in the JUNG design ranges.

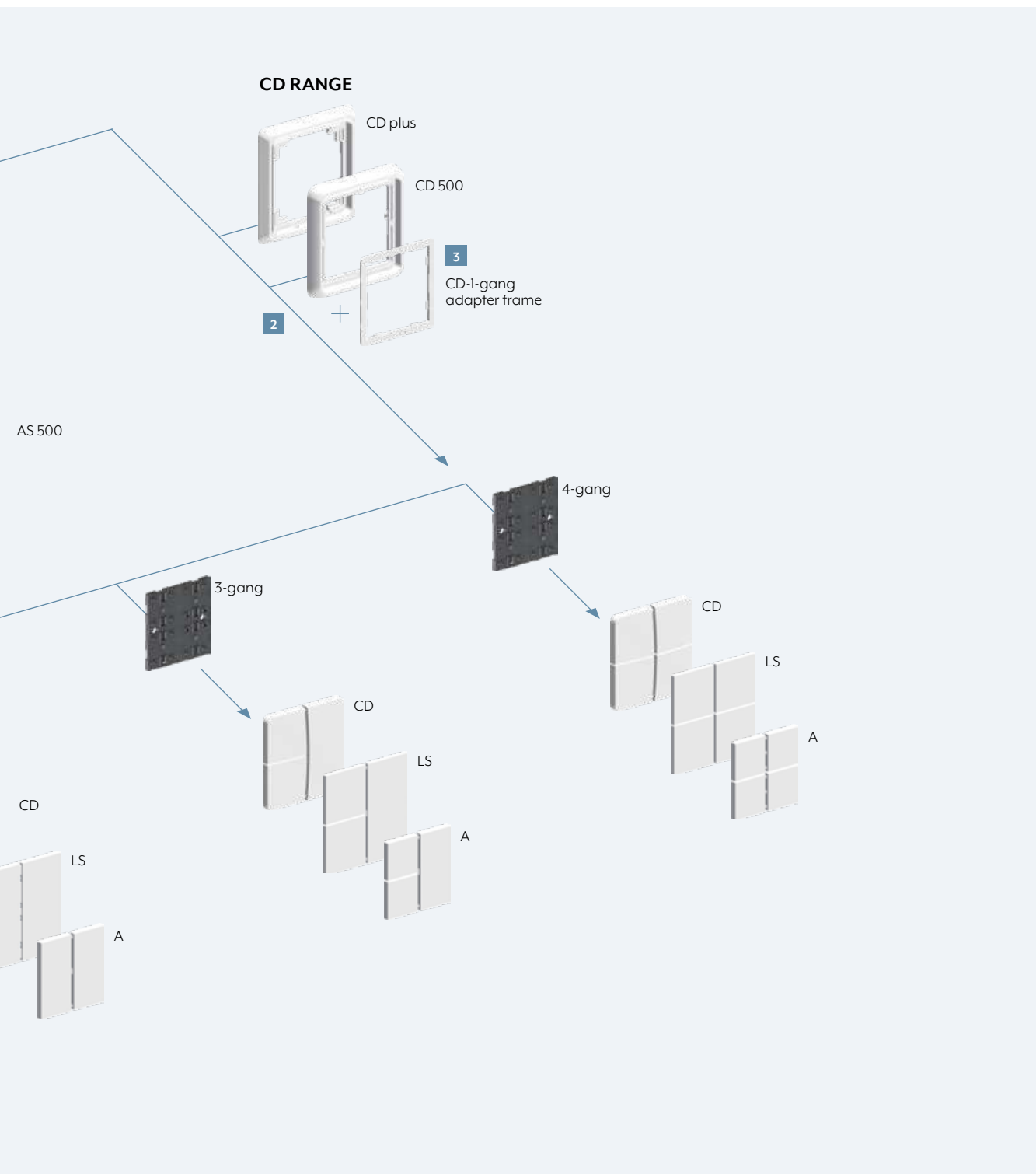

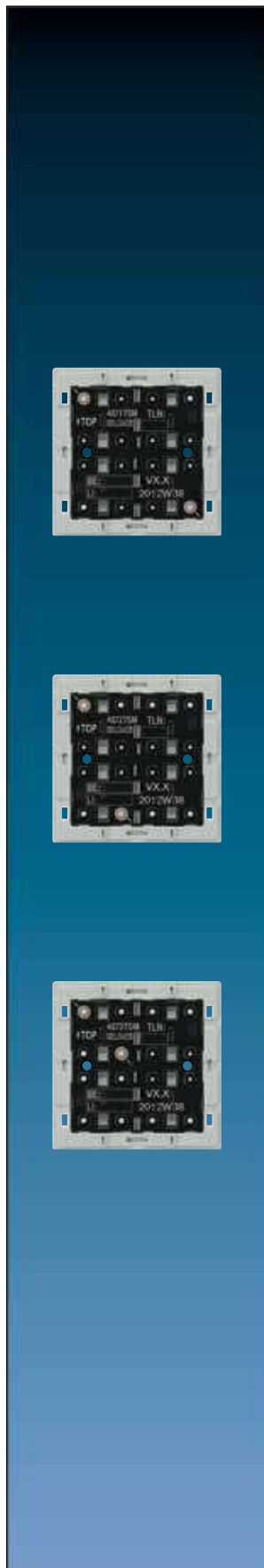

Ref.-no.

**Standard push-button module****Intended use**

- Operation of loads, e.g. light on/off, dimming, blinds up/down, calling up and saving light scenes, etc.
- Installation in flush-box according to DIN 49073

**Product characteristics**

- Push-button functions for switching, dimming, blinds control, valuator, light scenes, etc.
- To be completed with cover kit
- One red status LED per button
- One blue operation LED as an orientation light and to indicate the programming status
- Integrated bus coupling unit
- Transparent cover kit (included) for temporary site use without design covers

**Standard push-button module, 1-gang**

for cover kit 1-gang, complete, ref.-no.: .. 401 TSA ..

for cover 1-gang with symbols, ref.-no.: .. 401 TSAP ..

Adapter frames are included in delivery: ref.-no. LS 4 AR for LS range (pre-mounted)

and ref.-no. CD 4 AR for CD range. AS / A ranges without adapter frame.

Only with the ETS 3.0d version or later versions the full functionality will be available.

ETS product family: Push-button

Product type: 1-gang push-button

1 blue LED: operation indication

1 red LED: status indication

**4071 TSM****Standard push-button module, 2-gang**

for cover kit 2-gang, complete, ref.-no.: .. 402 TSA ..

for cover 2-gang with symbols, ref.-no.: .. 402 TSAP ..

Adapter frames are included in delivery: ref.-no. LS 4 AR for LS range (pre-mounted)

and ref.-no. CD 4 AR for CD range. AS / A ranges without adapter frame.

Only with the ETS 3.0d version or later versions the full functionality will be available.

ETS product family: Push-button

Product type: 2-gang push-button

1 blue LED: operation indication

2 red LED: status indication

**4072 TSM****Standard push-button module, 3-gang**

for cover kit 3-gang, complete, ref.-no.: .. 403 TSA ..

for cover 2-gang with symbols, ref.-no.: .. 402 TSAP ..

for cover 4-gang with symbols, ref.-no.: .. 404 TSAP ..

Adapter frames are included in delivery: ref.-no. LS 4 AR for LS range (pre-mounted)

and ref.-no. CD 4 AR for CD range. AS / A ranges without adapter frame.

Only with the ETS 3.0d version or later versions the full functionality will be available.

ETS product family: Push-button

Product type: 3-gang push-button

1 blue LED: operation indication

3 red LED: status indication

**4073 TSM**

Ref.-no.

### Standard push-button module, 4-gang

for cover kit 4-gang, complete, ref.-no.: .. 404 TSA ..

for cover 4-gang with symbols, ref.-no.: .. 404 TSAP ..

Adapter frames are included in delivery: ref.-no. LS 4 AR for LS range (pre-mounted) and ref.-no. CD 4 AR for CD range. AS / A ranges without adapter frame.

Only with the ETS 3.0d version or later versions the full functionality will be available.

ETS product family: Push-button

Product type: 4-gang push-button

1 blue LED: operation indication

4 red LED: status indication

**4074 TSM**

### Universal push-button module

#### Intended use

- Operation of loads, e.g. light on/off, dimming, blinds up/down, brightness values, temperatures, calling up and saving light scenes, etc.
- Installation in flush-box according to DIN 49073

#### Product characteristics

- Push-button functions for switching, dimming, blinds control, valuator, light scenes, etc.
- Measurement of room temperature
- To be completed with cover kit
- Two red status LED per button
- One blue operation LED as an orientation light and to indicate the programming status
- Integrated bus coupling unit
- One, two or three functions per button
- Push-button function or rocker function, vertical or horizontal
- Connection for a push-button extension module, 1-4 gang
- Transparent cover kit (included) for temporary site use without design covers

### Universal push-button module, 1-gang

for cover kit 1-gang, complete, ref.-no.: .. 401 TSA ..

for cover 1-gang with symbols, ref.-no.: .. 401 TSAP ..

can be extended by means of a push-button extension module, ref.-no.: 409.. TSEM

Adapter frames are included in delivery: ref.-no. LS 4 AR for LS range (pre-mounted) and ref.-no. CD 4 AR for CD range. AS / A ranges without adapter frame.

Only with the ETS 3.0d version or later versions the full functionality will be available.

ETS product family: Push-button

Product type: 1-gang push-button

1 blue LED: operation indication

2 red LED: status indication

**4191 TSM**

### Universal push-button module, 2-gang

for cover kit 2-gang, complete, ref.-no.: .. 402 TSA ..

for cover 2-gang with symbols, ref.-no.: .. 402 TSAP ..

can be extended by means of a push-button extension module, ref.-no.: 409.. TSEM

Adapter frames are included in delivery: ref.-no. LS 4 AR for LS range (pre-mounted) and ref.-no. CD 4 AR for CD range. AS / A ranges without adapter frame.

Only with the ETS 3.0d version or later versions the full functionality will be available.

ETS product family: Push-button

Product type: 2-gang push-button

1 blue LED: operation indication

4 red LED: status indication

**4192 TSM**

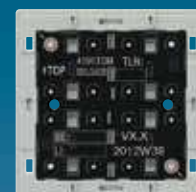



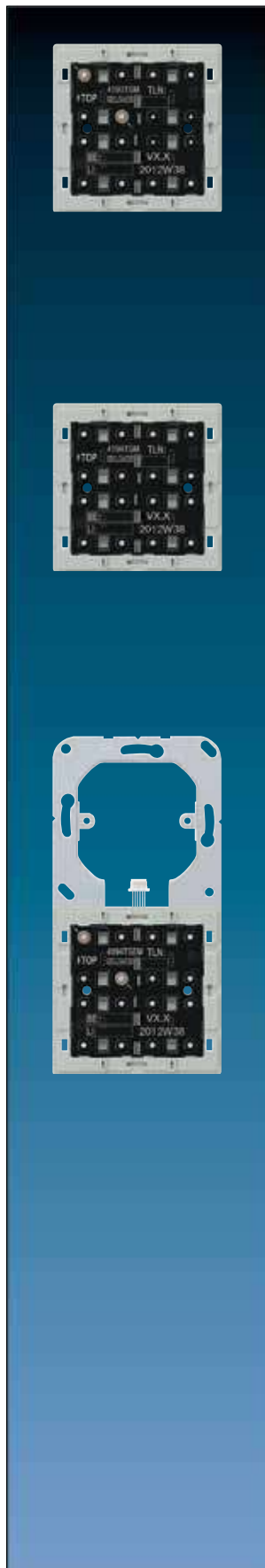

Ref.-no.

**Universal push-button module, 3-gang**

for cover kit 3-gang, complete, ref.-no.: .. 403 TSA ..  
 for cover 2-gang with symbols, ref.-no.: .. 402 TSAP ..  
 for cover 4-gang with symbols, ref.-no.: .. 404 TSAP ..  
 can be extended by means of a push-button extension module, ref.-no.: 409.. TSEM  
 Adapter frames are included in delivery: ref.-no. LS 4 AR for LS range (pre-mounted)  
 and ref.-no. CD 4 AR for CD range. AS / A ranges without adapter frame.  
 Only with the ETS 3.0d version or later versions the full functionality will be available.  
 ETS product family: Push-button  
 Product type: 3-gang push-button  
 1 blue LED: operation indication  
 6 red LED: status indication

**4193 TSM**

**Universal push-button module, 4-gang**

for cover kit 4-gang, complete, ref.-no.: .. 404 TSA ..  
 for cover 4-gang with symbols, ref.-no.: .. 404 TSAP ..  
 can be extended by means of a push-button extension module, ref.-no.: 409.. TSEM  
 Adapter frames are included in delivery: ref.-no. LS 4 AR for LS range (pre-mounted)  
 and ref.-no. CD 4 AR for CD range. AS / A ranges without adapter frame.  
 Only with the ETS 3.0d version or later versions the full functionality will be available.  
 ETS product family: Push-button  
 Product type: 4-gang push-button  
 1 blue LED: operation indication  
 8 red LED: status indication

**4194 TSM**

**Push-button extension module**

for the extension of up to 4 additional push-buttons for the devices:  
 • Universal push-button module (ref.-no. 419.. TSM)  
 • Room controller display compact module (ref.-no. 4093 KRM TS D)  
 • Room controller display module 2-gang (ref.-no. RCD .. 4092 M)  
 • Smart Control KNX (ref.-no. SC 1000 KNX)  
 preferred installation: vertical  
 Adapter frames are included in delivery: ref.-no. LS 4 AR for LS range (pre-mounted)  
 and ref.-no. CD 4 AR for CD range. AS / A ranges without adapter frame.  
 red LED: status indication

1-gang	<b>4091 TSEM</b>
2-gang	<b>4092 TSEM</b>
3-gang	<b>4093 TSEM</b>
4-gang	<b>4094 TSEM</b>

**P** Colour printing possible

**L** Laser labelling possible

Delivery of cover kits:

1 complete set per ref.-no.!

Ref.-no.

## Cover kits for AS and A ranges

### Cover kit 1-gang

to clip on F 40 push-button modules 1-gang

ref.-no.: 4071 TSM, 4191 TSM, 4091 TSEM, 4071 RF TSM, 4212 TSM, 4008 TSM, FM 4001 M

#### Thermoplastic (breakproof) high-gloss

ivory	<b>L</b>	<b>A 401 TSA</b>
white	<b>L</b>	<b>A 401 TSA WW</b>
black	<b>L</b>	<b>A 401 TSA SW</b>

#### Thermoplastic (breakproof) lacquered

aluminium	<b>P</b> <b>L</b>	<b>A 401 TSA AL</b>
champagne	<b>P</b>	<b>A 401 TSA CH</b>
mocha		<b>A 401 TSA MO</b>
matt anthracite	<b>L</b>	<b>A 401 TSA ANM</b>

### Cover kit 2-gang

to clip on F 40 push-button modules 2-gang

ref.-no.: 4072 TSM, 4192 TSM, 4092 TSEM, 4072 RF TSM, 4224 TSM, 4008 TSM, FM 4002 M

#### Thermoplastic (breakproof) high-gloss

ivory	<b>L</b>	<b>A 402 TSA</b>
white	<b>L</b>	<b>A 402 TSA WW</b>
black	<b>L</b>	<b>A 402 TSA SW</b>

#### Thermoplastic (breakproof) lacquered

aluminium	<b>P</b> <b>L</b>	<b>A 402 TSA AL</b>
champagne	<b>P</b>	<b>A 402 TSA CH</b>
mocha		<b>A 402 TSA MO</b>
matt anthracite	<b>L</b>	<b>A 402 TSA ANM</b>

### Cover kit 3-gang

to clip on F 40 push-button modules 3-gang

ref.-no.: 4073 TSM, 4193 TSM, 4093 TSEM, 4073 RF TSM, 4236 TSM, 4008 TSM, FM 4003 M

#### Thermoplastic (breakproof) high-gloss

ivory	<b>L</b>	<b>A 403 TSA</b>
white	<b>L</b>	<b>A 403 TSA WW</b>
black	<b>L</b>	<b>A 403 TSA SW</b>

#### Thermoplastic (breakproof) lacquered

aluminium	<b>P</b> <b>L</b>	<b>A 403 TSA AL</b>
champagne	<b>P</b>	<b>A 403 TSA CH</b>
mocha		<b>A 403 TSA MO</b>
matt anthracite	<b>L</b>	<b>A 403 TSA ANM</b>

### Cover kit 4-gang

to clip on F 40 push-button modules 4-gang

ref.-no.: 4074 TSM, 4194 TSM, 4094 TSEM, 4074 RF TSM, 4248 TSM, 4008 TSM, FM 4004 M

#### Thermoplastic (breakproof) high-gloss

ivory	<b>L</b>	<b>A 404 TSA</b>
white	<b>L</b>	<b>A 404 TSA WW</b>
black	<b>L</b>	<b>A 404 TSA SW</b>

#### Thermoplastic (breakproof) lacquered

aluminium	<b>P</b> <b>L</b>	<b>A 404 TSA AL</b>
champagne	<b>P</b>	<b>A 404 TSA CH</b>
mocha		<b>A 404 TSA MO</b>
matt anthracite	<b>L</b>	<b>A 404 TSA ANM</b>

**Professional laser inscription and colour printing!**

**For further information see [www.jung.de/gt](http://www.jung.de/gt)**



Delivery of cover kits:  
1 complete set per ref.-no.!

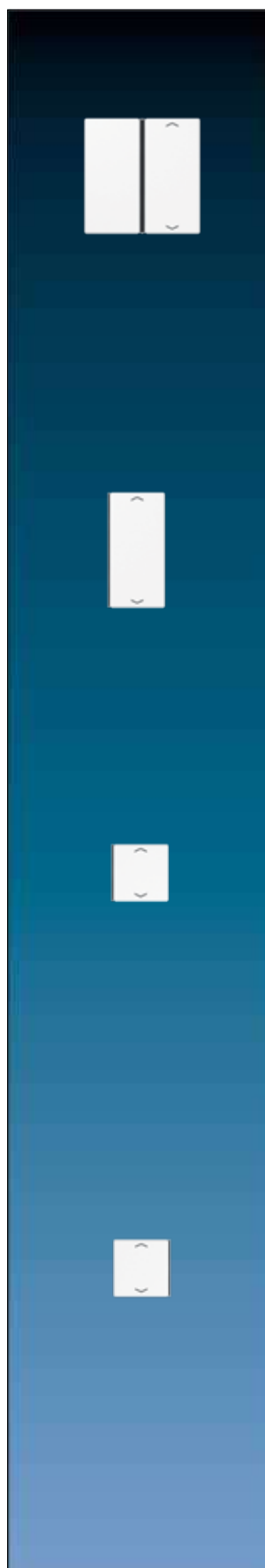

Ref.-no.

### Covers with symbols for AS and A ranges

#### Cover 1-gang with symbols ▲▼

to clip on F 40 push-button modules 1-gang  
ref.-no.: 4071 TSM, 4191 TSM, 4091 TSEM, 4071 RF TSM, 4212 TSM, 4008 TSM, FM 4001 M

#### Thermoplastic (breakproof) high-gloss

ivory	A 401 TSAP
white	A 401 TSAP WW
black	A 401 TSAP SW

#### Thermoplastic (breakproof) lacquered

aluminium	A 401 TSAP AL
champagne	A 401 TSAP CH
mocha	A 401 TSAP MO
matt anthracite	A 401 TSAP ANM

#### Cover 2-gang with symbols ▲▼

to exchange the covers of the cover kit 2-gang ref.-no.: A 402 TSA..  
and the right cover of the cover kit 3-gang ref.-no.: A 403 TSA..

#### Thermoplastic (breakproof) high-gloss

ivory	A 402 TSAP
white	A 402 TSAP WW
black	A 402 TSAP SW

#### Thermoplastic (breakproof) lacquered

aluminium	A 402 TSAP AL
champagne	A 402 TSAP CH
mocha	A 402 TSAP MO
matt anthracite	A 402 TSAP ANM

#### Cover 4-gang with symbols ▲▼

to exchange the top left cover of the cover kit 3-gang ref.-no.: A 403 TSA..  
and top left and bottom right cover of the cover kit 4-gang ref.-no.: A 404 TSA..

#### Thermoplastic (breakproof) high-gloss

ivory	A 404 TSAP 14
white	A 404 TSAP WW 14
black	A 404 TSAP SW 14

#### Thermoplastic (breakproof) lacquered

aluminium	A 404 TSAP AL 14
champagne	A 404 TSAP CH 14
mocha	A 404 TSAP MO 14
matt anthracite	A 404 TSAP ANM 14

#### Cover 4-gang with symbols ▲▼

to exchange the bottom left cover of the cover kit 3-gang ref.-no.: A 403 TSA..  
and top right and bottom left cover of the cover kit 4-gang ref.-no.: A 404 TSA..

#### Thermoplastic (breakproof) high-gloss

ivory	A 404 TSAP 23
white	A 404 TSAP WW 23
black	A 404 TSAP SW 23

#### Thermoplastic (breakproof) lacquered

aluminium	A 404 TSAP AL 23
champagne	A 404 TSAP CH 23
mocha	A 404 TSAP MO 23
matt anthracite	A 404 TSAP ANM 23

**P** Colour printing possible

**L** Laser labelling possible

Ref.-no.

## Cover kits for CD range

### Cover kit 1-gang

to clip on F 40 push-button modules 1-gang

ref.-no.: 4071 TSM, 4191 TSM, 4091 TSEM, 4071 RF TSM, 4212 TSM, 4008 TSM, FM 4001 M

#### Thermoplastic (breakproof) high-gloss

ivory	<b>L</b> CD 401 TSA
white	<b>L</b> CD 401 TSA WW
grey	<b>L</b> CD 401 TSA GR
light grey	<b>L</b> CD 401 TSA LG
black	<b>L</b> CD 401 TSA SW

### Cover kit 2-gang

to clip on F 40 push-button modules 2-gang

ref.-no.: 4072 TSM, 4192 TSM, 4092 TSEM, 4072 RF TSM, 4224 TSM, 4008 TSM, FM 4002 M

#### Thermoplastic (breakproof) high-gloss

ivory	<b>L</b> CD 402 TSA
white	<b>L</b> CD 402 TSA WW
grey	<b>L</b> CD 402 TSA GR
light grey	<b>L</b> CD 402 TSA LG
black	<b>L</b> CD 402 TSA SW

### Cover kit 3-gang

to clip on F 40 push-button modules 3-gang

ref.-no.: 4073 TSM, 4193 TSM, 4093 TSEM, 4073 RF TSM, 4236 TSM, 4008 TSM, FM 4003 M

#### Thermoplastic (breakproof) high-gloss

ivory	<b>L</b> CD 403 TSA
white	<b>L</b> CD 403 TSA WW
grey	<b>L</b> CD 403 TSA GR
light grey	<b>L</b> CD 403 TSA LG
black	<b>L</b> CD 403 TSA SW

### Cover kit 4-gang

to clip on F 40 push-button modules 4-gang

ref.-no.: 4074 TSM, 4194 TSM, 4094 TSEM, 4074 RF TSM, 4248 TSM, 4008 TSM, FM 4004 M

#### Thermoplastic (breakproof) high-gloss

ivory	<b>L</b> CD 404 TSA
white	<b>L</b> CD 404 TSA WW
grey	<b>L</b> CD 404 TSA GR
light grey	<b>L</b> CD 404 TSA LG
black	<b>L</b> CD 404 TSA SW

**Professional laser inscription and colour printing!**

For further information see [www.jung.de/gt](http://www.jung.de/gt)





Delivery of cover kits:  
1 complete set per ref.-no.!

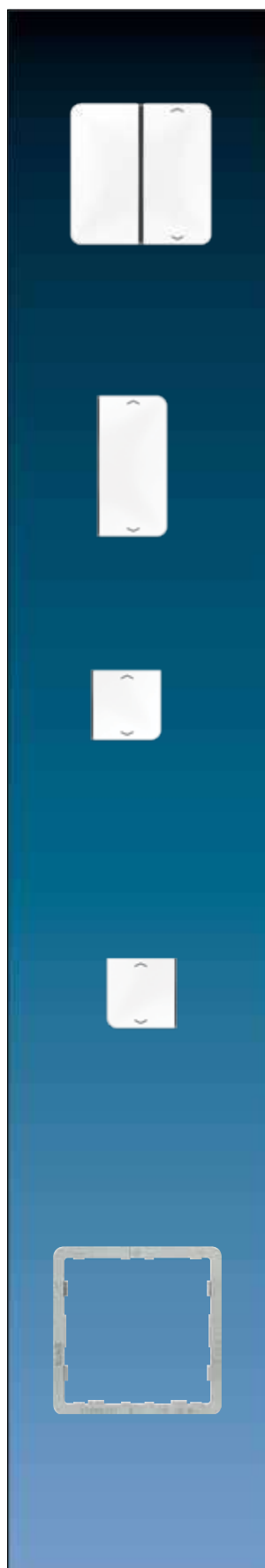

---

 Ref.-no.
 

---

### Covers with symbols for CD range

#### Cover 1-gang with symbols ▲▼

to clip on F 40 push-button modules 1-gang

ref.-no.: 4071 TSM, 4191 TSM, 4091 TSEM, 4071 RF TSM, 4212 TSM, 4008 TSM, FM 4001 M

#### Thermoplastic (breakproof) high-gloss

ivory	<b>CD 401 TSAP</b>
white	<b>CD 401 TSAP WW</b>
grey	<b>CD 401 TSAP GR</b>
light grey	<b>CD 401 TSAP LG</b>
black	<b>CD 401 TSAP SW</b>

#### Cover 2-gang with symbols ▲▼

to exchange the covers of the cover kit 2-gang ref.-no.: CD 402 TSA..

and the right cover of the cover kit 3-gang ref.-no.: CD 403 TSA..

#### Thermoplastic (breakproof) high-gloss

ivory	<b>CD 402 TSAP</b>
white	<b>CD 402 TSAP WW</b>
grey	<b>CD 402 TSAP GR</b>
light grey	<b>CD 402 TSAP LG</b>
black	<b>CD 402 TSAP SW</b>

#### Cover 4-gang with symbols ▲▼

to exchange the top left cover of the cover kit 3-gang ref.-no.: CD 403 TSA..

and top left and bottom right cover of the cover kit 4-gang ref.-no.: CD 404 TSA..

#### Thermoplastic (breakproof) high-gloss

ivory	<b>CD 404 TSAP 14</b>
white	<b>CD 404 TSAP WW 14</b>
grey	<b>CD 404 TSAP GR 14</b>
light grey	<b>CD 404 TSAP LG 14</b>
black	<b>CD 404 TSAP SW 14</b>

#### Cover 4-gang with symbols ▲▼

to exchange the bottom left cover of the cover kit 3-gang ref.-no.: CD 403 TSA..

and top right and bottom left cover of the cover kit 4-gang ref.-no.: CD 404 TSA..

#### Thermoplastic (breakproof) high-gloss

ivory	<b>CD 404 TSAP 23</b>
white	<b>CD 404 TSAP WW 23</b>
grey	<b>CD 404 TSAP GR 23</b>
light grey	<b>CD 404 TSAP LG 23</b>
black	<b>CD 404 TSAP SW 23</b>

#### Adapter frame

(Spare part)

to combine push-button modules with CD range

Also included in delivery of modules.

---

**CD 4 AR**

---

**P** Colour printing possible

**L** Laser labelling possible

Ref.-no.

## Cover kits for LS range

### Cover kit 1-gang

to clip on F 40 push-button modules 1-gang

ref.-no.: 4071 TSM, 4191 TSM, 4091 TSEM, 4071 RF TSM, 4212 TSM, 4008 TSM, FM 4001 M

#### Thermoplastic (breakproof) high-gloss

ivory	<b>L</b>	LS 401 TSA
white	<b>L</b>	LS 401 TSA WW
light grey	<b>L</b>	LS 401 TSA LG
black	<b>L</b>	LS 401 TSA SW

#### metal versions

aluminium	<b>P</b> <b>L</b>	AL 2401 TSA
stainless steel	<b>L</b>	ES 2401 TSA
anthracite (aluminium lacquered)	<b>L</b>	AL 2401 TSA AN
dark (aluminium lacquered)	<b>L</b>	AL 2401 TSA D
classic brass	<b>P</b>	ME 2401 TSA C
antique brass		ME 2401 TSA AT

### Cover kit 2-gang

to clip on F 40 push-button modules 2-gang

ref.-no.: 4072 TSM, 4192 TSM, 4092 TSEM, 4072 RF TSM, 4224 TSM, 4008 TSM, FM 4002 M

#### Thermoplastic (breakproof) high-gloss

ivory	<b>L</b>	LS 402 TSA
white	<b>L</b>	LS 402 TSA WW
light grey	<b>L</b>	LS 402 TSA LG
black	<b>L</b>	LS 402 TSA SW

#### metal versions

aluminium	<b>P</b> <b>L</b>	AL 2402 TSA
stainless steel	<b>L</b>	ES 2402 TSA
anthracite (aluminium lacquered)	<b>L</b>	AL 2402 TSA AN
dark (aluminium lacquered)	<b>L</b>	AL 2402 TSA D
classic brass	<b>P</b>	ME 2402 TSA C
antique brass		ME 2402 TSA AT

### Cover kit 3-gang

to clip on F 40 push-button modules 3-gang

ref.-no.: 4073 TSM, 4193 TSM, 4093 TSEM, 4073 RF TSM, 4236 TSM, 4008 TSM, FM 4003 M

#### Thermoplastic (breakproof) high-gloss

ivory	<b>L</b>	LS 403 TSA
white	<b>L</b>	LS 403 TSA WW
light grey	<b>L</b>	LS 403 TSA LG
black	<b>L</b>	LS 403 TSA SW

#### metal versions

aluminium	<b>P</b> <b>L</b>	AL 2403 TSA
stainless steel	<b>L</b>	ES 2403 TSA
anthracite (aluminium lacquered)	<b>L</b>	AL 2403 TSA AN
dark (aluminium lacquered)	<b>L</b>	AL 2403 TSA D
classic brass	<b>P</b>	ME 2403 TSA C
antique brass		ME 2403 TSA AT

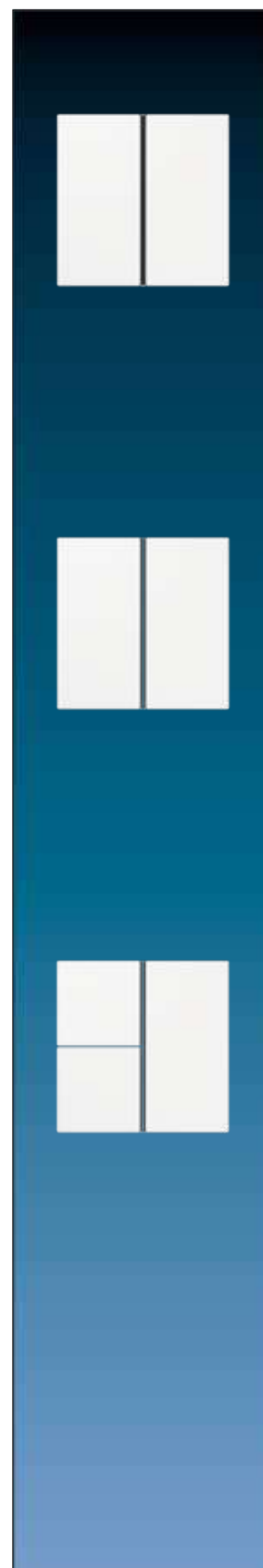

**P** Colour printing possible

**L** Laser labelling possible



Ref.-no.

#### Cover kits for LS range

##### Cover kit 4-gang

to clip on F 40 push-button modules 4-gang

ref.-no.: 4074 TSM, 4194 TSM, 4094 TSEM, 4074 RF TSM, 4248 TSM, 4008 TSM, FM 4004 M

##### Thermoplastic (breakproof) high-gloss

ivory	<b>L</b>	<b>LS 404 TSA</b>
white	<b>L</b>	<b>LS 404 TSA WW</b>
light grey	<b>L</b>	<b>LS 404 TSA LG</b>
black	<b>L</b>	<b>LS 404 TSA SW</b>

##### metal versions

aluminium	<b>P</b> <b>L</b>	<b>AL 2404 TSA</b>
stainless steel	<b>L</b>	<b>ES 2404 TSA</b>
anthracite (aluminium lacquered)	<b>L</b>	<b>AL 2404 TSA AN</b>
dark (aluminium lacquered)	<b>L</b>	<b>AL 2404 TSA D</b>
classic brass	<b>P</b>	<b>ME 2404 TSA C</b>
antique brass		<b>ME 2404 TSA AT</b>

**Professional laser inscription and colour printing!**

**For further information see [www.jung.de/gt](http://www.jung.de/gt)**

#### Covers with symbols for LS range

##### Cover 1-gang

**with symbols ▲▼**

to clip on F 40 push-button modules 1-gang

ref.-no.: 4071 TSM, 4191 TSM, 4091 TSEM, 4071 RF TSM, 4212 TSM, 4008 TSM, FM 4001 M

##### Thermoplastic (breakproof) high-gloss

ivory	<b>LS 401 TSAP</b>
white	<b>LS 401 TSAP WW</b>
light grey	<b>LS 401 TSAP LG</b>
black	<b>LS 401 TSAP SW</b>

##### metal versions

aluminium	<b>AL 2401 TSAP</b>
stainless steel	<b>ES 2401 TSAP</b>
anthracite (aluminium lacquered)	<b>AL 2401 TSAP AN</b>
dark (aluminium lacquered)	<b>AL 2401 TSAP D</b>

##### Cover 2-gang

**with symbols ▲▼**

to exchange the covers of the cover kit 2-gang ref.-no.: ..402 TSA..

and the right cover of the cover kit 3-gang ref.-no.: ..403 TSA.. in the LS range

##### Thermoplastic (breakproof) high-gloss

ivory	<b>LS 402 TSAP</b>
white	<b>LS 402 TSAP WW</b>
light grey	<b>LS 402 TSAP LG</b>
black	<b>LS 402 TSAP SW</b>

##### metal versions

aluminium	<b>AL 2402 TSAP</b>
stainless steel	<b>ES 2402 TSAP</b>
anthracite (aluminium lacquered)	<b>AL 2402 TSAP AN</b>
dark (aluminium lacquered)	<b>AL 2402 TSAP D</b>
classic brass	<b>ME 2402 TSAP C</b>
antique brass	<b>ME 2402 TSAP AT</b>

Delivery of cover kits:  
1 complete set per ref.-no.!

	Ref.-no.
<b>Covers with symbols for LS range</b>	
<b>Cover 4-gang with symbols ▲▼</b>	
to exchange the top left cover of the cover kit 3-gang ref.-no.: ..403 TSA.. and top left and bottom right cover of the cover kit 4-gang ref.-no.: ..404 TSA.. in the LS range	
<b>Thermoplastic (breakproof) high-gloss</b>	
ivory	LS 404 TSAP 14
white	LS 404 TSAP WW 14
light grey	LS 404 TSAP LG 14
black	LS 404 TSAP SW 14
<b>metal versions</b>	
aluminium	AL 2404 TSAP 14
stainless steel	ES 2404 TSAP 14
anthracite (aluminium lacquered)	AL 2404 TSAP AN 14
dark (aluminium lacquered)	AL 2404 TSAP D 14
classic brass	ME 2404 TSAP C 14
antique brass	ME 2404 TSAP AT 14
<b>Cover 4-gang with symbols ▲▼</b>	
to exchange the bottom left cover of the cover kit 3-gang ref.-no.: ..403 TSA.. and top right and bottom left cover of the cover kit 4-gang ref.-no.: ..404 TSA.. in the LS range	
<b>Thermoplastic (breakproof) high-gloss</b>	
ivory	LS 404 TSAP 23
white	LS 404 TSAP WW 23
light grey	LS 404 TSAP LG 23
black	LS 404 TSAP SW 23
<b>metal versions</b>	
aluminium	AL 2404 TSAP 23
stainless steel	ES 2404 TSAP 23
anthracite (aluminium lacquered)	AL 2404 TSAP AN 23
dark (aluminium lacquered)	AL 2404 TSAP D 23
classic brass	ME 2404 TSAP C 23
antique brass	ME 2404 TSAP AT 23
<b>Adapter frame</b>	
(Spare part) to combine push-button modules with LS range Also included in delivery of modules.	
	LS 4 AR



# Room controller F 40



KNX OLED ROOM CONTROLLER



**KNX ROOM CONTROLLER DISPLAY COMPACT MODULE**

With three control panels for switching, dimming or blind control the preset functions are executed using the markings on the left and right on the display; the buttons can be freely parametrised.

**KNX OLED ROOM CONTROLLER**

This room controller has a high resolution OLED graphical display with brilliant presentation including plain text display. The large buttons are used for the operation.

The room functions and scenes are controlled with the room controllers of the F 40 family using the large operating buttons. Status and function selection are shown on the graphical display. Centrally arranged, coloured LEDs for operation and status display round off the easy handling.

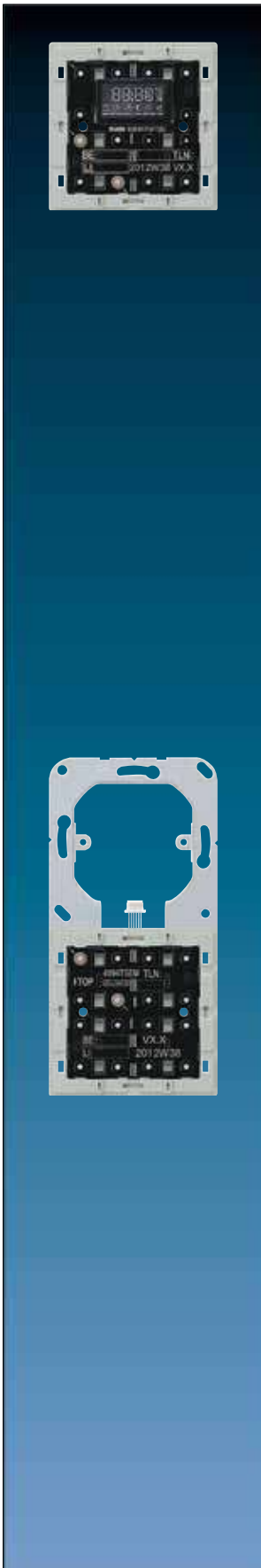

Ref.-no.

**Room controller display compact module**

can be extended by means of a push-button extension module, ref.-no.: 409.. TSEM  
 Adapter frames are included in delivery: ref.-no. LS 4 AR for LS range (pre-mounted)  
 and ref.-no. CD 4 AR for CD range. AS / A ranges without adapter frame.

**4093 KRM TS D**

recommended mounting height: 1.5 m

**Intended use**

- Measurement and feedback control of the room temperature
- Operation of loads, e.g. light on/off, dimming, blinds up/down, brightness values, temperatures, calling up and saving light scenes, etc.
- Installation in wall box according to DIN 49073

**Product characteristics**

All buttons can be assigned with functions for controller operation.

- Four red status LEDs
- A blue operation LED as an orientation light and to indicate the programming status
- Integrated bus coupling unit
- Connection of push-button extension module
- Integrated room temperature sensor
- Room temperature control with setpoint value specification
- Display of room or set temperature
- Display of outdoor temperature – with external sensor, e.g. weather station
- Display of time, in conjunction with KNX time encoder
- Push-button functions for switching, dimming, blinds control, valuator, light scenes, etc.
- Push-button function or rockers function, vertical or horizontal
- Fan coil application with up to 8 fan speeds and auto function
- Transparent cover kit (included) for temporary site use without design covers

**Push-button extension module**

for the extension of up to 4 additional push-buttons for the devices:

- Universal push-button module (ref.-no. 419.. TSM)
- Room controller display compact module (ref.-no. 4093 KRM TS D)
- Room controller display module 2-gang (ref.-no. RCD .. 4092 M)
- Smart Control KNX (ref.-no. SC 1000 KNX)

preferred installation: vertical

Adapter frames are included in delivery: ref.-no. LS 4 AR for LS range (pre-mounted)  
 and ref.-no. CD 4 AR for CD range. AS / A ranges without adapter frame.

red LED: status indication

1-gang	<b>4091 TSEM</b>
2-gang	<b>4092 TSEM</b>
3-gang	<b>4093 TSEM</b>
4-gang	<b>4094 TSEM</b>

- P** Colour printing possible
- L** Laser labelling possible

Delivery of cover kits:  
1 complete set per ref.-no.!

Ref.-no.

**Cover kits for AS and A ranges****Cover kit**

to clip on room controller display compact module ref.-no.: 4093 KRM TS D

**Thermoplastic (breakproof) high-gloss**

ivory	<b>L</b>	<b>A 4093 TSA</b>
white	<b>L</b>	<b>A 4093 TSA WW</b>
black	<b>L</b>	<b>A 4093 TSA SW</b>

**Thermoplastic (breakproof) lacquered**

aluminium	<b>P</b> <b>L</b>	<b>A 4093 TSA AL</b>
champagne	<b>P</b>	<b>A 4093 TSA CH</b>
mocha		<b>A 4093 TSA MO</b>
matt anthracite	<b>L</b>	<b>A 4093 TSA ANM</b>

**Professional laser inscription and colour printing!**  
**For further information see [www.jung.de/gt](http://www.jung.de/gt)**

**Cover with temperature symbol**

to exchange the display cover of the cover kit ref.-no.: A 4093 TSA..

**Thermoplastic (breakproof) high-gloss**

A 409 T

**Cover 4-gang****with symbols ▲▼**

to exchange the bottom right cover of the cover kit ref.-no.: A 4093 TSA..

**Thermoplastic (breakproof) high-gloss**

ivory	<b>A 404 TSAP 14</b>
white	<b>A 404 TSAP WW 14</b>
black	<b>A 404 TSAP SW 14</b>

**Thermoplastic (breakproof) lacquered**

aluminium	<b>A 404 TSAP AL 14</b>
champagne	<b>A 404 TSAP CH 14</b>
mocha	<b>A 404 TSAP MO 14</b>
matt anthracite	<b>A 404 TSAP ANM 14</b>

**Cover 4-gang****with symbols ▲▼**

to exchange the bottom left cover of the cover kit ref.-no.: A 4093 TSA..

**Thermoplastic (breakproof) high-gloss**

ivory	<b>A 404 TSAP 23</b>
white	<b>A 404 TSAP WW 23</b>
black	<b>A 404 TSAP SW 23</b>

**Thermoplastic (breakproof) lacquered**

aluminium	<b>A 404 TSAP AL 23</b>
champagne	<b>A 404 TSAP CH 23</b>
mocha	<b>A 404 TSAP MO 23</b>
matt anthracite	<b>A 404 TSAP ANM 23</b>

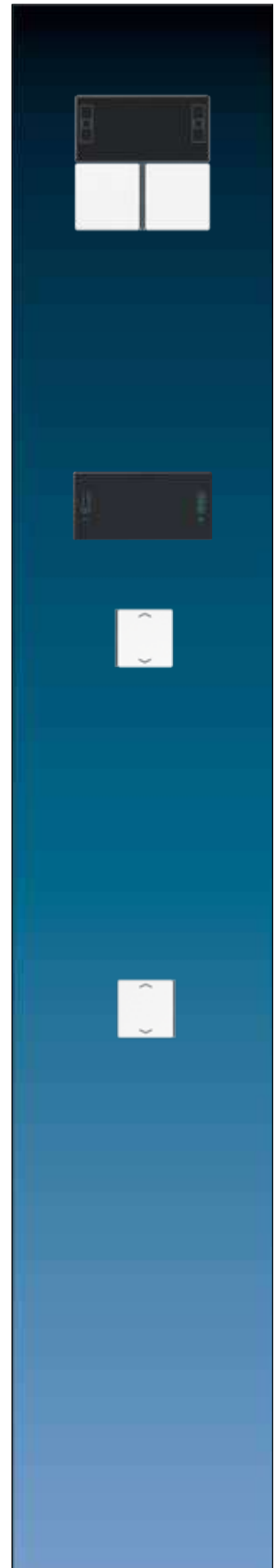

Delivery of cover kits:  
1 complete set per ref.-no.!

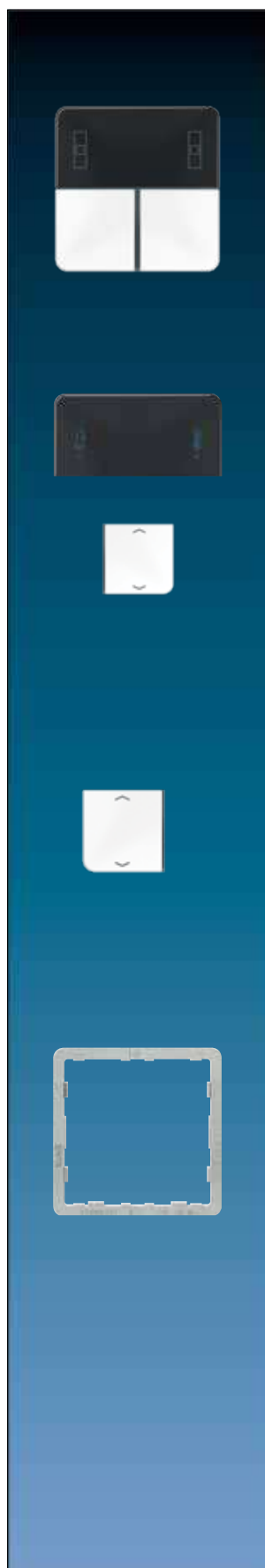

---

 Ref.-no.
 





---

### Cover kits for CD range

#### Cover kit

to clip on room controller display compact module ref.-no.: 4093 KRM TS D

#### Thermoplastic (breakproof) high-gloss

ivory	 <b>CD 4093 TSA</b>
white	 <b>CD 4093 TSA WW</b>
grey	 <b>CD 4093 TSA GR</b>
light grey	 <b>CD 4093 TSA LG</b>
black	 <b>CD 4093 TSA SW</b>

#### Professional laser inscription and colour printing!

For further information see [www.jung.de/gt](http://www.jung.de/gt)

#### Cover with temperature symbol

to exchange the display cover of the cover kit ref.-no.: CD 4093 TSA..

#### Thermoplastic (breakproof) high-gloss

---

 CD 409 T
 

---

#### Cover 4-gang

##### with symbols ▲▼

to exchange the bottom right cover of the cover kit ref.-no.: CD 4093 TSA..

#### Thermoplastic (breakproof) high-gloss

ivory	<b>CD 404 TSAP 14</b>
white	<b>CD 404 TSAP WW 14</b>
grey	<b>CD 404 TSAP GR 14</b>
light grey	<b>CD 404 TSAP LG 14</b>
black	<b>CD 404 TSAP SW 14</b>

#### Cover 4-gang

##### with symbols ▲▼

to exchange the bottom left cover of the cover kit ref.-no.: CD 4093 TSA..

#### Thermoplastic (breakproof) high-gloss

ivory	<b>CD 404 TSAP 23</b>
white	<b>CD 404 TSAP WW 23</b>
grey	<b>CD 404 TSAP GR 23</b>
light grey	<b>CD 404 TSAP LG 23</b>
black	<b>CD 404 TSAP SW 23</b>

#### Adapter frame

(Spare part)

to combine push-button modules with CD range

Also included in delivery of modules.

---

 CD 4 AR
 

---

**P** Colour printing possible

**L** Laser labelling possible

Ref.-no.

### Cover kits for LS range

#### Cover kit

to clip on room controller display compact module ref.-no.: 4093 KRM TS D

#### Thermoplastic (breakproof) high-gloss

ivory	<b>L</b>	<b>LS 4093 TSA</b>
white	<b>L</b>	<b>LS 4093 TSA WW</b>
light grey	<b>L</b>	<b>LS 4093 TSA LG</b>
black	<b>L</b>	<b>LS 4093 TSA SW</b>

#### metal versions

aluminium	<b>P</b> <b>L</b>	<b>AL 4093 TSA</b>
stainless steel	<b>L</b>	<b>ES 4093 TSA</b>
anthracite (aluminium lacquered)	<b>L</b>	<b>AL 4093 TSA AN</b>
dark (aluminium lacquered)	<b>L</b>	<b>AL 4093 TSA D</b>
classic brass	<b>P</b>	<b>ME 4093 TSA C</b>
antique brass		<b>ME 4093 TSA AT</b>

#### Professional laser inscription and colour printing!

For further information see [www.jung.de/gt](http://www.jung.de/gt)

#### Cover with temperature symbol

to exchange the display cover of the cover kit ref.-no.: .. 4093 TSA .. in the LS range

#### Thermoplastic (breakproof) high-gloss

LS 409 T

#### Cover 4-gang

#### with symbols ▲▼

to exchange the bottom right cover of the cover kit ref.-no.: .. 4093 TSA .. in the LS range

#### Thermoplastic (breakproof) high-gloss

ivory	<b>LS 404 TSAP 14</b>
white	<b>LS 404 TSAP WW 14</b>
light grey	<b>LS 404 TSAP LG 14</b>
black	<b>LS 404 TSAP SW 14</b>

#### metal versions

aluminium	<b>AL 2404 TSAP 14</b>
stainless steel	<b>ES 2404 TSAP 14</b>
anthracite (aluminium lacquered)	<b>AL 2404 TSAP AN 14</b>
dark (aluminium lacquered)	<b>AL 2404 TSAP D 14</b>
classic brass	<b>ME 2404 TSAP C 14</b>
antique brass	<b>ME 2404 TSAP AT 14</b>

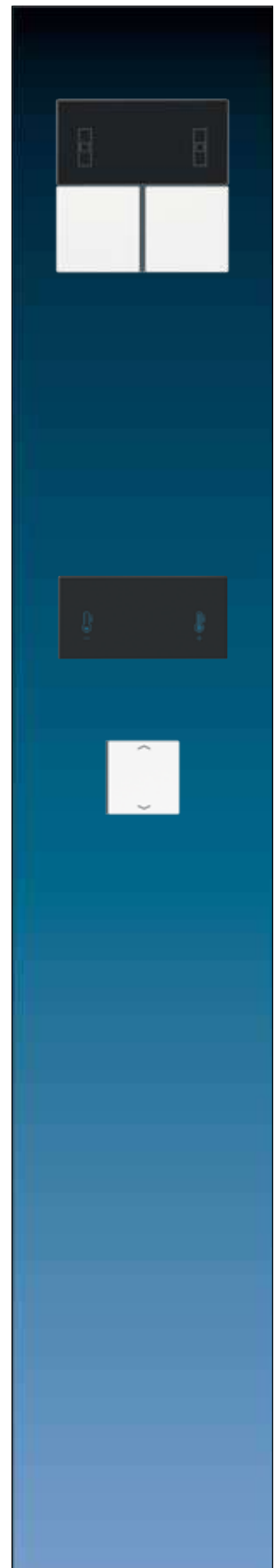



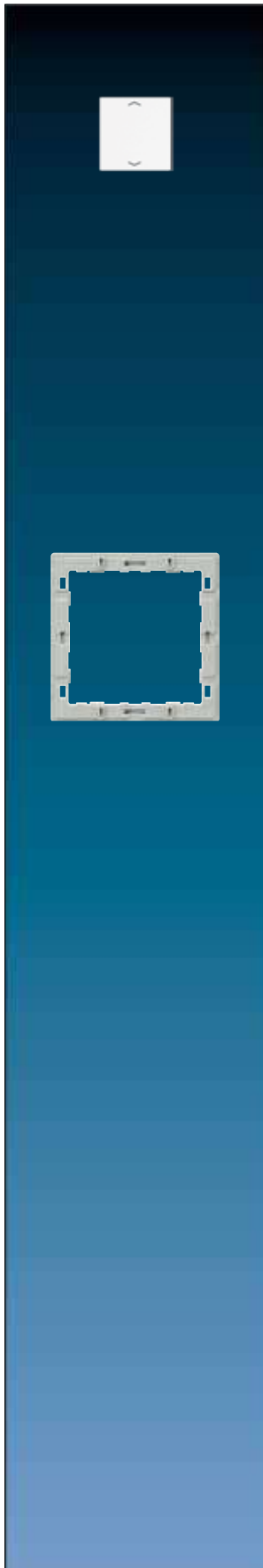

Ref.-no.

**Cover kits for LS range****Cover 4-gang  
with symbols ▲▼**

to exchange the bottom left cover of the cover kit ref.-no.: .. 4093 TSA .. in the LS range

**Thermoplastic (breakproof) high-gloss**

ivory	<b>LS 404 TSAP 23</b>
white	<b>LS 404 TSAP WW 23</b>
light grey	<b>LS 404 TSAP LG 23</b>
black	<b>LS 404 TSAP SW 23</b>

**metal versions**

aluminium	<b>AL 2404 TSAP 23</b>
stainless steel	<b>ES 2404 TSAP 23</b>
anthracite (aluminium lacquered)	<b>AL 2404 TSAP AN 23</b>
dark (aluminium lacquered)	<b>AL 2404 TSAP D 23</b>
classic brass	<b>ME 2404 TSAP C 23</b>
antique brass	<b>ME 2404 TSAP AT 23</b>

**Adapter frame**

(Spare part)

to combine push-button modules with LS range

Also included in delivery of modules.

**LS 4 AR**

	Ref.-no.
<b>Room controller display module 2-gang</b> can be extended by means of a push-button extension module, ref.-no.: 409.. TSEM <b>for CD range</b>	<b>RCD CD 4092 M</b>
<b>for LS range</b>	<b>RCD LS 4092 M</b>

recommended mounting height: 1.5 m

### Intended use

- Operation of consumers, e.g. lights on/off, dimming, blinds/shutters up/down, brightness values, temperatures, storing and recalling of light scenes etc.
- Room temperature control
- Installation in mounting box according to DIN 49073

### Product characteristics

- Push-button functions for switching, dimming, blinds control, valuator, light scenes, etc.
- Vertical and horizontal key/rocker functions
- Two red LEDs per control key as status or operation indicators
- Display of values and texts
- Running text display for one or two messages with max. 14 characters
- Integrated room temperature sensor
- Room temperature control with setpoint value preset
- Display of room temperature and setpoint temperature
- Indication of outside temperature (only with external sensor)
- Integrated bus coupling unit
- In combination with Facility Pilot "Multi-Room Control": music play control, display of music titles, artists, etc.
- Display unit for the KNX central alarm unit
- Fan coil application with up to 8 fan speeds and auto function
- OLED graphic display with high resolution
- High contrast
- Viewing angle 170° from each direction
- Transparent cover kit (included) for temporary site use without design covers
- Connection for a push-button extension module, 1-4 gang

### Push-button extension module

for the extension of up to 4 additional push-buttons for the devices:

- Universal push-button module (ref.-no. 419.. TSM)
- Room controller display compact module (ref.-no. 4093 KRM TS D)
- Room controller display module 2-gang (ref.-no. RCD .. 4092 M)
- Smart Control KNX (ref.-no. SC 1000 KNX)

preferred installation: vertical

Adapter frames are included in delivery: ref.-no. LS 4 AR for LS range (pre-mounted)

and ref.-no. CD 4 AR for CD range. AS / A ranges without adapter frame.

red LED: status indication

1-gang	<b>4091 TSEM</b>
2-gang	<b>4092 TSEM</b>
3-gang	<b>4093 TSEM</b>
4-gang	<b>4094 TSEM</b>



 Colour printing possible

 Laser labelling possible

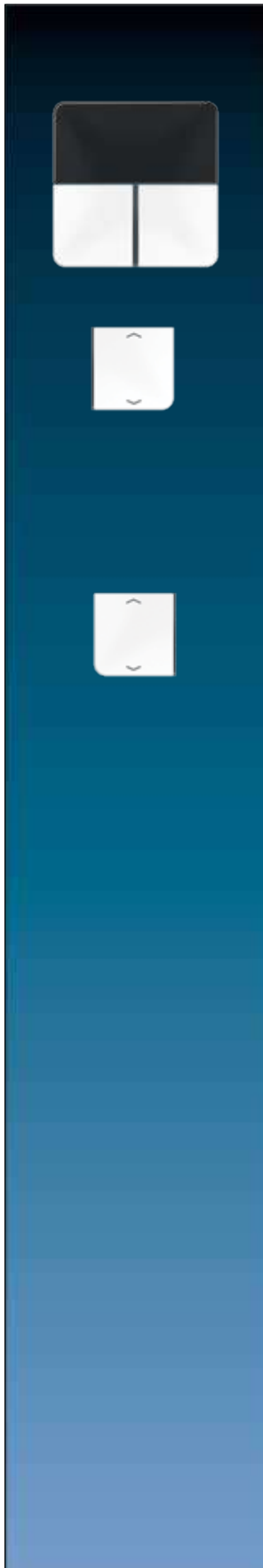





Ref.-no.

#### Cover kits for CD range

##### Cover kit

to clip on room controller display module 2-gang ref.-no.: RCD CD 4092 M

##### Thermoplastic (breakproof) high-gloss

ivory	 RCD CD 4092 TSA
white	 RCD CD 4092 TSA WW
grey	 RCD CD 4092 TSA GR
light grey	 RCD CD 4092 TSA LG
black	 RCD CD 4092 TSA SW

##### Cover 4-gang

##### with symbols ▲▼

to exchange the bottom right cover of the cover kit ref.-no.: RCD CD 4092 TSA ..

##### Thermoplastic (breakproof) high-gloss

ivory	CD 404 TSAP 14
white	CD 404 TSAP WW 14
grey	CD 404 TSAP GR 14
light grey	CD 404 TSAP LG 14
black	CD 404 TSAP SW 14

##### Cover 4-gang

##### with symbols ▲▼

to exchange the bottom left cover of the cover kit ref.-no.: RCD CD 4092 TSA ..

##### Thermoplastic (breakproof) high-gloss

ivory	CD 404 TSAP 23
white	CD 404 TSAP WW 23
grey	CD 404 TSAP GR 23
light grey	CD 404 TSAP LG 23
black	CD 404 TSAP SW 23

Professional inscription see [www.jung.de/gt](http://www.jung.de/gt)





Delivery of cover kits:  
1 complete set per ref.-no.!

Ref.-no.







**Cover kits for CD range****Cover kit**

to clip on room controller display module 2-gang ref.-no.: RCD LS 4092 M

**Thermoplastic (breakproof) high-gloss**

ivory	 RCD LS 4092 TSA
white	 RCD LS 4092 TSA WW
light grey	 RCD LS 4092 TSA LG
black	 RCD LS 4092 TSA SW

**metal versions**

aluminium	  RCD AL 4092 TSA
stainless steel	 RCD ES 4092 TSA
anthracite (aluminium lacquered)	 RCD AL 4092 TSA AN
dark (aluminium lacquered)	 RCD AL 4092 TSA D
classic brass	 RCD ME 4092 TSA C
antique brass	RCD ME 4092 TSA AT

**Cover 4-gang****with symbols ▲▼**

to exchange the bottom right cover of the cover kit ref.-no.: RCD .. 4092 TSA .. in the LS range

**Thermoplastic (breakproof) high-gloss**

ivory	LS 404 TSAP 14
white	LS 404 TSAP WW 14
light grey	LS 404 TSAP LG 14
black	LS 404 TSAP SW 14

**metal versions**

aluminium	AL 2404 TSAP 14
stainless steel	ES 2404 TSAP 14
anthracite (aluminium lacquered)	AL 2404 TSAP AN 14
dark (aluminium lacquered)	AL 2404 TSAP D 14
classic brass	ME 2404 TSAP C 14
antique brass	ME 2404 TSAP AT 14

**Cover 4-gang****with symbols ▲▼**

to exchange the bottom left cover of the cover kit ref.-no.: RCD .. 4092 TSA .. in the LS range

**Thermoplastic (breakproof) high-gloss**

ivory	LS 404 TSAP 23
white	LS 404 TSAP WW 23
light grey	LS 404 TSAP LG 23
black	LS 404 TSAP SW 23

**metal versions**

aluminium	AL 2404 TSAP 23
stainless steel	ES 2404 TSAP 23
anthracite (aluminium lacquered)	AL 2404 TSAP AN 23
dark (aluminium lacquered)	AL 2404 TSAP D 23
classic brass	ME 2404 TSAP C 23
antique brass	ME 2404 TSAP AT 23

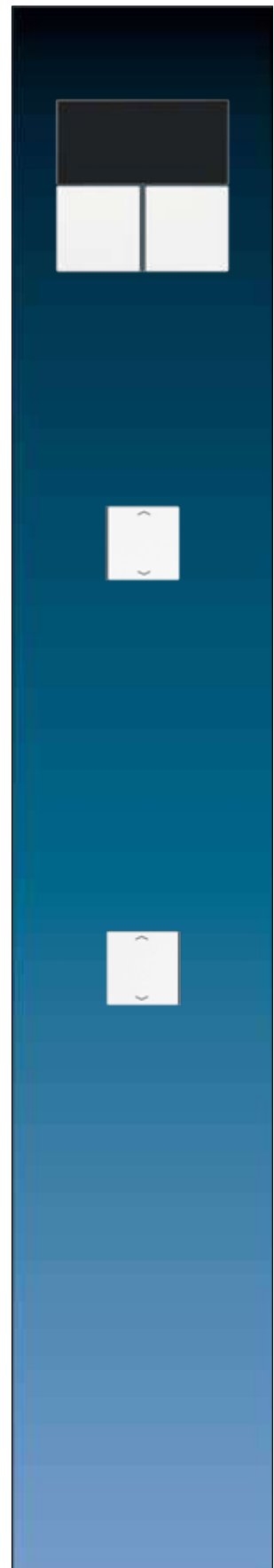

# KNX RF

## KNX RF RADIO CONVERTER



Interface between KNX RF and KNX TP

## KNX RF RADIO HAND-HELD TRANSMITTER



2-gang and 4-gang version

## KNX RF RADIO WALL TRANSMITTER



Operating philosophy F 40

## KNX RF RADIO WALL TRANSMITTER



Operating philosophy F 50

The KNX radio standard in the JUNG design: the radio wall transmitter in the F 50 and F 40 families is ideal for retrofitting and upgrading existing KNX systems. The KNX radio wall transmitter is perfectly suited for structural conditions where bus lines cannot or should not be installed. This allows the particularly flat devices to be flexibly placed in the room, as they are simply glued on - be it plaster, wood or glass. The room functions can be

conveniently controlled by a simple touch of a button. KNX hand-held transmitters are available as an alternative to the wall transmitters. Addressing, parameterization and diagnostics are carried out via the KNX radio USB stick or alternatively via the KNX data interface. The bidirectional connection of KNX RF and wired KNX TP takes place via JUNG radio converter.





**KNX RF RADIO WALL TRANSMITTER F 40**

Ref.-no.

**KNX RF radio transmitter modules F 50****Intended use**

- Radio operation of loads, e.g. light on/off, dimming, Venetian blinds up/down, brightness values, calling up and saving light scenes
- Operation in cabled KNX systems via radio converter (ref.-no.: MK 100 RF)
- Mounting on appliance box according to DIN 49073, screw fixing on walls or adhesive fixing on smooth, even surfaces (glass)

**Product characteristics**

- Push-button functions for switching, dimming, blinds control, valuator, light scenes, etc.
- Button pairs for push-button function or rocker function
- Status indication with LED
- Integrated temperature sensor
- Battery-powered device (battery compartment accessible from front)

**Technical data**

Rated voltage:	DC 3 V
Battery type:	1 x lithium CR 2450 (included)
Ambient temperature:	-5 ... +45 °C
Radio frequency:	868.0 ... 868.6 MHz
Transmitting power:	max. 20 mW
Transmission range in free field:	typical 100 m

**for AS and A ranges****KNX RF radio transmitter module 1-gang**

including transparent cover ref.-no.: A 50 NA  
 for cover kit 1-gang, complete, ref.-no.: A 501 TSA ..  
 Project design and commissioning with ETS5 or a more recent version.  
 ETS product family: Push-button  
 Product type: 1-gang push-button  
 1 green LED: actuator status  
 1 red LED: transmission status

**A 5071 RF TSM****KNX RF radio transmitter module 2-gang**

including transparent cover ref.-no.: A 50 NA  
 for cover kit 2-gang, complete, ref.-no.: A 502 TSA ..  
 Project design and commissioning with ETS5 or a more recent version.  
 ETS product family: Push-button  
 Product type: 2-gang push-button  
 2 green LED: actuator status  
 1 red LED: transmission status

**A 5072 RF TSM****KNX RF radio transmitter module 3-gang**

including transparent cover ref.-no.: A 50 NA  
 for cover kit 3-gang, complete, ref.-no.: A 503 TSA ..  
 Project design and commissioning with ETS5 or a more recent version.  
 ETS product family: Push-button  
 Product type: 3-gang push-button  
 3 green LED: actuator status  
 1 red LED: transmission status

**A 5073 RF TSM**

Ref.-no.

**KNX RF radio transmitter module 4-gang**

including transparent cover ref.-no.: A 50 NA  
 for cover kit 4-gang, complete, ref.-no.: A 504 TSA ..  
 Project design and commissioning with ETS5 or a more recent version.  
 ETS product family: Push-button  
 Product type: 4-gang push-button  
 4 green LED: actuator status  
 1 red LED: transmission status

**A 5074 RF TSM**

Cover kits for the A range see page 36 and 37

**KNX RF radio transmitter modules F 50  
for CD range****KNX RF radio transmitter module 1-gang**

including transparent cover ref.-no.: CD 50 NA  
 for cover kit 1-gang, complete, ref.-no.: CD 501 TSA ..  
 Project design and commissioning with ETS5 or a more recent version.  
 ETS product family: Push-button  
 Product type: 1-gang push-button  
 1 green LED: actuator status  
 1 red LED: transmission status

**CD 5071 RF TSM****KNX RF radio transmitter module 2-gang**

including transparent cover ref.-no.: CD 50 NA  
 for cover kit 2-gang, complete, ref.-no.: CD 502 TSA ..  
 Project design and commissioning with ETS5 or a more recent version.  
 ETS product family: Push-button  
 Product type: 2-gang push-button  
 2 green LED: actuator status  
 1 red LED: transmission status

**CD 5072 RF TSM****KNX RF radio transmitter module 3-gang**

including transparent cover ref.-no.: CD 50 NA  
 for cover kit 3-gang, complete, ref.-no.: CD 503 TSA ..  
 Project design and commissioning with ETS5 or a more recent version.  
 ETS product family: Push-button  
 Product type: 3-gang push-button  
 3 green LED: actuator status  
 1 red LED: transmission status

**CD 5073 RF TSM****KNX RF radio transmitter module 4-gang**

including transparent cover ref.-no.: CD 50 NA  
 for cover kit 4-gang, complete, ref.-no.: CD 504 TSA ..  
 Project design and commissioning with ETS5 or a more recent version.  
 ETS product family: Push-button  
 Product type: 4-gang push-button  
 4 green LED: actuator status  
 1 red LED: transmission status

**CD 5074 RF TSM**

Cover kits for the CD range see page 42



Ref.-no.

**KNX RF radio transmitter modules F 50****for LS range****KNX RF radio transmitter module 1-gang**

including transparent cover ref.-no.: LS 50 NA  
 for cover kit 1-gang, complete, ref.-no.: ..501 TSA .. in the LS range  
 Can not be combined with frames in Flat Design.  
 Project design and commissioning with ETS5 or a more recent version.  
 ETS product family: Push-button  
 Product type: 1-gang push-button  
 1 green LED: actuator status  
 1 red LED: transmission status

**LS 5071 RF TSM****KNX RF radio transmitter module 2-gang**

including transparent cover ref.-no.: LS 50 NA  
 for cover kit 2-gang, complete, ref.-no.: ..502 TSA .. in the LS range  
 Can not be combined with frames in Flat Design.  
 Project design and commissioning with ETS5 or a more recent version.  
 ETS product family: Push-button  
 Product type: 2-gang push-button  
 2 green LED: actuator status  
 1 red LED: transmission status

**LS 5072 RF TSM****KNX RF radio transmitter module 3-gang**

including transparent cover ref.-no.: LS 50 NA  
 for cover kit 3-gang, complete, ref.-no.: ..503 TSA .. in the LS range  
 Can not be combined with frames in Flat Design.  
 Project design and commissioning with ETS5 or a more recent version.  
 ETS product family: Push-button  
 Product type: 3-gang push-button  
 3 green LED: actuator status  
 1 red LED: transmission status

**LS 5073 RF TSM****KNX RF radio transmitter module 4-gang**

including transparent cover ref.-no.: LS 50 NA  
 for cover kit 4-gang, complete, ref.-no.: ..504 TSA .. in the LS range  
 Can not be combined with frames in Flat Design.  
 Project design and commissioning with ETS5 or a more recent version.  
 ETS product family: Push-button  
 Product type: 4-gang push-button  
 4 green LED: actuator status  
 1 red LED: transmission status

**LS 5074 RF TSM**

Cover kits for the LS range see page 48 and 49

Ref.-no.

**KNX RF radio transmitter modules F 40**

Adapter frames are included in delivery: ref.-no. LS 4 AR for LS range (pre-mounted) and ref.-no. CD 4 AR for CD range. AS / A ranges without adapter frame.  
Project design and commissioning with ETS5 or a more recent version.

**Intended use**

- Radio operation of loads, e.g. light on/off, dimming, Venetian blinds up/down, brightness values, calling up and saving light scenes
- Operation in cabled KNX systems via radio converter (ref.-no.: MK 100 RF)
- Mounting on appliance box according to DIN 49073, screw fixing on walls or adhesive fixing on smooth, even surfaces (glass)

**Product characteristics**

- Push-button functions for switching, dimming, blinds control, valuator, light scenes, etc.
- Button pairs for push-button function or rocker function
- Status indication with LED
- Battery-powered device

**Technical data**

Rated voltage:	DC 3 V
Battery type:	1 x lithium CR 2450N (included)
Ambient temperature:	-5 ... +45 °C
Radio frequency:	868.0 ... 868.6 MHz
Transmitting power:	max. 20 mW
Transmission range in free field:	typical 100 m

**KNX RF radio transmitter module 1-gang**

for cover kit 1-gang, complete, ref.-no.: .. 401 TSA ..

for cover 1-gang with symbols, ref.-no.: .. 401 TSAP ..

Can not be combined with frames in Flat Design.

ETS product family: Push-button

Product type: 1-gang push-button

1 red LED: actuator status

1 blue LED: transmission status

4071 RF TSM

**KNX RF radio transmitter module 2-gang**

for cover kit 2-gang, complete, ref.-no.: .. 402 TSA ..

for cover 2-gang with symbols, ref.-no.: .. 402 TSAP ..

Can not be combined with frames in Flat Design.

ETS product family: Push-button

Product type: 2-gang push-button

2 red LEDs: actuator status

1 blue LED: transmission status

4072 RF TSM

**KNX RF radio transmitter module 3-gang**

for cover kit 3-gang, complete, ref.-no.: .. 403 TSA ..

for cover 2-gang with symbols, ref.-no.: .. 402 TSAP ..

for cover 4-gang with symbols, ref.-no.: .. 404 TSAP ..

Can not be combined with frames in Flat Design.

ETS product family: Push-button

Product type: 3-gang push-button

3 red LEDs: actuator status

1 blue LED: transmission status

4073 RF TSM

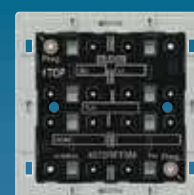
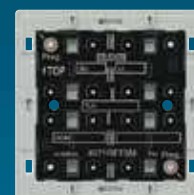





Ref.-no.

### KNX RF radio transmitter module 4-gang

for cover kit 4-gang, complete, ref.-no.: .. 404 TSA ..  
 for cover 4-gang with symbols, ref.-no.: .. 404 TSAP ..  
 Can not be combined with frames in Flat Design.  
 ETS product family: Push-button  
 Product type: 4-gang push-button  
 4 red LEDs: actuator status  
 1 blue LED: transmission status

**4074 RF TSM**

### KNX RF radio hand-held transmitter

Project design and commissioning with ETS5 or a more recent version.

#### Intended use

- Radio operation of loads, e.g. light on/off, dimming, Venetian blinds up/down, brightness values, calling up and saving light scenes
- Operation in cabled KNX systems via radio converter (ref.-no.: MK 100 RF)

#### Product characteristics

- Push-button functions for switching, dimming, blinds control, valuator, light scenes, etc.
- Button pairs for push-button function or rocker function
- Two-colour LED to display actuation, sending status and actuator feedback
- Battery-powered device

#### Technical data

Rated voltage:	DC 3 V
Battery type:	1 x lithium CR 2450N (included)
Ambient temperature:	-5 ... +45 °C
Relative humidity:	max. 80 % (no condensation)
Radio frequency:	868.0 ... 868.6 MHz
Transmitting power:	max. 20 mW
Transmission range in free field:	typical 100 m

### KNX RF radio hand-held transmitter

#### 2-gang

anthracite

**HS 2 RF**

### KNX RF radio hand-held transmitter

#### 4-gang

anthracite

**HS 4 RF**

Ref.-no.

**KNX RF radio USB stick****USB 2130 RF****Intended use**

- PC interface for the addressing, programming and diagnostics of KNX-RF devices
- USB stick for coupling to a PC with a Windows-based operating system

**Product characteristics**

- Commissioning, programming, visualisation and diagnostics of KNX-RF devices
- Automatic installation of PC communication via HID profile

**Technical data**

Rated voltage:	DC 5 V
USB version:	2.0
Connection USB:	type A
Ambient temperature:	-10 ... +70 °C
Relative humidity:	max. 80 % (no condensation)
Radio frequency:	868.0 ... 868.6 MHz
Transmitting power:	max. 20 mW
Transmission range in free field:	typical 100 m

**KNX RF radio converter**

Project design and commissioning with ETS5 or a more recent version.

**MK 100 RF****Intended use**

- Connection of KNX radio networks with cabled KNX lines
- Extension of the radio range in KNX radio networks (repeater operation, external power supply with 24 V AC/DC, e.g. ref.-no. NT 2415 REG VDC)
- Installation in wall box according to DIN 49073 with suitable cover





**KNX ROTARY SENSOR**  
LS 990 in chrome

# Rotary sensor

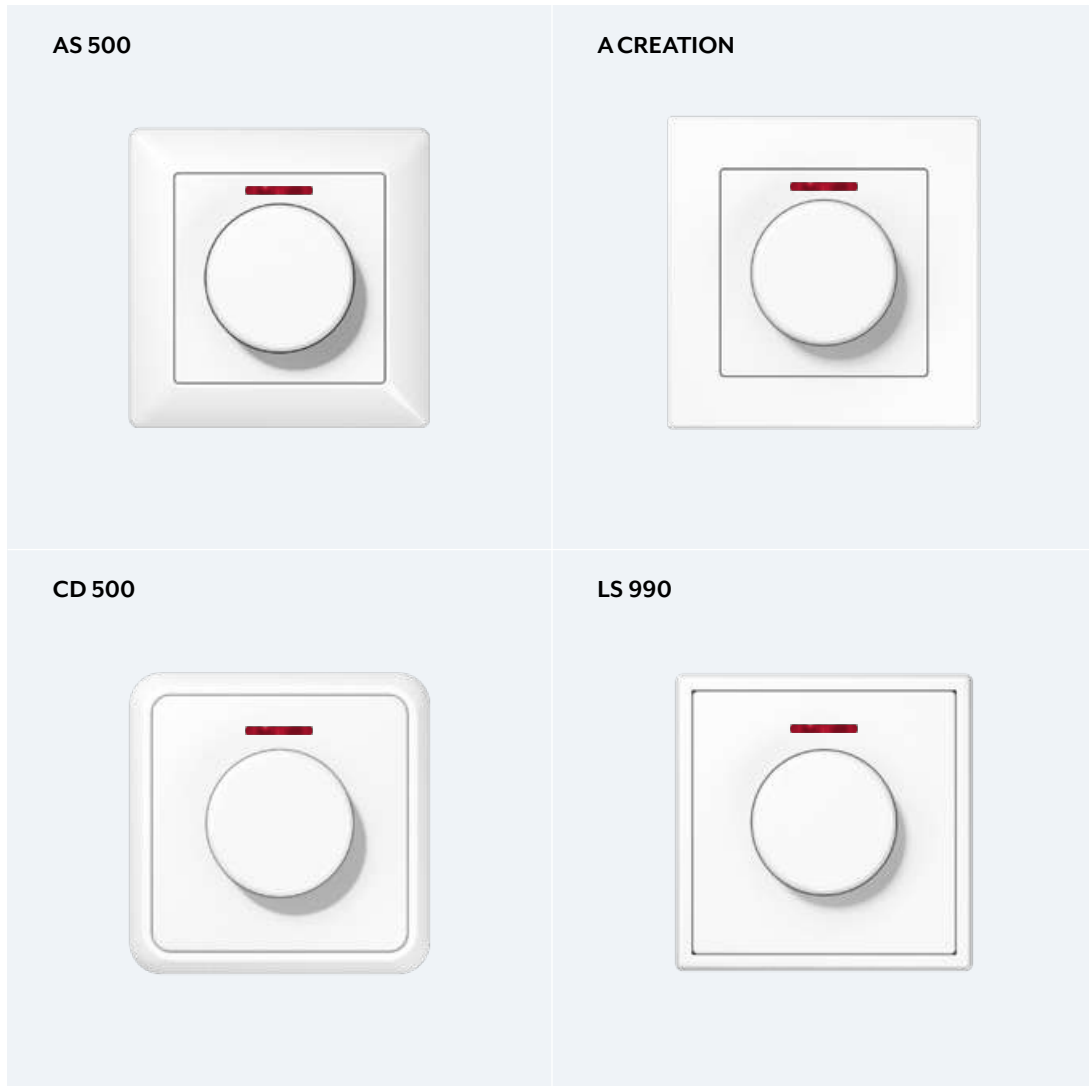

While the operation is also performed like a classic rotary dimmer, the functionality for the KNX rotary sensor is much more extensive. The room functions and scenes are controlled here according to the proven „turn and press“ principle. It also harmonises perfectly with the rest of the components in the JUNG design.

# Intuitive operating concept

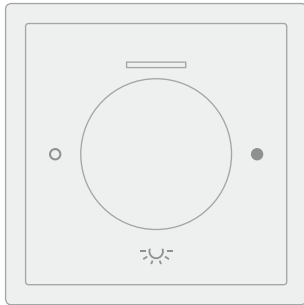

Lighting control

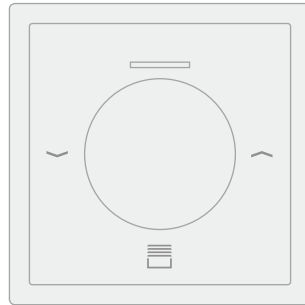

Blind control



Music control

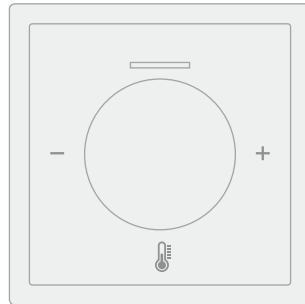

Temperature / climate control

## FUNCTIONALITY

The KNX rotary sensor is used for controlling dimming, switching, and blind actuators as well as for the setpoint shift of a temperature controller. It has two red status LEDs for orientation.

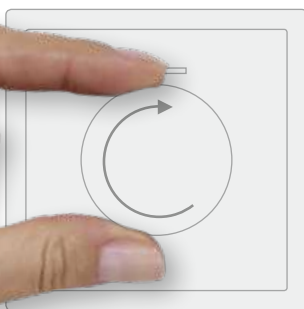

Turn



Press

## OPERATION

The rotary sensor is innovative because it implements an operating concept that has never before existed in this form in the KNX system. The well-known function of a rotary dimmer was used as template. The rotary sensor operates according to the same principle and also has

three extension inputs to connect conventional, floating contacts of switches, buttons and magnetic contacts. These combination possibilities extend the range of functions many times over. Labelling using the Graphic Tool further optimises the handling.





## Combination possibilities using satellites

One press of the button activates the programmed light scenario, that includes several lights in the living room, for example. All luminaires can be dimmed together using the KNX rotary sensor.



All three binary inputs of the rotary sensor are used here: Activate lighting scenes via the connected push-button, dim all connected luminaires together with the rotary sensor and also move the shutters up and down using the blind push-buttons.

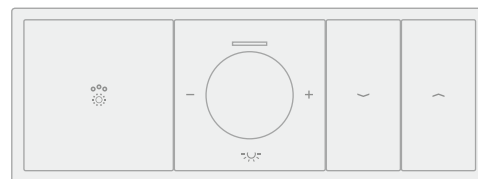

The Hi-Fi system is switched on and the volume controlled with the rotary sensor. The floor lamp is controlled in parallel using the serial button. The push-button connected to the third extension input functions as energy-saving button: Pressing this disconnects the current for the connected users and they do not drop into the energy-consuming standby mode.

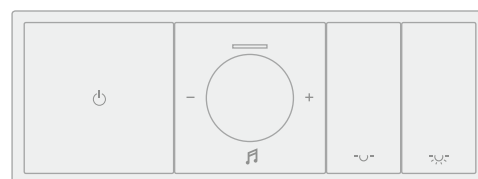



Ref.-no.

**Rotary sensor  
with integrated BCU  
with integrated push-button interface 3-gang  
with push-button function and acoustic signal**

Function: switching, dimming, shutter control, value transmitter, scene extension

**DS 4092 TS****Intended use**

- Operation of loads, e.g. light on/off, dimming, blinds up/down, brightness values, temperatures, calling up and saving light scenes, etc.
- Installation in wall box according to DIN 49073

**Product characteristics**

- Operation by turning or pressing the control button
- Integrated push-button interface: Three binary inputs for potential-free contacts
- Functions for control button and push-button interface: Switching, dimming, shutter control, value transmitters, calling up scenes, etc.
- Two red status LEDs
- Acoustic signal transmitter, e.g. for status, operation or alarm message, ringtone or audible alert
- Alarm function, optional with confirmation by pressing
- Convenience function for dimming and value adjustment: Preselection of the increment by fast turning
- Energy saving mode
- Separated locking functions for control button and push-button interface

**P** Colour printing possible

**L** Laser labelling possible

Ref.-no.

**Centre plate with knob and lens  
for rotary sensor ref.-no.: DS 4092 TS**

**for AS and A ranges**

**Duroplastic (scratch-proof) glossy**

ivory	<b>P</b>	A 1540 KO5
white	<b>P</b>	A 1540 KO5 WW
black		A 1540 KO5 SW

**Duroplastic lacquered**

aluminium	<b>P</b> <b>L</b>	A 1540 KO5 AL
champagne	<b>P</b>	A 1540 KO5 CH
mocha		A 1540 KO5 MO

**Thermoplastic (breakproof) high-gloss**

white	<b>L</b>	A 1540 BF KO5 WW
black	<b>L</b>	A 1540 BF KO5 SW

**Thermoplastic (breakproof) lacquered**

matt anthracite	<b>L</b>	A 1540 BF KO5 ANM
-----------------	----------	-------------------

**for CD range**

**Duroplastic (scratch-proof) glossy**

ivory	<b>P</b>	CD 1540 KO5
white	<b>P</b>	CD 1540 KO5 WW
grey		CD 1540 KO5 GR
light grey	<b>P</b>	CD 1540 KO5 LG
black		CD 1540 KO5 SW

**for LS range**

**Duroplastic (scratch-proof) glossy**

ivory	<b>P</b>	LS 1940 KO5
white	<b>P</b>	LS 1940 KO5 WW
light grey	<b>P</b>	LS 1940 KO5 LG
black		LS 1940 KO5 SW

**metal versions**

aluminium	<b>P</b> <b>L</b>	AL 1940 KO5
stainless steel	<b>L</b>	ES 1940 KO5
anthracite (aluminium lacquered)	<b>L</b>	AL 1940 KO5 AN
chrome		GCR 1940 KO5
gold-coloured		GO 1940 KO5
classic brass	<b>P</b>	ME 1940 KO5 C
antique brass		ME 1940 KO5 AT



## Push-button BCU

Operating KNX in conventional design: The push-buttons with integrated BCU (integrated bus coupling unit) are the same in design and handling as conventional buttons; however, they have the variety of functions of a smart KNX sensor.



**PUSH-BUTTON BCU**  
LS 990 in aluminium



## Variety of designs

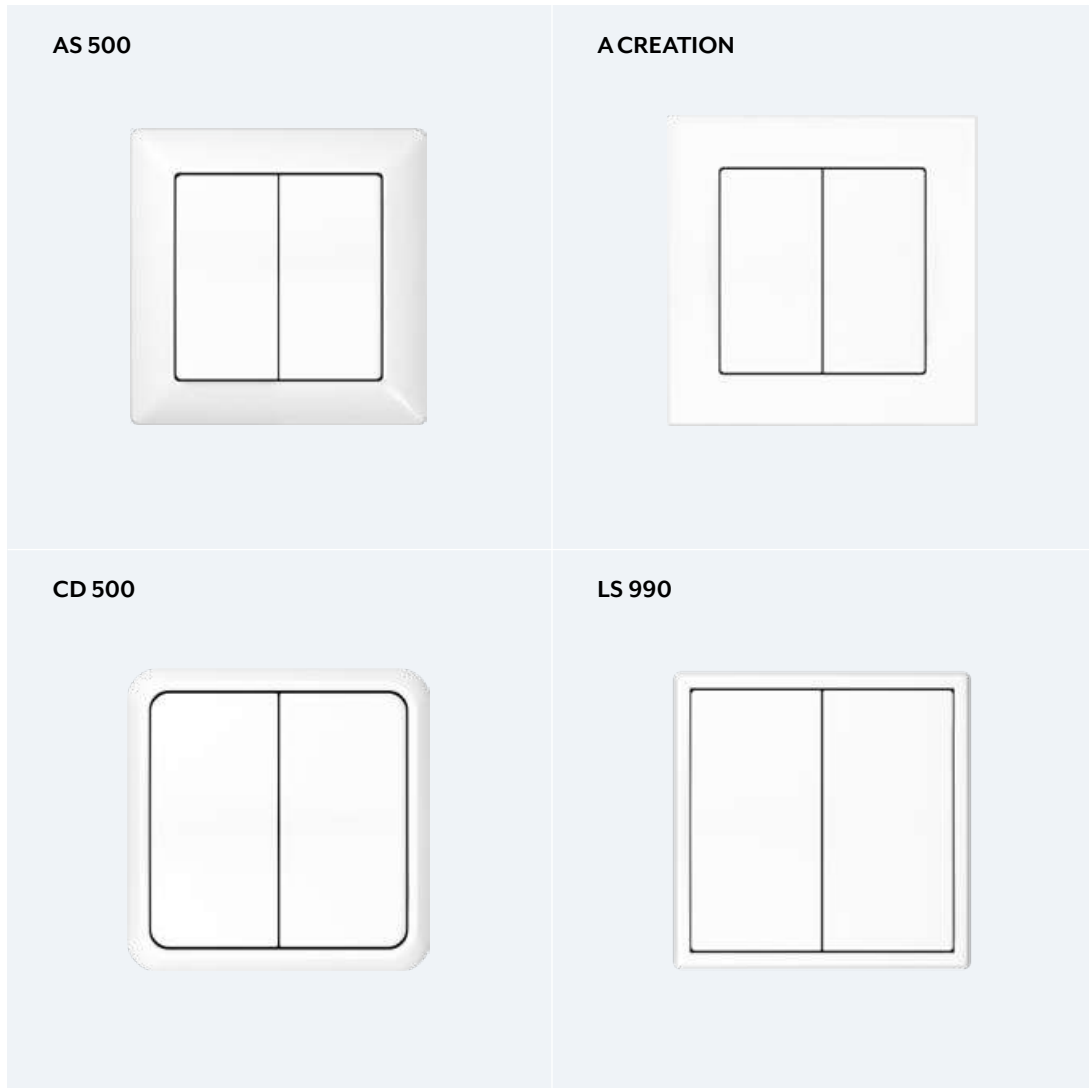

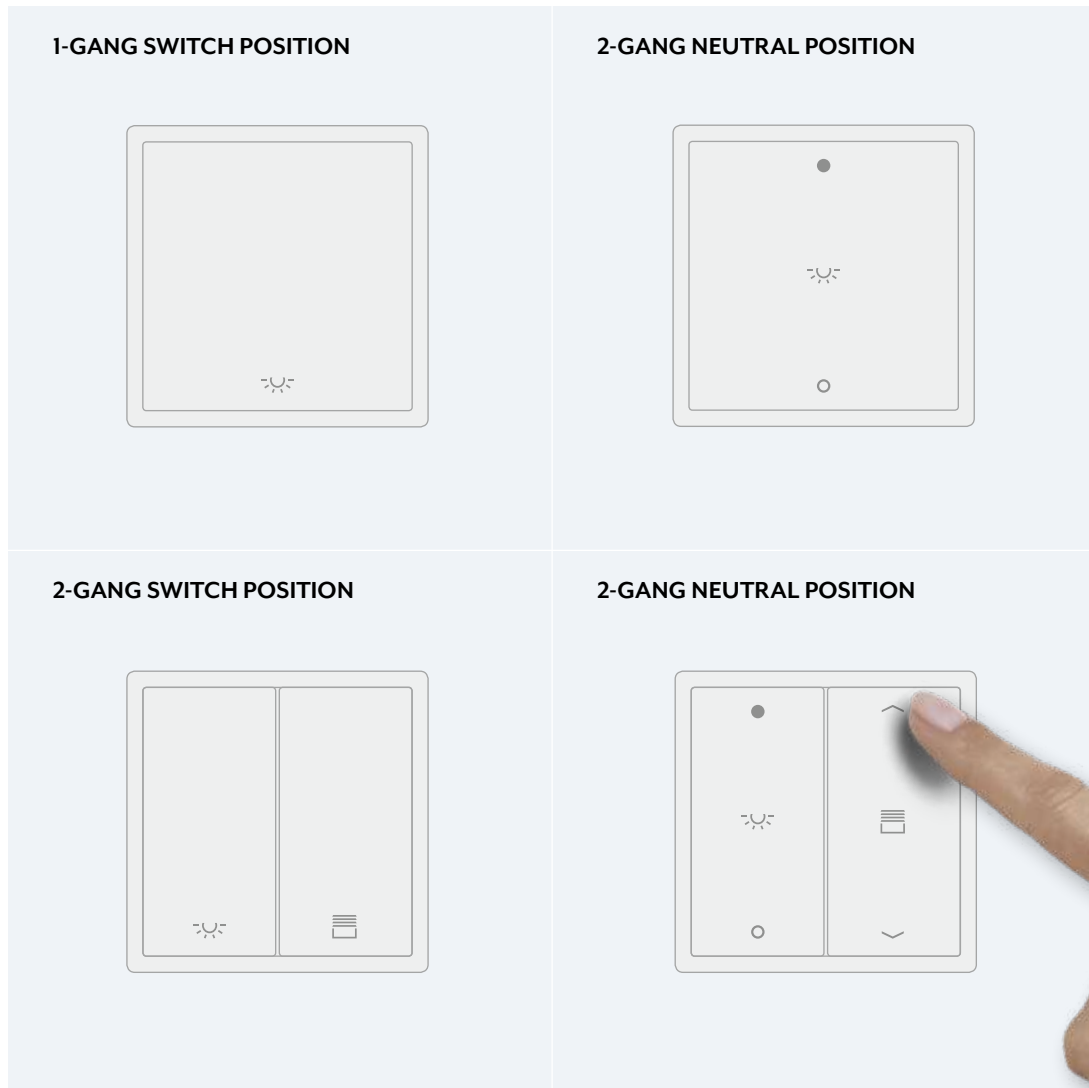

Attractive appearance for the BCU push-buttons with the AS, A, CD and LS ranges. Form, material and variety of colours determine the JUNG design. They harmoniously blend in to the remaining electrical installation.

# Designs and operation



The push-button BCUs are available in four versions depending on the application. The desired parameters can be programmed using the ETS software. The devices with neutral position have a multiple function capability by operating the rocker „up“ and „down“. Two single-colour LEDs are used for floor pilot lighting or for status display and can also be set using parameters.

-  Colour printing possible
-  Laser labelling possible



Ref.-no.

Depending on the version of the push-button BCU – 1-gang rocker or 2-gang rocker – centre plates are used with and without indication lights.

The “upper” or “lower” rockers can be controlled with the push-button with “neutral position”, while only the “lower” rocker can be pressed with the push-button with “switch position”. The push-button BCU can only function with an application program i.e. the push-button BCU consists of the device (hardware) and the application program (software).

**Push-button BCU, neutral position**

Function: switching, dimming, shutter control  
LED: always ON, always OFF, status indication

1-gang **4071.02 LED**

Status indication is possible with LED

**Push-button BCU, switch position**

Function: switching, dimming  
LED: always ON, always OFF

Can be converted into pull cord push-button by means of pull cord insert ref.-no. 34 KO5 and rocker with lens.

1-gang **4071.01 LED**

Status indication is possible with LED

**Rockers for AS range**

Antibacterial version on request.

When wallpapering, avoid wallpaper on the supporting frame of the insert.





**1-gang rocker, full plate**

**for 1-gang push-button BCU**

**neutral position ref.-no.: 4071.02 LED**

**switch position ref.-no.: 4071.01 LED**

**Duroplastic (scratch-proof) glossy**

ivory	full plate		<b>AS 590</b>
	centre plate		<b>AS 591</b>
white	full plate		<b>AS 590 WW</b>
	centre plate		<b>AS 591 WW</b>

**1-gang rocker with symbols, full plate**

**for 1-gang push-button BCU**

**neutral position ref.-no.: 4071.02 LED**

**Duroplastic (scratch-proof) glossy**

ivory	full plate		<b>AS 590 P</b>
	centre plate		<b>AS 591 P</b>
white	full plate		<b>AS 590 P WW</b>
	centre plate		<b>AS 591 P WW</b>





**1-gang rocker with lens, full plate**

**for 1-gang push-button BCU**

**neutral position ref.-no.: 4071.02 LED**

**switch position ref.-no.: 4071.01 LED**

**Duroplastic (scratch-proof) glossy**

ivory	full plate		<b>AS 590 KO5</b>
	centre plate		<b>AS 591 KO5</b>
white	full plate		<b>AS 590 KO5 WW</b>
	centre plate		<b>AS 591 KO5 WW</b>

		Ref.-no.
<b>1-gang rocker with lens and symbols, full plate</b>		
<b>for 1-gang push-button BCU</b>		
<b>neutral position ref.-no.: 4071.02 LED</b>		
<b>Duroplastic (scratch-proof) glossy</b>		
ivory	full plate	<b>AS 590 KO5P</b>
	centre plate	<b>AS 591 KO5P</b>
white	full plate	<b>AS 590 KO5P WW</b>
	centre plate	<b>AS 591 KO5P WW</b>

### Rockers for A range

When wallpapering, avoid wallpaper on the supporting frame of the insert.

#### 1-gang rocker

**for 1-gang push-button BCU**

**neutral position ref.-no.: 4071.02 LED**

**switch position ref.-no.: 4071.01 LED**

**Duroplastic (scratch-proof) glossy**

white	P	<b>A 590 WW</b>
black		<b>A 590 SW</b>

**Duroplastic lacquered**

aluminium	P L	<b>A 590 AL</b>
champagne	P	<b>A 590 CH</b>
mocha		<b>A 590 MO</b>

**Thermoplastic (breakproof) high-gloss**

white	L	<b>A 590 BF WW</b>
black	L	<b>A 590 BF SW</b>

**Thermoplastic (breakproof) lacquered**

matt anthracite	L	<b>A 590 BF ANM</b>
-----------------	---	---------------------

#### 1-gang rocker with symbols

**for 1-gang push-button BCU**

**neutral position ref.-no.: 4071.02 LED**

**Duroplastic (scratch-proof) glossy**

white	<b>A 590 P WW</b>
black	<b>A 590 P SW</b>

**Duroplastic lacquered**

aluminium	<b>A 590 P AL</b>
champagne	<b>A 590 P CH</b>
mocha	<b>A 590 P MO</b>

**Thermoplastic (breakproof) high-gloss**

white	<b>A 590 BF P WW</b>
black	<b>A 590 BF P SW</b>

**Thermoplastic (breakproof) lacquered**

matt anthracite	<b>A 590 BF P ANM</b>
-----------------	-----------------------



 Colour printing possible

 Laser labelling possible



Ref.-no.

**1-gang rocker with lens**  
**for 1-gang push-button BCU**  
**neutral position ref.-no.: 4071.02 LED**  
**switch position ref.-no.: 4071.01 LED**  
**Duroplastic (scratch-proof) glossy**

white  **A 590 KO5 WW**

black **A 590 KO5 SW**

**Duroplastic lacquered**

aluminium   **A 590 KO5 AL**

champagne  **A 590 KO5 CH**

mocha **A 590 KO5 MO**

**Thermoplastic (breakproof) high-gloss**

white  **A 590 BF KO5 WW**

black  **A 590 BF KO5 SW**

**Thermoplastic (breakproof) lacquered**

matt anthracite  **A 590 BF KO5 ANM**

**1-gang rocker with lens and symbols**  
**for 1-gang push-button BCU**  
**neutral position ref.-no.: 4071.02 LED**  
**Duroplastic (scratch-proof) glossy**

white **A 590 KO5P WW**

black **A 590 KO5P SW**

**Duroplastic lacquered**

aluminium **A 590 KO5P AL**

champagne **A 590 KO5P CH**

mocha **A 590 KO5P MO**

**Thermoplastic (breakproof) high-gloss**

white **A 590 BF KO5P WW**

black **A 590 BF KO5P SW**

**Thermoplastic (breakproof) lacquered**

matt anthracite **A 590 BF KO5P ANM**

**Rockers for CD range**

**1-gang rocker**  
**for 1-gang push-button BCU**  
**neutral position ref.-no.: 4071.02 LED**  
**switch position ref.-no.: 4071.01 LED**  
**Duroplastic (scratch-proof) glossy**

ivory  **CD 590**

white  **CD 590 WW**

brown **CD 590 BR**

grey **CD 590 GR**

light grey  **CD 590 LG**

black **CD 590 SW**

**metal versions (anodized aluminium)**

gold-bronze  **CD 590 GB**

platinum  **CD 590 PT**

	Ref.-no.
<b>Rockers for CD range</b>	
<b>1-gang rocker with symbols for 1-gang push-button BCU neutral position ref.-no.: 4071.02 LED Duroplastic (scratch-proof) glossy</b>	
ivory	CD 590 P
white	CD 590 P WW
brown	CD 590 P BR
grey	CD 590 P GR
light grey	CD 590 P LG
black	CD 590 P SW
<b>metal versions (anodized aluminium)</b>	
gold-bronze	CD 590 P GB
platinum	CD 590 P PT
<b>1-gang rocker with inscription field 9 x 58 mm for 1-gang push-button BCU neutral position ref.-no.: 4071.02 LED switch position ref.-no.: 4071.01 LED Duroplastic (scratch-proof) glossy</b>	
ivory	P CD 590 NA
white	P CD 590 NA WW
brown	CD 590 NA BR
grey	CD 590 NA GR
light grey	P CD 590 NA LG
black	CD 590 NA SW
<b>Transparent cover with paper inlay for inscription field 9 x 58 mm (Spare part)</b>	
paper inlay white	CD 90 NA
<b>1-gang rocker with lens for 1-gang push-button BCU neutral position ref.-no.: 4071.02 LED switch position ref.-no.: 4071.01 LED Duroplastic (scratch-proof) glossy</b>	
ivory	P CD 590 KO5
white	P CD 590 KO5 WW
brown	CD 590 KO5 BR
grey	CD 590 KO5 GR
light grey	P CD 590 KO5 LG
black	CD 590 KO5 SW
<b>metal versions (anodized aluminium)</b>	
gold-bronze	L CD 590 KO5 GB
platinum	L CD 590 KO5 PT





 Colour printing possible

 Laser labelling possible



Ref.-no.

#### Rockers for CD range

**1-gang rocker with lens and symbols  
for 1-gang push-button BCU  
neutral position ref.-no.: 4071.02 LED**

**Duroplastic (scratch-proof) glossy**

ivory	CD 590 KO5P
white	CD 590 KO5P WW
brown	CD 590 KO5P BR
grey	CD 590 KO5P GR
light grey	CD 590 KO5P LG
black	CD 590 KO5P SW

**metal versions (anodized aluminium)**

gold-bronze	CD 590 KO5P GB
platinum	CD 590 KO5P PT

**1-gang rocker with lens and inscription field 9 x 58 mm  
for 1-gang push-button BCU**

**neutral position ref.-no.: 4071.02 LED**

**switch position ref.-no.: 4071.01 LED**

**Duroplastic (scratch-proof) glossy**

ivory	 CD 590 NAK05
white	 CD 590 NAK05 WW
brown	CD 590 NAK05 BR
grey	CD 590 NAK05 GR
light grey	 CD 590 NAK05 LG
black	CD 590 NAK05 SW

**Transparent cover with paper inlay**

for inscription field 9 x 58 mm

(Spare part)

paper inlay white	CD 90 NA
-------------------	----------

#### Rockers for SL range

**1-gang rocker  
for 1-gang push-button BCU**

**switch position ref.-no.: 4071.01 LED**

white	SL 590 WW
gold-bronze	SL 590 GB
black	SL 590 SW

**1-gang rocker with lens  
for 1-gang push-button BCU**

**switch position ref.-no.: 4071.01 LED**

white	SL 590 KO5 WW
gold-bronze	SL 590 KO5 GB
black	SL 590 KO5 SW

	Ref.-no.
<b>Rockers for LS range</b>	
<b>1-gang rocker</b>	
<b>for 1-gang push-button BCU</b>	
<b>neutral position ref.-no.: 4071.02 LED</b>	
<b>switch position ref.-no.: 4071.01 LED</b>	
<b>Duroplastic (scratch-proof) glossy</b>	
ivory	P LS 990
white	P LS 990 WW
light grey	P LS 990 LG
black	LS 990 SW
<b>metal versions</b>	
aluminium	P L AL 2990
stainless steel	L ES 2990
anthracite (aluminium lacquered)	L AL 2990 AN
dark (aluminium lacquered)	L AL 2990 D
chrome	GCR 2990
gold-coloured	GO 2990
gold-plated	LS 990 GGO
classic brass	P ME 2990 C
antique brass	ME 2990 AT
<b>1-gang rocker with symbols</b>	
<b>for 1-gang push-button BCU</b>	
<b>neutral position ref.-no.: 4071.02 LED</b>	
<b>Duroplastic (scratch-proof) glossy</b>	
ivory	LS 990 P
white	LS 990 P WW
light grey	LS 990 P LG
black	LS 990 P SW
<b>metal versions</b>	
aluminium	AL 2990 P
stainless steel	ES 2990 P
anthracite (aluminium lacquered)	AL 2990 P AN
<b>1-gang rocker with inscription field 9 x 58 mm</b>	
<b>for 1-gang push-button BCU</b>	
<b>neutral position ref.-no.: 4071.02 LED</b>	
<b>switch position ref.-no.: 4071.01 LED</b>	
<b>Duroplastic (scratch-proof) glossy</b>	
ivory	P LS 990 NA
white	P LS 990 NA WW
light grey	P LS 990 NA LG
black	LS 990 NA SW
<b>Transparent cover with paper inlay</b>	
for inscription field 9 x 58 mm	
(Spare part)	
paper inlay white	CD 90 NA



**P** Colour printing possible

**L** Laser labelling possible

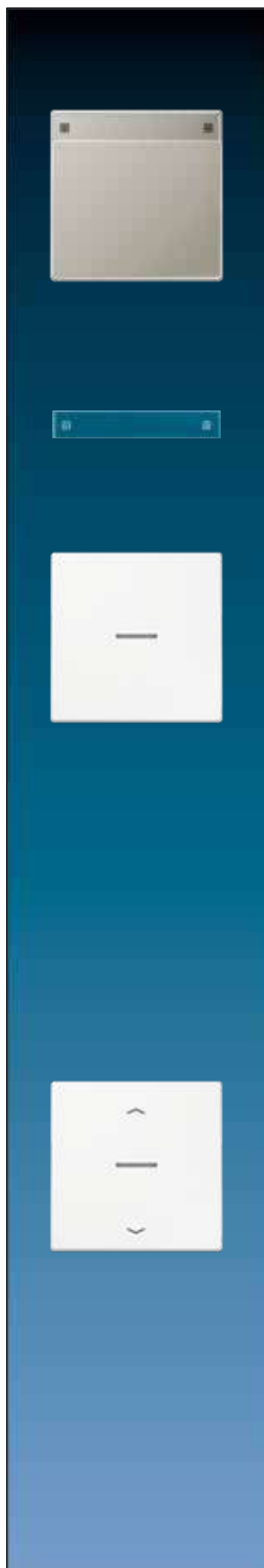

Ref.-no.

#### Rockers for LS range

##### 1-gang rocker with inscription field 12 x 55 mm

##### for 1-gang push-button BCU

neutral position ref.-no.: 4071.02 LED

switch position ref.-no.: 4071.01 LED

##### metal versions

aluminium	<b>P</b> <b>L</b>	AL 2990 NA
stainless steel	<b>L</b>	ES 2990 NA
anthracite (aluminium lacquered)	<b>L</b>	AL 2990 NA AN
dark (aluminium lacquered)	<b>L</b>	AL 2990 NA D
classic brass	<b>P</b>	ME 2990 NA C
antique brass		ME 2990 NA AT

##### Transparent cover

for inscription field 12 x 55 mm

(Spare part)

M 20 NA

##### 1-gang rocker with lens

##### for 1-gang push-button BCU

neutral position ref.-no.: 4071.02 LED

switch position ref.-no.: 4071.01 LED

##### Duroplastic (scratch-proof) glossy

ivory	<b>P</b>	LS 990 KO5
white	<b>P</b>	LS 990 KO5 WW
light grey	<b>P</b>	LS 990 KO5 LG
black		LS 990 KO5 SW

##### metal versions

aluminium	<b>P</b> <b>L</b>	AL 2990 KO5
stainless steel	<b>L</b>	ES 2990 KO5
anthracite (aluminium lacquered)	<b>L</b>	AL 2990 KO5 AN
dark (aluminium lacquered)	<b>L</b>	AL 2990 KO5 D
chrome		GCR 2990 KO5
gold-coloured		GO 2990 KO5
gold-plated		LS 990 KO5 GGO
classic brass	<b>P</b>	ME 2990 KO5 C
antique brass		ME 2990 KO5 AT

##### 1-gang rocker with lens and symbols

##### for 1-gang push-button BCU

neutral position ref.-no.: 4071.02 LED

##### Duroplastic (scratch-proof) glossy

ivory		LS 990 KO5P
white		LS 990 KO5P WW
light grey		LS 990 KO5P LG
black		LS 990 KO5P SW

##### metal versions

aluminium		AL 2990 KO5P
stainless steel		ES 2990 KO5P
anthracite (aluminium lacquered)		AL 2990 KO5P AN

Ref.-no.

Depending on the version of the push-button BCU – 1-gang rocker or 2-gang rocker – centre plates are used with and without indication lights.

The “upper” or “lower” rockers can be controlled with the push-button with “neutral position”, while only the “lower” rocker can be pressed with the push-button with “switch position”. The push-button BCU can only function with an application program i.e. the push-button BCU consists of the device (hardware) and the application program (software).

### Push-button BCU, neutral position

Function: switching, dimming, shutter control

LED: always ON, always OFF, status indication

2-gang **4072.02 LED**

Status indication is possible with LED

### Push-button BCU, switch position

Function: switching, dimming, shutter control

LED: always ON, always OFF

2-gang **4072.01 LED**

Status indication is possible with LED

### Rockers for AS range

Antibacterial version on request.

When wallpapering, avoid wallpaper on the supporting frame of the insert.

#### 2-gang rocker, full plate

##### for 2-gang push-button BCU

neutral position ref.-no.: 4072.02 LED

switch position ref.-no.: 4072.01 LED

#### Duroplastic (scratch-proof) glossy

ivory	full plate	P	AS 590-5
	centre plate	P	AS 591-5
white	full plate	P	AS 590-5 WW
	centre plate	P	AS 591-5 WW

#### 2-gang rocker with symbols, full plate

##### for 2-gang push-button BCU

neutral position ref.-no.: 4072.02 LED

#### Duroplastic (scratch-proof) glossy

ivory	full plate	AS 590-5 MP
	centre plate	AS 591-5 MP
white	full plate	AS 590-5 MP WW
	centre plate	AS 591-5 MP WW

#### 2-gang rocker with symbols, full plate

##### for 2-gang push-button BCU

switch position ref.-no.: 4072.01 LED

#### Duroplastic (scratch-proof) glossy

ivory	full plate	AS 590-5 P
	centre plate	AS 591-5 P
white	full plate	AS 590-5 P WW
	centre plate	AS 591-5 P WW

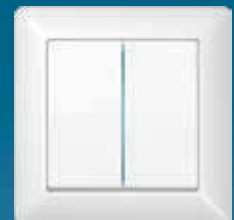

 Colour printing possible

 Laser labelling possible







Ref.-no.

#### Rockers for AS range

**2-gang rocker with lens, full plate  
for 2-gang push-button BCU**  
neutral position ref.-no.: 4072.02 LED  
switch position ref.-no.: 4072.01 LED

##### Duroplastic (scratch-proof) glossy

ivory	full plate		AS 590-5 KO5
	centre plate		AS 591-5 KO5
white	full plate		AS 590-5 KO5 WW
	centre plate		AS 591-5 KO5 WW

**2-gang rocker with lens and symbols, full plate  
for 2-gang push-button BCU**  
neutral position ref.-no.: 4072.02 LED

##### Duroplastic (scratch-proof) glossy

ivory	full plate	AS 590-5 KO5MP
	centre plate	AS 591-5 KO5MP
white	full plate	AS 590-5 KO5MP WW
	centre plate	AS 591-5 KO5MP WW

**2-gang rocker with lens and symbols, full plate  
for 2-gang push-button BCU**  
switch position ref.-no.: 4072.01 LED

##### Duroplastic (scratch-proof) glossy

ivory	full plate	AS 590-5 KO5P
	centre plate	AS 591-5 KO5P
white	full plate	AS 590-5 KO5P WW
	centre plate	AS 591-5 KO5P WW

#### Rockers for A range



When wallpapering, avoid wallpaper on the supporting frame of the insert.

**2-gang rocker  
for 2-gang push-button BCU**  
neutral position ref.-no.: 4072.02 LED  
switch position ref.-no.: 4072.01 LED

##### Duroplastic (scratch-proof) glossy

white		A 595 WW
black		A 595 SW

##### Duroplastic lacquered

aluminium	 	A 595 AL
champagne		A 595 CH
mocha		A 595 MO

##### Thermoplastic (breakproof) high-gloss

white		A 595 BF WW
black		A 595 BF SW

##### Thermoplastic (breakproof) lacquered

matt anthracite		A 595 BF ANM
-----------------	---	--------------

Ref.-no.

## Rockers for A range

When wallpapering, avoid wallpaper on the supporting frame of the insert.

### 2-gang rocker with symbols for 2-gang push-button BCU neutral position ref.-no.: 4072.02 LED

#### Duroplastic (scratch-proof) glossy

white	A 595 MP WW
black	A 595 MP SW

#### Duroplastic lacquered

aluminium	A 595 MP AL
champagne	A 595 MP CH
mocha	A 595 MP MO

#### Thermoplastic (breakproof) high-gloss

white	A 595 BF MP WW
black	A 595 BF MP SW

#### Thermoplastic (breakproof) lacquered

matt anthracite	A 595 BF MP ANM
-----------------	-----------------

### 2-gang rocker with symbols for 2-gang push-button BCU switch position ref.-no.: 4072.01 LED

#### Duroplastic (scratch-proof) glossy

white	A 595 P WW
black	A 595 P SW

#### Duroplastic lacquered

aluminium	A 595 P AL
champagne	A 595 P CH
mocha	A 595 P MO

#### Thermoplastic (breakproof) high-gloss

white	A 595 BF P WW
black	A 595 BF P SW

#### Thermoplastic (breakproof) lacquered



matt anthracite	A 595 BF P ANM
-----------------	----------------

### 2-gang rocker with lens for 2-gang push-button BCU neutral position ref.-no.: 4072.02 LED switch position ref.-no.: 4072.01 LED



#### Duroplastic (scratch-proof) glossy

white	 A 595 KO5 WW
black	A 595 KO5 SW

#### Duroplastic lacquered

aluminium	  A 595 KO5 AL
champagne	 A 595 KO5 CH
mocha	A 595 KO5 MO

#### Thermoplastic (breakproof) high-gloss

white	 A 595 BF KO5 WW
black	 A 595 BF KO5 SW

#### Thermoplastic (breakproof) lacquered

matt anthracite	 A 595 BF KO5 ANM
-----------------	--





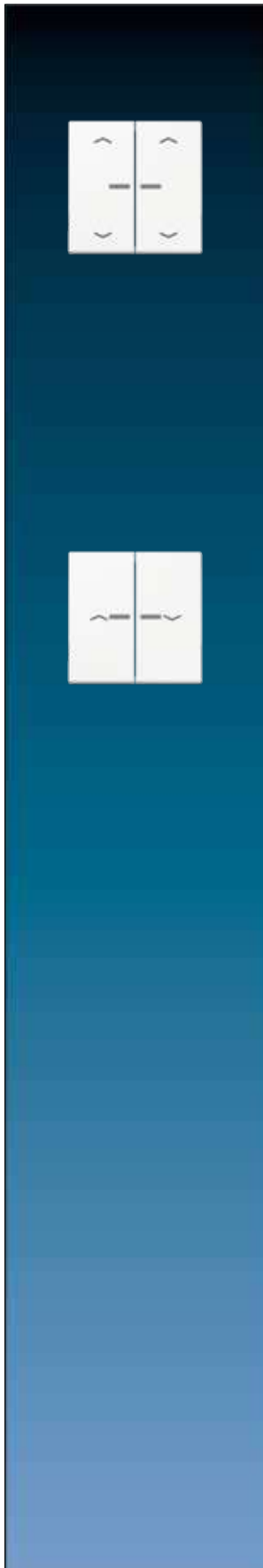

Ref.-no.

**Rockers for A range**

When wallpapering, avoid wallpaper on the supporting frame of the insert.

**2-gang rocker with lens and symbols  
for 2-gang push-button BCU  
neutral position ref.-no.: 4072.02 LED****Duroplastic (scratch-proof) glossy**

white	A 595 KO5MP WW
black	A 595 KO5MP SW

**Duroplastic lacquered**

aluminium	A 595 KO5MP AL
champagne	A 595 KO5MP CH
mocha	A 595 KO5MP MO

**Thermoplastic (breakproof) high-gloss**

white	A 595 BF KO5MP WW
black	A 595 BF KO5MP SW

**Thermoplastic (breakproof) lacquered**

matt anthracite	A 595 BF KO5MP ANM
-----------------	--------------------

**2-gang rocker with lens and symbols  
for 2-gang push-button BCU  
switch position ref.-no.: 4072.01 LED****Duroplastic (scratch-proof) glossy**

white	A 595 KO5P WW
black	A 595 KO5P SW

**Duroplastic lacquered**

aluminium	A 595 KO5P AL
champagne	A 595 KO5P CH
mocha	A 595 KO5P MO

**Thermoplastic (breakproof) high-gloss**

white	A 595 BF KO5P WW
black	A 595 BF KO5P SW

**Thermoplastic (breakproof) lacquered**

matt anthracite	A 595 BF KO5P ANM
-----------------	-------------------

**P** Colour printing possible

**L** Laser labelling possible

Ref.-no.

## Rockers for CD range

### 2-gang rocker

for 2-gang push-button BCU

neutral position ref.-no.: 4072.02 LED

switch position ref.-no.: 4072.01 LED

**Duroplastic (scratch-proof) glossy**

ivory	<b>P</b>	<b>CD 595</b>
white	<b>P</b>	<b>CD 595 WW</b>
brown		<b>CD 595 BR</b>
grey		<b>CD 595 GR</b>
light grey	<b>P</b>	<b>CD 595 LG</b>
black		<b>CD 595 SW</b>

**metal versions (anodized aluminium)**

gold-bronze	<b>L</b>	<b>CD 595 GB</b>
platinum	<b>L</b>	<b>CD 595 PT</b>

### 2-gang rocker with symbols

for 2-gang push-button BCU

neutral position ref.-no.: 4072.02 LED

**Duroplastic (scratch-proof) glossy**

ivory		<b>CD 595 MP</b>
white		<b>CD 595 MP WW</b>
brown		<b>CD 595 MP BR</b>
grey		<b>CD 595 MP GR</b>
light grey		<b>CD 595 MP LG</b>
black		<b>CD 595 MP SW</b>

**metal versions (anodized aluminium)**

gold-bronze		<b>CD 595 MP GB</b>
platinum		<b>CD 595 MP PT</b>

### 2-gang rocker with symbols

for 2-gang push-button BCU

switch position ref.-no.: 4072.01 LED

**Duroplastic (scratch-proof) glossy**

ivory		<b>CD 595 P</b>
white		<b>CD 595 P WW</b>
brown		<b>CD 595 P BR</b>
grey		<b>CD 595 P GR</b>
light grey		<b>CD 595 P LG</b>
black		<b>CD 595 P SW</b>

**metal versions (anodized aluminium)**

gold-bronze		<b>CD 595 P GB</b>
platinum		<b>CD 595 P PT</b>

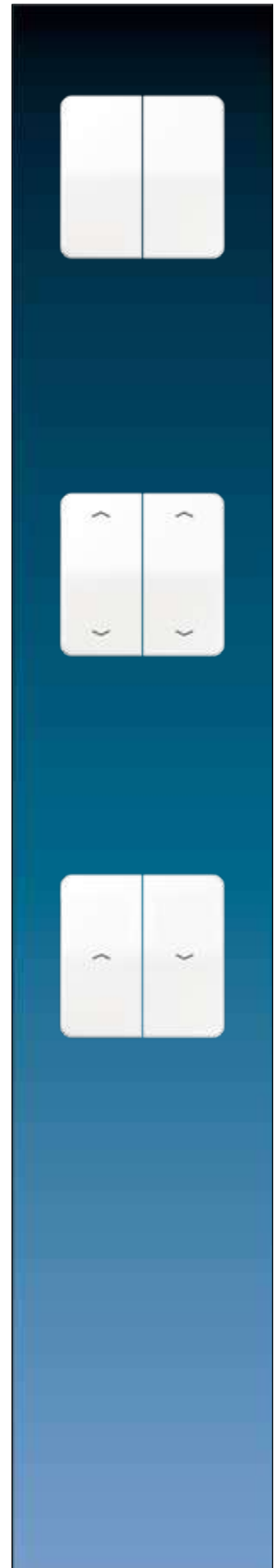

 Colour printing possible

 Laser labelling possible

Ref.-no.



### Rockers for CD range

**2-gang rocker with lens  
for 2-gang push-button BCU**  
neutral position ref.-no.: 4072.02 LED  
switch position ref.-no.: 4072.01 LED

**Duroplastic (scratch-proof) glossy**

ivory		CD 595 KO5
white		CD 595 KO5 WW
brown		CD 595 KO5 BR
grey		CD 595 KO5 GR
light grey		CD 595 KO5 LG
black		CD 595 KO5 SW

**metal versions (anodized aluminium)**

gold-bronze		CD 595 KO5 GB
platinum		CD 595 KO5 PT

**2-gang rocker with lens and symbols  
for 2-gang push-button BCU**  
neutral position ref.-no.: 4072.02 LED

**Duroplastic (scratch-proof) glossy**

ivory		CD 595 KO5MP
white		CD 595 KO5MP WW
brown		CD 595 KO5MP BR
grey		CD 595 KO5MP GR
light grey		CD 595 KO5MP LG
black		CD 595 KO5MP SW

**metal versions (anodized aluminium)**

gold-bronze		CD 595 KO5MP GB
platinum		CD 595 KO5MP PT

**2-gang rocker with lens and symbols  
for 2-gang push-button BCU**  
switch position ref.-no.: 4072.01 LED

**Duroplastic (scratch-proof) glossy**

ivory		CD 595 KO5P
white		CD 595 KO5P WW
brown		CD 595 KO5P BR
grey		CD 595 KO5P GR
light grey		CD 595 KO5P LG
black		CD 595 KO5P SW

**metal versions (anodized aluminium)**

gold-bronze		CD 595 KO5P GB
platinum		CD 595 KO5P PT

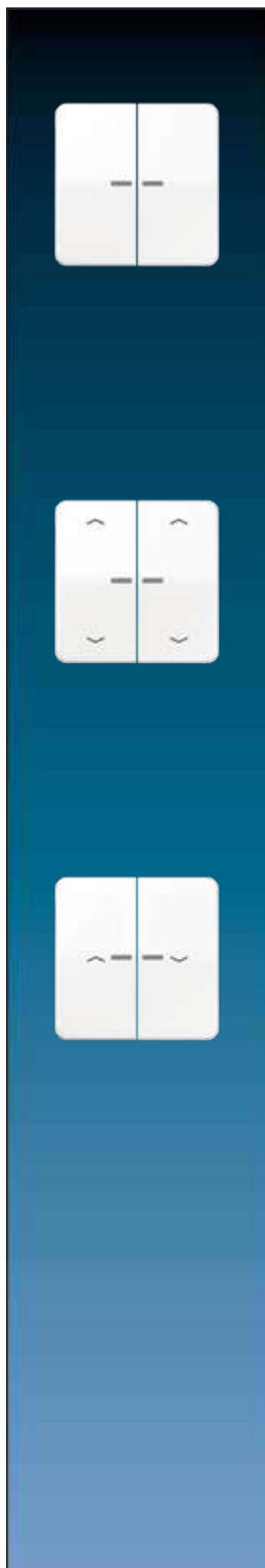

	Ref.-no.
<b>Rockers for SL range</b>	
<b>2-gang rocker for 2-gang push-button BCU switch position ref.-no.: 4072.01 LED</b>	
white	<b>SL 595 WW</b>
gold-bronze	<b>SL 595 GB</b>
black	<b>SL 595 SW</b>
<b>2-gang rocker with symbols for 2-gang push-button BCU switch position ref.-no.: 4072.01 LED</b>	
white	<b>SL 595 P WW</b>
gold-bronze	<b>SL 595 P GB</b>
black	<b>SL 595 P SW</b>
<b>2-gang rocker with lens for 2-gang push-button BCU switch position ref.-no.: 4072.01 LED</b>	
white	<b>SL 595 KO5 WW</b>
gold-bronze	<b>SL 595 KO5 GB</b>
black	<b>SL 595 KO5 SW</b>
<b>2-gang rocker with lens and symbols for 2-gang push-button BCU switch position ref.-no.: 4072.01 LED</b>	
white	<b>SL 595 KO5P WW</b>
gold-bronze	<b>SL 595 KO5P GB</b>
black	<b>SL 595 KO5P SW</b>

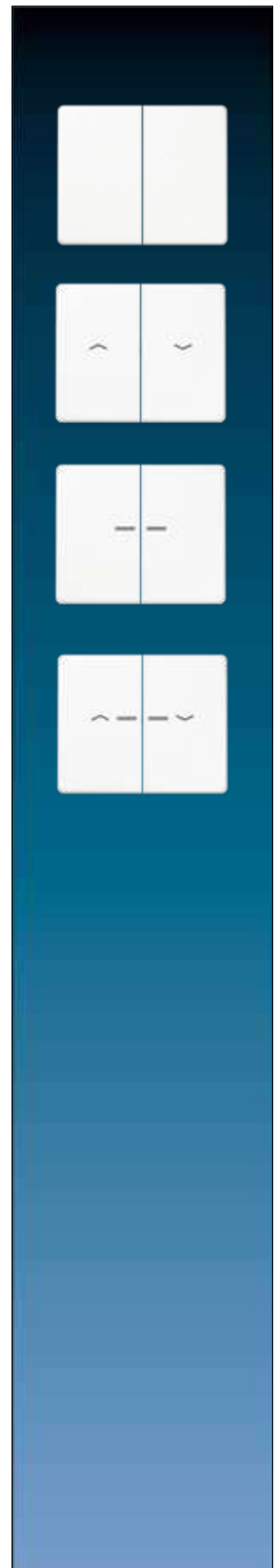

 Colour printing possible

 Laser labelling possible



Ref.-no.

### Rockers for LS range



#### 2-gang rocker

for 2-gang push-button BCU





neutral position ref.-no.: 4072.02 LED

switch position ref.-no.: 4072.01 LED

Duroplastic (scratch-proof) glossy

ivory		LS 995
white		LS 995 WW
light grey		LS 995 LG
black		LS 995 SW

#### metal versions

aluminium	 	AL 2995
stainless steel		ES 2995
anthracite (aluminium lacquered)		AL 2995 AN
dark (aluminium lacquered)		AL 2995 D
chrome		GCR 2995
gold-coloured		GO 2995
gold-plated		LS 995 GGO
classic brass		ME 2995 C
antique brass		ME 2995 AT

#### 2-gang rocker with symbols

for 2-gang push-button BCU

neutral position ref.-no.: 4072.02 LED

Duroplastic (scratch-proof) glossy

ivory		LS 995 MP
white		LS 995 MP WW
light grey		LS 995 MP LG
black		LS 995 MP SW

#### metal versions

aluminium		AL 2995 MP
stainless steel		ES 2995 MP
anthracite (aluminium lacquered)		AL 2995 MP AN

#### 2-gang rocker with symbols

for 2-gang push-button BCU

switch position ref.-no.: 4072.01 LED

Duroplastic (scratch-proof) glossy

ivory		LS 995 P
white		LS 995 P WW
light grey		LS 995 P LG
black		LS 995 P SW

#### metal versions

aluminium		AL 2995 P
stainless steel		ES 2995 P
anthracite (aluminium lacquered)		AL 2995 P AN
dark (aluminium lacquered)		AL 2995 P D
chrome		GCR 2995 P
gold-coloured		GO 2995 P
classic brass		ME 2995 P C
antique brass		ME 2995 P AT

	Ref.-no.
<b>Rockers for LS range</b>	
<b>2-gang rocker with lens for 2-gang push-button BCU neutral position ref.-no.: 4072.02 LED switch position ref.-no.: 4072.01 LED Duroplastic (scratch-proof) glossy</b>	
ivory	P LS 995 KO5
white	P LS 995 KO5 WW
light grey	P LS 995 KO5 LG
black	LS 995 KO5 SW
<b>metal versions</b>	
aluminium	P L AL 2995 KO5
stainless steel	L ES 2995 KO5
anthracite (aluminium lacquered)	L AL 2995 KO5 AN
dark (aluminium lacquered)	L AL 2995 KO5 D
chrome	GCR 2995 KO5
gold-coloured	GO 2995 KO5
classic brass	P ME 2995 KO5 C
antique brass	ME 2995 KO5 AT
<b>2-gang rocker with lens and symbols for 2-gang push-button BCU neutral position ref.-no.: 4072.02 LED Duroplastic (scratch-proof) glossy</b>	
ivory	LS 995 KO5MP
white	LS 995 KO5MP WW
light grey	LS 995 KO5MP LG
black	LS 995 KO5MP SW
<b>metal versions</b>	
aluminium	AL 2995 KO5MP
stainless steel	ES 2995 KO5MP
anthracite (aluminium lacquered)	AL 2995 KO5MP AN
<b>2-gang rocker with lens and symbols for 2-gang push-button BCU switch position ref.-no.: 4072.01 LED Duroplastic (scratch-proof) glossy</b>	
ivory	LS 995 KO5P
white	LS 995 KO5P WW
light grey	LS 995 KO5P LG
black	LS 995 KO5P SW
<b>metal versions</b>	
aluminium	AL 2995 KO5P
stainless steel	ES 2995 KO5P
anthracite (aluminium lacquered)	AL 2995 KO5P AN







Ref.-no.

Depending on the version of the push-button BCU – 1-gang rocker or 2-gang rocker – centre plates are used with and without indication lights.

The “upper” or “lower” rockers can be controlled with the push-button with “neutral position”, while only the “lower” rocker can be pressed with the push-button with “switch position”. The push-button BCU can only function with an application program i.e. the push-button BCU consists of the device (hardware) and the application program (software).

**Push-button BCU, neutral position**

Function: switching, dimming, shutter control  
LED: always ON, always OFF, status indication

1-gang

**8471.02 LED W**

Status indication is possible with LED

**Push-button BCU, switch position**

Function: switching, dimming  
LED: always ON, always OFF

1-gang

**8471.01 LED W**

Status indication is possible with LED

**1-gang rocker with lens**

for 1-gang push-button BCU  
neutral position ref.-no.: 8471.02 LED W  
switch position ref.-no.: 8471.01 LED W

**800 NT****1-gang rocker with lens and symbols**

for 1-gang push-button BCU  
neutral position ref.-no.: 8471.02 LED W

**800 P****Rocker with inscription field**

for 1-gang push-button BCU  
neutral position ref.-no.: 8471.02 LED W  
switch position ref.-no.: 8471.01 LED W

with inscription field 22 x 48 mm

**800 NA****1-gang rocker with great lens**

for 1-gang push-button BCU  
neutral position ref.-no.: 8471.02 LED W  
switch position ref.-no.: 8471.01 LED W

with red symbol

**800 KO**

		Ref.-no.
<b>Symbols</b>		
<b>for switches and push-buttons with indicator light</b>		
anthracite	symbol light	<b>33 AN L</b>
	symbol bell	<b>33 AN K</b>
	symbol door	<b>33 AN T</b>
	neutral	<b>33 AN N</b>
green	neutral	<b>33 GN</b>
transparent	neutral	<b>33 KLAR</b>
red	neutral	<b>33 NR</b>
<b>Push-button BCU, neutral position</b>		
Function: switching, dimming, shutter control		
LED: always ON, always OFF, status indication		
2-gang		<b>8472.02 LED W</b>
Status indication is possible with LED		
<b>Push-button BCU, switch position</b>		
Function: switching, dimming, shutter control		
LED: always ON, always OFF		
2-gang		<b>8472.01 LED W</b>
Status indication is possible with LED		
<b>2-gang rocker with lens</b>		
<b>for 2-gang push-button BCU</b>		
<b>neutral position ref.-no.: 8472.02 LED W</b>		
<b>switch position ref.-no.: 8472.01 LED W</b>		
		<b>805 NT</b>
<b>2-gang rocker with lens and symbols</b>		
<b>for 2-gang push-button BCU</b>		
<b>switch position ref.-no.: 8472.01 LED W</b>		
		<b>805 P</b>
<b>2-gang rocker with lens and symbols</b>		
<b>for 2-gang push-button BCU</b>		
<b>neutral position ref.-no.: 8472.02 LED W</b>		
		<b>805 MP</b>



# Presence Detector Mini

**KNX PRESENCE DETECTOR MINI**

Available in the Standard and Universal versions

Unobtrusive, compact, precise: the KNX Presence Detector Mini is all of these. It is designed to control lighting systems, room thermostats, and other electrical loads as needed. The striking feature is its compact design with three ceiling mounting options: Depending on the particular room situation, the unit may be installed in a false ceiling, on the surface, or in a commercial flush wall box.

# Three mounting types

## FALSE CEILING

The most discreet installation type is clip-on mounting in a false ceiling. The spring clips ensure reliable fixing of the unit, and only the lens and the narrow design ring can be seen from below.



## FLUSH MOUNTING

Flush-mounted installation of the presence detector mini or the brightness sensor is carried out by means of a separate flush mounting set in an off-the-shelf DIN 49073 flush wall box.



## SURFACE MOUNTING

The third type of ceiling installation is the surface-mounted option. JUNG also provides a separate set for this that also includes a bezel as well as a surface cap for harmonious appearance.



## BRIGHTNESS SENSOR

The KNX brightness controller with integrated brightness sensor is structurally identical to the Presence Detector Mini. This performs the interior lighting control depending on the amount of daylight present. This has the same installation options as for the Presence Detector Mini. The brightness sensor with its harmonious proportions and the „invisible“ adjustment elements has an unobtrusive design.

 Protection level IP 44 ensured



Ref.-no.

**Presence detector mini  
with integrated BCU**

ETS product family: Physical sensors  
Product type: Movement

**Standard**

white  **3361 M WW**

**Universal**

white  **3361-1 M WW**

**Intended use**

- Requirement-oriented control of lighting, room thermostats and other electrical consumers in interior rooms
- Clamp mounting in suspended ceilings
- Ceiling mounting on fixed ceilings in flush-mounted box according to DIN 49073 (with flush mounting set, ref.-no.: PMM-UP-SET-WW) or in surface-mounted housing (surface mounting set, ref.-no.: PMM-AP-SET-WW)

**Product characteristics**

- Integrated bus coupling unit
- 3 PIR sensors
- Detection field 360°
- Integrated brightness sensor
- Deployed as presence detector, motion detector, or for alert operation
- Output functions: Switching, staircase function, switching with forced position, value transmitter, light scene extension, operating mode setting for room temperature controller
- Detection area extendible by parallel switching of several devices as main unit or extension unit
- Manual sensitivity adjustment
- Status LED: Flashes during motion detection; depending on programming in normal operation or only during the walking test mode

**Additional characteristics of "Universal" version:**

- Manual operation with IR remote control possible (ref.-no.: KNX PM FB IR)
- 5 function blocks for motion or presence detection each with 2 outputs
- Function blocks switchable, e.g. for day/night operation
- PIR sensors can be evaluated separately
- Brightness sensor function with 3 limiting values
- Light control with max. 3 channels, setpoint shift in operation, separate configuration of dimming-up, control and dimming-down phase
- Light control can be combined with presence detector function

**Presence detector function:**

- Detection of the smallest motions e.g. at a workplace for detecting the presence of persons
- Switch on: Motion detection and brightness threshold not reached
- Switch off: No motion in the detection field and shut-off delay elapsed or brightness threshold exceeded

**Motion detector function:**

- Motion detection for passageways in buildings
- Switch on: Motion detection and brightness threshold not reached
- Switch off: No motion in the detection field and shut-off delay elapsed

After reacting and switching on, the motion detection works independently of the brightness.

**Signalling mode:**

- Brightness-independent detection of motions in the detection field
- Switch on: After detection of an adjustable number of motions within the set monitoring period
- Switch off: No persons in the detection field and shut-off delay elapsed

**Technical data ref.-no. 3361 M WW and 3361-1 M WW**

Rated voltage KNX:	DC 21 ... 32 V SELV
Current consumption KNX:	max. 10 mA
Connection bus:	terminal
Protection class:	III
Ambient temperature:	-25 ... +55 °C
Storage/transport temperature:	-25 ... +70 °C
Relative humidity:	10 ... 100 %
	(no condensation)
Protection level:	IP 44
Ceiling cut-out (Ø x D):	44 x 35 mm
Dimensions (Ø x H):	53.5 x 38 mm
	(with design ring)
Max. thickness of the suspended ceiling:	approx. 25 mm
Installation depth:	min. 35 mm
Distance between concrete ceiling and suspended ceiling:	min. 20 mm
Design ring Ø inside:	35.6 mm
Design ring Ø outside:	53.5 mm
Profile height design ring:	1.8 mm
Profile height lens:	5.5 mm
Motion detection	
Detection angle:	360°
Range:	Ø approx. 12 m
	(mounting height 3 m)
Brightness sensor	
Measuring range:	10 ... 2000 lx
Accuracy (≤ 80 lx):	± 10 lx
Accuracy (> 80 lx):	± 5 %



**IP** Protection level IP 44 ensured



Ref.-no.

### IR remote control

for KNX presence detector mini universal ref.-no.: 3361-1 M ..

**KNX PM FB IR**

Battery operation with one included lithium button cell (CR 2025)

### Brightness controller mini with integrated BCU

ETS-Produktfamilie: Phys. Sensoren

Produkttyp: Helligkeit

**IP** **2096 LUX**

#### Intended use

- Measurement and control of lighting in interior areas
- Installation in false ceilings
- Ceiling installation in appliance box according to DIN 49073 with flush mounting set (ref.-no.: PMM-UP-SET-WW)
- Surface-mounted ceiling installation with surface mounting set (ref.-no.: PMM-AP-SET-WW)

#### Product characteristics

- Integrated bus coupling unit
- Integrated brightness sensor
- Brightness sensor function with 3 limiting values
- Light control with max. 3 channels, setpoint shift in operation, separate configuration of dimming-up, control and dimming-down phase
- On-off control possible for switch actuators
- Power supply via bus voltage

#### Technical data

Rated voltage KNX:	DC 21 ... 32 V SELV
Current consumption KNX:	max. 10 mA
Connection bus:	terminal
Protection class:	III
Ambient temperature:	-25 ... +55 °C
Storage/transport temperature:	-25 ... +70 °C
Relative humidity:	10 ... 100 % (no condensation)
Protection level:	IP 44
Ceiling cut-out (Ø x D):	44 x 35 mm
Dimensions (Ø x H):	53.5 x 38 mm (with design ring)
Max. thickness of the suspended ceiling:	approx. 25 mm
Installation depth:	min. 35 mm
Distance between concrete ceiling and suspended ceiling:	min. 20 mm
Design ring Ø inside:	35.6 mm
Design ring Ø outside:	53.5 mm
Profile height design ring:	1.8 mm
Profile height lens:	5.5 mm
Brightness measurement	
Measuring range:	10 ... 2000 lx
Accuracy (> 80 lx):	± 5 %
Accuracy (≤ 80 lx):	± 10 lx

Ref.-no.

**Flush mounting set**

for ceiling installation of KNX presence detector mini (ref.-no.: 3361 M WW, 3361-1 M WW)  
and KNX brightness controller mini (ref.-no.: 2096 LUX)  
to be installed into 68 mm flush box  
Design ring  $\varnothing$  inside: 35.6 mm,  $\varnothing$  outside: 80 mm  
Profile height design ring: 3 mm  
Profile height lens: 6.6 mm

**PMM-UP-SET-WW****Surface mounting set**

for ceiling installation of KNX presence detector mini (ref.-no.: 3361 M WW, 3361-1 M WW)  
and KNX brightness controller mini (ref.-no.: 2096 LUX)  
Dimensions ( $\varnothing$  x H): 80 / 83 x 49 mm (incl. design ring)  
Design ring  $\varnothing$  inside: 35.6 mm,  $\varnothing$  outside: 80 mm

**PMM-AP-SET-WW**

# Presence detector / ceiling observer



This presence detector / ceiling observer is reliable, even when great height is a problem. When installed in heights of up to 5 m, the unit registers everything that is moving within a diameter of approx. 20 m. The detection angle of 360° may be divided into three sensor segments of 120° each that may be enabled individually.

### DETECTION FIELD

The presence detector / ceiling observer has an especially homogeneous detection area of around 20 m (when installed at a height of 5 m). This allows precise motion detection in large rooms as well.

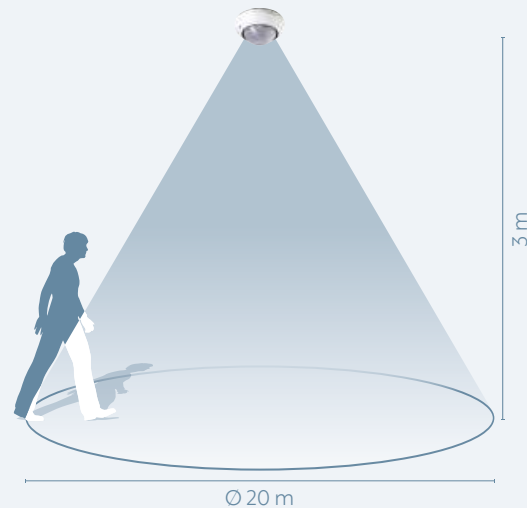

### RANGE

The 360° detection angle can be divided into three separate 120° portions that can be enabled individually by the relevant one of the three PIR sensors.

These sensors can also be evaluated individually by software so that the “viewing direction” of the sensors can be modified using parameters (Universal version).

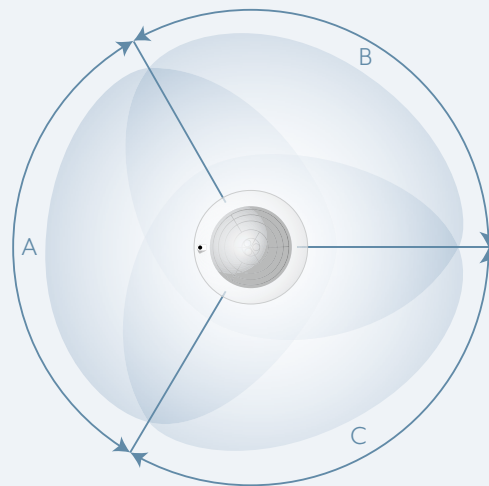

There are Standard and Universal versions of the presence detector / ceiling observer. In addition to presence-dependent constant light regulation, the Universal model also has five function blocks that operate independently of each other and to which the three PIR sensors can be assigned. Each functional block may be configured as desired for the presence detector, ceiling observer, or signalling applications.

For example, using KNX commands, the blocks can be switched to the respective required application, depending on the time of day and use. The unit may be optionally set up and operated using an IR remote control.

Tip for installation in gymnasiums: The presence detector may optionally be fitted with a protective basket made of solid steel. Thus, it will be effectively protected against damage by thrown balls.



Ref.-no.

### Presence detector with integrated BCU

ETS product family: Physical sensors  
Product type: Movement

#### Standard

white	<b>3361 WW</b>
aluminium (lacquered)	<b>3361 AL</b>

#### Universal

white	<b>3361-1 WW</b>
aluminium (lacquered)	<b>3361-1 AL</b>

#### Intended use

- Requirement-oriented control of lighting, room thermostats and other electrical loads in interior rooms
- Ceiling mounting on fixed ceilings in appliance box according to DIN 49073 or surface-mounted housing  
ref.-no.: PM-KAPPE-1 or PM-KAPPE AL-1

#### Product characteristics

- Integrated bus coupling unit • 3 PIR sensors • Detection field 360° (3 x 120°) • Integrated brightness sensor
- Deployed as presence detector, motion detector, or for alert operation • Output functions: Switching, staircase function, switching with forced position, value transmitter, light scene extension, operating mode setting for room temperature controller • Detection area extendible by parallel switching of several devices as main unit or extension unit • Manual sensitivity adjustment • Status LED: Flashes during motion detection; depending on programming in normal operation or only during the walking test mode

#### Additional characteristics of "Universal" version:

- Manual operation with IR remote control possible (ref.-no.: KNX PM FB IR) • 5 function blocks for motion or presence detection each with 2 outputs • Function blocks switchable, e.g. for day/night operation • PIR sensors can be evaluated separately • Brightness sensor function with 3 limiting values • Light control with max. 3 channels, setpoint shift in operation, separate configuration of dimming-up, control and dimming-down phase • Light control can be combined with presence detector function

#### Presence detector function:

- Detection of the smallest motions e.g. at a workplace for detecting the presence of persons • Switch on: Motion detection and brightness threshold not reached • Switch off: No motion in the detection field and shut-off delay elapsed or brightness threshold exceeded

#### Motion detector function:

- Motion detection for passageways in buildings • Switch on: Motion detection and brightness threshold not reached • Switch off: No motion in the detection field and shut-off delay elapsed – After reacting and switching on, the motion detection works independently of the brightness.

#### Signalling mode:

- Brightness-independent detection of motions in the detection field • Switch on: After detection of an adjustable number of motions within the set monitoring period • Switch off: No persons in the detection field and shut-off delay elapsed

#### Technical data

Rated voltage KNX:	DC 21 ... 32 V SELV
Current consumption KNX:	max. 12.5 mA
Connection bus:	terminal
Ambient temperature:	-5 ... +45 °C
Storage/transport temperature:	-25 ... +70 °C
Relative humidity:	5 ... 93 % (no condensation)
Protection class:	III
Detection angle:	360°
Range:	Ø approx. 20 m (mounting height 3 m)
Brightness sensor	
Measuring range:	0 ... 2000 lx
Detection range:	Ø 2 m

	Ref.-no.
<b>Surface-mounted housing</b>	
for ceiling installation (surface-mounted) of KNX presence detectors	
ref. no.: 3361 WW, 3361 AL, 3361-1 WW, 3361-1 AL	
white	<b>PM-KAPPE-1</b>
aluminium (lacquered)	<b>PM-KAPPE AL-1</b>
Dimensions: diameter 103 mm, height: 19 mm	
<b>IR remote control</b>	
for KNX presence detector universal ref.-no.: 3361-1 ..	
	<b>KNX PM FB IR</b>
Battery operation with one included lithium button cell (CR 2025)	
<b>Protection cage</b>	
for KNX presence detector ref.-no.: 3361..	
white	<b>SK 180-90 WW</b>
varnished steel with plastic coating	
dimensions (Ø x H): approx. 180 x 90 mm	







**KNX AUTOMATIC SWITCH**  
in the 1.10 m and 2.20 m versions

# Automatic switch

**KNX AUTOMATIC SWITCH 1.10 M**

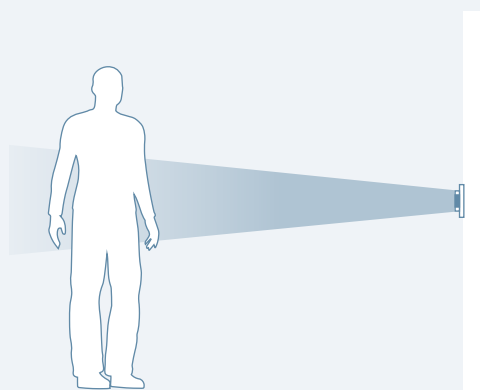

**KNX AUTOMATIC SWITCH 2.20 M**

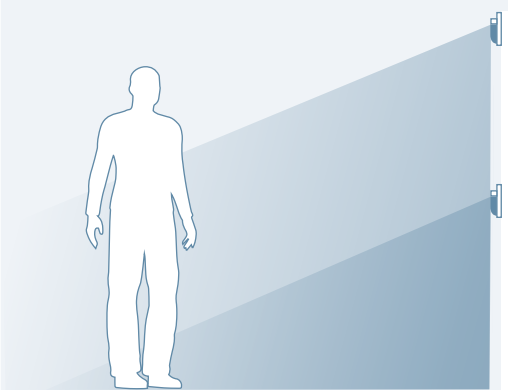

## IMPROVED DETECTION CHARACTERISTICS, EXTENDED FUNCTIONALITY

The 180° detection range is monitored by two PIR sensors that can be used individually or together. In this way, difficult room situations can also be optimally covered, such as small rooms or stairways. In this respect they are to be used as movement detectors in corridors and passages. On the other hand, as “observer with switch-off brightness”, they are outstanding in use, for example, in offices.

The software for the automatic switch is matched with respect to its important parameters to the JUNG KNX presence detectors, which allows simple initial start-up.

New performance characteristic: the integrated temperature sensor. The actual room temperature is measured with this. It can be reported to various KNX devices for heating regulation and air conditioning.

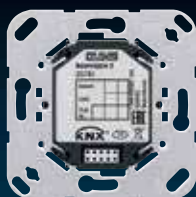

Ref.-no.

### Bus coupling unit 3

screw fixing only, without claws

**2073 U**

### Intended use

- Coupling of automatic switches (ref.-no.: ..3181.., ..3281..) to KNX systems
- Installation in flush-box according to DIN 49073

### Technical data

KNX medium:	TP 256
Rated voltage KNX:	DC 21 ... 32 V SELV
Ambient temperature:	-25 ... +55 °C
Storage/transport temperature:	-25 ... +70 °C
Protection class:	III

### Automatic switch 1.1 m

#### for bus coupling unit 3 ref.-no.: 2073 U

ETS product family: Physical sensors

Product type: Movement

### Intended use

- Requirement-oriented control of lighting and other electrical loads in interior rooms
- Mounting on bus coupling unit 3 (ref.-no.: 2073 U)

### Product characteristics

- Automatic switching of lighting depending on the thermal movement and ambient brightness
- 2 PIR sensors
- Detection range 180°
- Integrated brightness sensor
- Switch-off brightness can be set
- Output functions: switching, value transmitter, light scene extension, staircase function, switching with forced position, operating mode setting for room temperature controller
- Extension of the detection area by way of operating several devices as main unit or extension unit
- Sensitivity can be set manually
- Status LEDs
- Manual switching on the device
- Up to half of the detection area can be screened off (cover or parameter setting)

### Additional characteristics of "Universal" version:

- Manual operation with IR remote control possible (ref.-no.: KNX PM FB IR)
- 5 function blocks for motion detection each with 2 outputs
- Function blocks switchable, e.g. for day/night operation
- Brightness sensor function with 3 limiting values
- Alarm message in case the device is removed from the bus coupling unit
- Temperature measurement

### for AS and A ranges

### Standard

#### Thermoplastic (breakproof) high-gloss

ivory	<b>A 3181</b>
white	<b>A 3181 WW</b>
black	<b>A 3181 SW</b>

#### Thermoplastic (breakproof) lacquered

aluminium	<b>A 3181 AL</b>
champagne	<b>A 3181 CH</b>
mocha	<b>A 3181 MO</b>
matt anthracite	<b>A 3181 ANM</b>

	Ref.-no.
<b>Universal</b>	
<b>Thermoplastic (breakproof) high-gloss</b>	
ivory	A 3181-1
white	A 3181-1 WW
black	A 3181-1 SW
<b>Thermoplastic (breakproof) lacquered</b>	
aluminium	A 3181-1 AL
champagne	A 3181-1 CH
mocha	A 3181-1 MO
matt anthracite	A 3181-1 ANM
<b>for CD range</b>	
<b>Standard</b>	
<b>Thermoplastic (breakproof) high-gloss</b>	
ivory	CD 3181
white	CD 3181 WW
grey	CD 3181 GR
light grey	CD 3181 LG
black	CD 3181 SW
<b>Universal</b>	
<b>Thermoplastic (breakproof) high-gloss</b>	
ivory	CD 3181-1
white	CD 3181-1 WW
grey	CD 3181-1 GR
light grey	CD 3181-1 LG
black	CD 3181-1 SW
<b>for LS range</b>	
<b>Standard</b>	
<b>Thermoplastic (breakproof) high-gloss</b>	
ivory	LS 3181
white	LS 3181 WW
light grey	LS 3181 LG
black	LS 3181 SW
<b>metal versions</b>	
aluminium (lacquered)	AL 3181
stainless steel (lacquered)	ES 3181
anthracite (lacquered)	AL 3181 AN
dark (lacquered)	AL 3181 D
classic brass (lacquered)	ME 3181 C
antique brass (lacquered)	ME 3181 AT
<b>Universal</b>	
<b>Thermoplastic (breakproof) high-gloss</b>	
ivory	LS 3181-1
white	LS 3181-1 WW
light grey	LS 3181-1 LG
black	LS 3181-1 SW
<b>metal versions</b>	
aluminium (lacquered)	AL 3181-1
stainless steel (lacquered)	ES 3181-1
anthracite (lacquered)	AL 3181-1 AN
dark (lacquered)	AL 3181-1 D
classic brass (lacquered)	ME 3181-1 C
antique brass (lacquered)	ME 3181-1 AT



Ref.-no.

**Automatic switch 2.2 m  
for bus coupling unit 3 ref.-no.: 2073 U**

ETS product family: Physical sensors

Product type: Movement

**Intended use**

- Requirement-oriented control of lighting and other electrical loads
- Mounting on bus coupling unit 3 (ref.-no.: 2073 U)

**Product characteristics**

- Automatic switching of lighting depending on the thermal movement and ambient brightness
- 2 PIR sensors
- Detection range 180°
- Integrated brightness sensor
- Switch-off brightness can be set
- Output functions: switching, value transmitter, light scene extension, staircase function, switching with forced position, operating mode setting for room temperature controller
- Extension of the detection area by way of operating several devices as main unit or extension unit
- Sensitivity can be set manually
- Status LEDs
- Manual switching on the device

**Additional characteristics of "Universal" version:**

- Manual operation with IR remote control possible (ref.-no.: KNX PM FB IR)
- Up to half of the detection area can be screened off (parameter setting)
- 5 function blocks for motion detection each with 2 outputs
- Function blocks switchable, e.g. for day/night operation
- Brightness sensor function with 3 limiting values
- Alarm message in case the device is removed from the bus coupling unit
- Temperature measurement

**for AS and A ranges**



**Standard**

**Thermoplastic (breakproof) high-gloss**

ivory	<b>A 3281</b>
white	<b>A 3281 WW</b>
black	<b>A 3281 SW</b>

**Thermoplastic (breakproof) lacquered**

aluminium	<b>A 3281 AL</b>
champagne	<b>A 3281 CH</b>
mocha	<b>A 3281 MO</b>
matt anthracite	<b>A 3281 ANM</b>



**Universal**

**Thermoplastic (breakproof) high-gloss**

ivory	<b>A 3281-1</b>
white	<b>A 3281-1 WW</b>
black	<b>A 3281-1 SW</b>

**Thermoplastic (breakproof) lacquered**

aluminium	<b>A 3281-1 AL</b>
champagne	<b>A 3281-1 CH</b>
mocha	<b>A 3281-1 MO</b>
matt anthracite	<b>A 3281-1 ANM</b>

	Ref.-no.
<b>for CD range</b>	
<b>Standard</b>	
<b>Thermoplastic (breakproof) high-gloss</b>	
ivory	CD 3281
white	CD 3281 WW
grey	CD 3281 GR
light grey	CD 3281 LG
black	CD 3281 SW
<b>Universal</b>	
<b>Thermoplastic (breakproof) high-gloss</b>	
ivory	CD 3281-1
white	CD 3281-1 WW
grey	CD 3281-1 GR
light grey	CD 3281-1 LG
black	CD 3281-1 SW
<b>for LS range</b>	
<b>Standard</b>	
<b>Thermoplastic (breakproof) high-gloss</b>	
ivory	LS 3281
white	LS 3281 WW
light grey	LS 3281 LG
black	LS 3281 SW
<b>metal versions</b>	
aluminium (lacquered)	AL 3281
stainless steel (lacquered)	ES 3281
anthracite (lacquered)	AL 3281 AN
dark (lacquered)	AL 3281 D
classic brass (lacquered)	ME 3281 C
antique brass (lacquered)	ME 3281 AT
<b>Universal</b>	
<b>Thermoplastic (breakproof) high-gloss</b>	
ivory	LS 3281-1
white	LS 3281-1 WW
light grey	LS 3281-1 LG
black	LS 3281-1 SW
<b>metal versions</b>	
aluminium (lacquered)	AL 3281-1
stainless steel (lacquered)	ES 3281-1
anthracite (lacquered)	AL 3281-1 AN
dark (lacquered)	AL 3281-1 D
classic brass (lacquered)	ME 3281-1 C
antique brass (lacquered)	ME 3281-1 AT







**KNX ROOM THERMOSTAT FAN COIL**

Consistent JUNG design also in the KNX temperature and ventilation control: The different room thermostats provide a healthy room climate in private and commercial buildings. Well thought out operating concepts support the intuitive handling in each case.

# Room thermostat

## ROOM TEMPERATURE CONTROLLER

Standalone solution for heating and cooling for the residential and commercial areas. It is also possible to interrogate conventional push-buttons and/or window and door contacts as well as dew/condensation and leak sensors.



## ROOM AUTOSTAT

Has no setting wheel and thus cannot be manipulated and therefore ideal for use in public buildings; the KNX room autostat with integrated push-button interface, 4-gang for convenient temperature control.



## CLIMATE SENSOR

For automated ventilation applications and/or for temperature control. Also possible: Interrogation of conventional push-buttons and/or window and door contacts as well as dew/condensation and leak sensors.



## ROOM TEMPERATURE CONTROLLER F 50

Controller for heating/cooling with integrated fan coil actuation. With variable display and operation options; self-explanatory symbols and coloured status and operation LEDs optimise the operation.

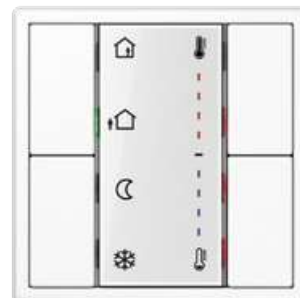

## ROOM THERMOSTAT FAN COIL

Controller for temperature and ventilation, mainly for the hotel business. Intuitive operating concept using capacitive sensor push-buttons. Clear display and unambiguous symbols make the selection from four operating modes easy.



# Room Temperature Controller F 50 options

## OFFICE APPLICATION EXAMPLES

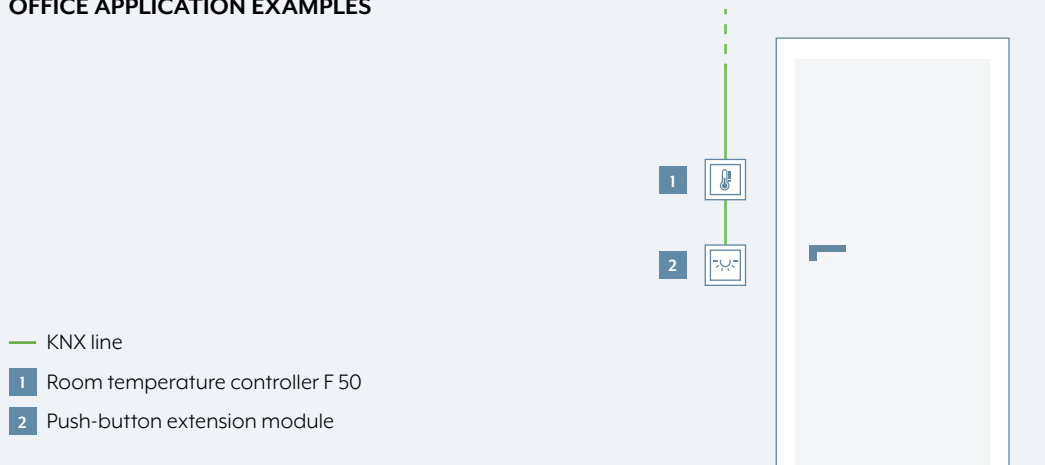

## OFFICE CORRIDOR

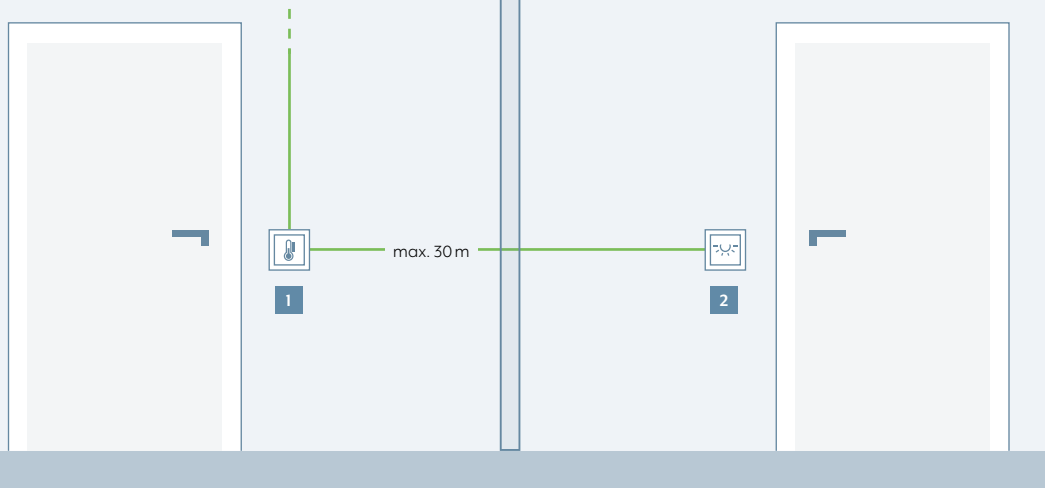

## PUSH-BUTTON EXTENSION MODULE FOR ROOM TEMPERATURE CONTROLLER F 50

The functions can be extended by connecting the 1- to 4-gang push-button extension module, while at the same time minimising the load on the bus. Particularly the option for installation of the extension module at a distance of up to 30 m provides more flexibility.

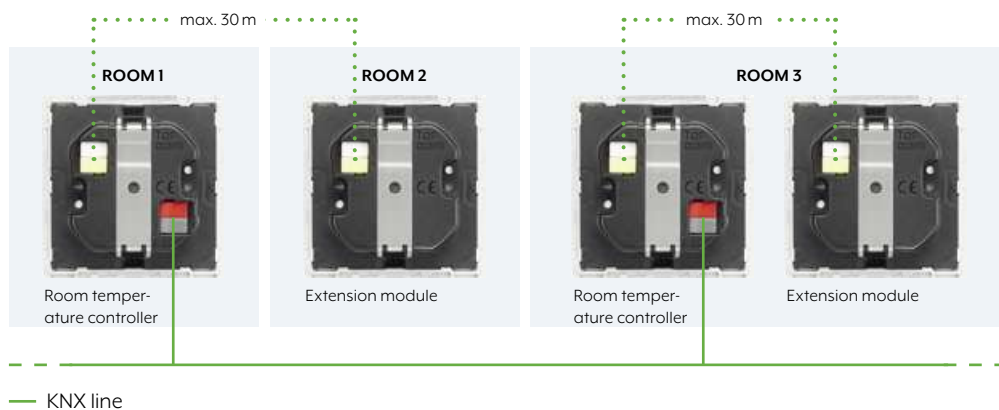

Display and adjustment of the operating mode The temperature mode is selected as required using the "Comfort", "Standby", "Night Operation" and "Frost Protection" operating modes.

### PRESENCE BUTTON

The user can decide between presence and absence with the Presence button. The appropriate symbols and coloured LEDs display the current status.

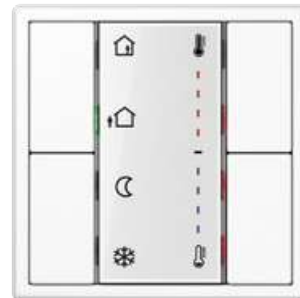

### STANDBY/NIGHT OPERATION

At times of absence a choice between the 'frost protection' and 'night reduction' operation modes can be made. Coloured LEDs next to the symbols indicate the relevant mode.

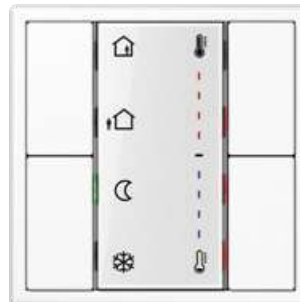

### MOVE BLINDS/SHUTTERS

Push-button sensor functions can be individually parametrised. Here, the operating mode changeover is changed to the "move blinds/shutters" push-button function.



### SWITCH/DIM

The "switch/dim" push-button functions on one side have been combined with temperature setpoint shift on the other side for this parametrisation.



Ref.-no.

**Temperature controller fan coil****Intended use**

- Sensor module for operating electrical fan coil units in KNX installations
- Measurement and feedback control of the room temperature
- Installation in flush-box according to DIN 49073 (recommendation: deep box)

**Product characteristics**

- Real glass front panel
- 8 capacitive sensor buttons
- Internal temperature sensor
- External temperature sensor can be evaluated
- Control of fan coil units
- Heating and/or cooling mode
- Suitable for 2-pipe or 4-pipe systems
- Up to 3 fan speeds can be controlled
- Room temperature controller function
- Preselection of the current energy level either through the option of 4 operating modes in accordance with KNX standard or of 5 temperature profiles for use in hotels or similar sites
- Display for indication of temperature (°C or °F), fan speed, operating mode/profile
- 1 operating level and 2 menu levels
- Menu levels blockable
- 1 status LED (red/green/blue)
- Brightness and contrast adjustable
- Duration of the display illumination up to 120 seconds
- Operation as extension unit for temperature controller possible
- Integrated bus coupling unit

**Technical data**

KNX medium:	TP 256
Rated voltage KNX:	DC 21 ... 32 V SELV
Current consumption KNX:	8 ... 17.5 mA
Protection class:	III
Ambient temperature:	-5 ... +45 °C
Storage/transport temperature:	-20 ... +70 °C

**for AS and A ranges**

white	<b>TRD A 5248 WW</b>
black	<b>TRD A 5248 SW</b>

**for LS range**

white	<b>TRD LS 9248 WW</b>
black	<b>TRD LS 9248 SW</b>



Ref.-no.

## Room temperature controller module 2-gang

including transparent cover and inlay with symbols

### Intended use

- Single-room temperature control in KNX installations
- Operation of loads, e.g. light on/off, dimming, blinds up/down, recalling and saving light scenes, etc.
- Installation in wall box according to DIN 49073

### Product characteristics

All buttons can be assigned with push-button sensor functions or functions for controller operation.

- Measurement of the room temperature
- Room temperature control with setpoint value specification
- Extension for room temperature controller
- Push-button functions switching, dimming, blind control, value transmitter, scene recall, etc.
- One or two functions per button
- Completion with cover kit 2-gang
- Illuminable inscription field
- Two red status LEDs per button – red, green or blue adjustable
- One operation LED as an orientation light and to indicate the programming status – red, green or blue adjustable
- Brightness of status LED, operation LED and labelling field adjustable; switchable while in operation, e.g. during the night
- Disabling function: Disable or function switch-over of all or of individual push-button functions
- Alarm function, optionally with confirmation by pressing any button
- Energy saving mode (for operation without controller function)
- Integrated bus coupling unit
- Connection for a push-button extension module, for extension with up to eight additional buttons

### for AS and A ranges

for cover kit 2-gang, complete, ref.-no.: A 502 TSA ..

**A 5178 TSM**

### for CD range

for cover kit 2-gang, complete, ref.-no.: CD 502 TSA ..

**CD 5178 TSM**

### for LS range

for cover kit 2-gang, complete, ref.-no.: ..502 TSA .. for the LS range

**LS 5178 TSM**





---

**Room temperature controller  
with integrated BCU  
with rotary knob for set point adjustment**

Only with the ETS 3.0d version or later versions the full functionality will be available.

**Intended use**

- Single-room temperature control in KNX installations
- Installation in appliance box according to DIN 49073

**Product characteristics**

- Measurement of room temperature and comparison with setpoint temperature
- Setpoint specification by selection of the operating mode
- Operating modes: Comfort, Standby, Night operation, Frost/heat protection
- Heating and cooling mode
- Heating and cooling with basic and additional step
- Setpoint adjustment
- Presence push-button
- Status LEDs

	Ref.-no.
<b>for AS and A ranges</b>	
<b>Thermoplastic (breakproof) high-gloss</b>	
ivory	<b>A 2178</b>
white	<b>A 2178 WW</b>
black	<b>A 2178 SW</b>
<b>Thermoplastic (breakproof) lacquered</b>	
aluminium	<b>A 2178 AL</b>
champagne	<b>A 2178 CH</b>
mocha	<b>A 2178 MO</b>
matt anthracite	<b>A 2178 ANM</b>
<b>for CD range</b>	
<b>Thermoplastic (breakproof) high-gloss</b>	
ivory	<b>2178</b>
white	<b>CD 2178 WW</b>
grey	<b>CD 2178 GR</b>
light grey	<b>CD 2178 LG</b>
black	<b>CD 2178 SW</b>
<b>for LS range</b>	
<b>Thermoplastic (breakproof) high-gloss</b>	
ivory	<b>LS 2178</b>
white	<b>LS 2178 WW</b>
light grey	<b>LS 2178 LG</b>
black	<b>LS 2178 SW</b>
<b>metal versions</b>	
aluminium	<b>AL 2178</b>
stainless steel	<b>ES 2178</b>
anthracite (aluminium lacquered)	<b>AL 2178 AN</b>
chrome	<b>GCR 2178</b>
classic brass	<b>ME 2178 C</b>
antique brass	<b>ME 2178 AT</b>



**Room temperature controller  
with integrated BCU  
with integrated push-button interface 4-gang  
with rotary knob for set point adjustment**

Only with the ETS 3.0d version or later versions the full functionality will be available.

**• Intended use**

- Single-room temperature control in KNX installations
- Type of loads for binary output: LED or electronic relays
- Installation in appliance box according to DIN 49073

**Product characteristics**

- Measurement of room temperature and comparison with setpoint temperature
- Setpoint specification by selection of the operating mode
- Operating modes: Comfort, Standby, Night operation, Frost/heat protection
- Heating and cooling mode
- Heating and cooling with basic and additional step
- Setpoint adjustment
- Presence push-button
- Status LEDs
- Push-button interface with four inputs or two outputs (0.8 mA) and two inputs, e.g. for window contacts, push-buttons, LEDs, etc.
- Function of the inputs: switching, dimming, shutter control, light scene extension, brightness or temperature value transmitter
- Option: External temperature sensor (accessory ref.-no.: FF 7.8) connectable to input 4

**Technical data**

Rated voltage KNX:	DC 21 ... 32 V SELV
Current consumption KNX:	max. 10 mA
Connection, KNX:	terminal
Ambient temperature:	-5 ... +45 °C
Storage/transport temperature:	-25 ... +70 °C
Output current:	0.8 mA
Inputs and outputs	
Cable type:	J-Y(St)Y 2 x 2 x 0.8 mm <sup>2</sup>
Cable length:	max. 5 m
Temperature sensor cable length:	max. 50 m

**Use deep wall box for cables with 1.5 mm<sup>2</sup>**

	Ref.-no.
<b>for AS and A ranges</b>	
<b>Thermoplastic (breakproof) high-gloss</b>	
ivory	A 2178 TS
white	A 2178 TS WW
black	A 2178 TS SW
<b>Thermoplastic (breakproof) lacquered</b>	
aluminium	A 2178 TS AL
champagne	A 2178 TS CH
mocha	A 2178 TS MO
matt anthracite	A 2178 TS ANM
<b>for CD range</b>	
<b>Thermoplastic (breakproof) high-gloss</b>	
ivory	2178 TS
white	CD 2178 TS WW
grey	CD 2178 TS GR
light grey	CD 2178 TS LG
black	CD 2178 TS SW
<b>for LS range</b>	
<b>Thermoplastic (breakproof) high-gloss</b>	
ivory	LS 2178 TS
white	LS 2178 TS WW
light grey	LS 2178 TS LG
black	LS 2178 TS SW
<b>metal versions</b>	
aluminium	AL 2178 TS
stainless steel	ES 2178 TS
anthracite (aluminium lacquered)	AL 2178 TS AN
dark (aluminium lacquered)	AL 2178 TS D
chrome	GCR 2178 TS
classic brass	ME 2178 TS C
antique brass	ME 2178 TS AT



**Room autostat  
with integrated BCU  
with integrated push-button interface 4-gang  
without rotary knob for set point adjustment**  
without any operational elements

Only with the ETS 3.0d version or later versions the full functionality will be available.

**Intended use**

- Single-room temperature control in KNX installations
- Integrated 4-gang binary input for universal use
- Installation in appliance box according to DIN 49073
- Recommended for installations in public buildings

**Product characteristics**

- Measurement of room temperature and comparison with setpoint temperature
- Setpoint specification by selection of the operating mode
- Operating modes: Comfort, Standby, Night operation, Frost/heat protection
- Heating and cooling mode
- Heating and cooling with basic and additional step
- Operation solely via the bus
- Push-button interface with four inputs or two outputs (0.8 mA) and two inputs, e.g. for window contacts, push-buttons, LEDs, etc.
- Function of the inputs: switching, dimming, shutter control, light scene extension, brightness or temperature value transmitter
- Option: External temperature sensor (accessory ref.-no.: FF 7.8) connectable to input 4

**Technical data**

Rated voltage KNX:	DC 21 ... 32 V SELV
Current consumption KNX:	max. 7.5 mA
Connection, KNX:	terminal
Ambient temperature:	-5 ... +45 °C
Storage/transport temperature:	-25 ... +70 °C
Output current:	0.8 mA
Inputs and outputs	
Cable type:	J-Y(St)Y 2 x 2 x 0.8 mm <sup>2</sup>
Cable length:	max. 5 m
Temperature sensor cable length:	max. 50 m
	<b>Use deep wall box for cables with 1.5 mm<sup>2</sup></b>

	Ref.-no.
<b>for AS and A ranges</b>	
<b>Duroplastic (scratch-proof) glossy</b>	
ivory	A 2178 ORTS
white	A 2178 ORTS WW
black	A 2178 ORTS SW
<b>Duroplastic lacquered</b>	
aluminium	A 2178 ORTS AL
champagne	A 2178 ORTS CH
mocha	A 2178 ORTS MO
<b>Thermoplastic (breakproof) high-gloss</b>	
white	A 2178 BF ORTS WW
black	A 2178 BF ORTS SW
<b>Thermoplastic (breakproof) lacquered</b>	
matt anthracite	A 2178 BF ORTS ANM
<b>for CD range</b>	
<b>Duroplastic (scratch-proof) glossy</b>	
ivory	2178 ORTS
white	CD 2178 ORTS WW
grey	CD 2178 ORTS GR
light grey	CD 2178 ORTS LG
black	CD 2178 ORTS SW
<b>for LS range</b>	
<b>Duroplastic (scratch-proof) glossy</b>	
ivory	LS 2178 ORTS
white	LS 2178 ORTS WW
light grey	LS 2178 ORTS LG
black	LS 2178 ORTS SW
<b>metal versions</b>	
aluminium	AL 2178 ORTS
stainless steel	ES 2178 ORTS
anthracite (aluminium lacquered)	AL 2178 ORTS AN
chrome	GCR 2178 ORTS
classic brass	ME 2178 ORTS C
antique brass	ME 2178 ORTS AT





**CO<sub>2</sub> multi-sensor  
with integrated BCU  
with humidity sensor and room temperature controller  
with integrated push-button interface 2-gang**

**Intended use**

- Measurement of CO<sub>2</sub> concentration, relative air humidity and air temperature
- Output of the measured values as telegram to the bus, e.g. for controlling fans or window drives via KNX telegrams
- Single-room temperature control in KNX installations
- Installation in appliance box according to DIN 49073

**Product characteristics**

- Limit value monitoring for CO<sub>2</sub> concentration (max. 4 threshold values) and air humidity (max. 2 threshold values)
- Dew point alarm e.g. for cooling blankets and conservatories, to avoid mould formation
- Two binary inputs for connection of floating contacts e.g. buttons, switches, window contacts
- Logic gates for simple gating functions

**Technical data**

Rated voltage KNX:	DC 21 ... 32 V SELV
Current consumption KNX:	typical 12.5 mA max. 25 mA (4 s/15 s as a cycle)
Connection, KNX:	terminal
Protection class:	III
Ambient temperature:	-5 ... +45 °C
Binary inputs	
Cable length:	max. 5 m
Cable type:	J-Y(St)Y 2 x 2 x 0.8 mm <sup>2</sup>
CO <sub>2</sub> sensor	
Measuring range:	0 ... 2000 ppm
Humidity sensor	
Measuring range:	10 ... 95 % relative humidity (r. h.)
Temperature sensor	
Measuring range:	-5 ... +45 °C

	Ref.-no.
<b>for AS and A ranges</b>	
<b>Duroplastic (scratch-proof) glossy</b>	
ivory	CO2 A 2178
white	CO2 A 2178 WW
black	CO2 A 2178 SW
<b>Duroplastic lacquered</b>	
aluminium	CO2 A 2178 AL
champagne	CO2 A 2178 CH
mocha	CO2 A 2178 MO
<b>Thermoplastic (breakproof) high-gloss</b>	
white	CO2 A 2178 BF WW
black	CO2 A 2178 BF SW
<b>Thermoplastic (breakproof) lacquered</b>	
matt anthracite	CO2 A 2178 BF ANM
<b>for CD range</b>	
<b>Duroplastic (scratch-proof) glossy</b>	
ivory	CO2 CD 2178
white	CO2 CD 2178 WW
grey	CO2 CD 2178 GR
light grey	CO2 CD 2178 LG
black	CO2 CD 2178 SW
<b>for LS range</b>	
<b>Duroplastic (scratch-proof) glossy</b>	
ivory	CO2 LS 2178
white	CO2 LS 2178 WW
light grey	CO2 LS 2178 LG
black	CO2 LS 2178 SW
<b>metal versions</b>	
aluminium	CO2 AL 2178
stainless steel	CO2 ES 2178
anthracite (aluminium lacquered)	CO2 AL 2178 AN
dark (aluminium lacquered)	CO2 AL 2178 D
chrome	CO2 GCR 2178
classic brass	CO2 ME 2178 C
antique brass	CO2 ME 2178 AT



# System design

Overview: The example design of a KNX installation with the individual system devices – including the various options of transmission paths and types of programming access.

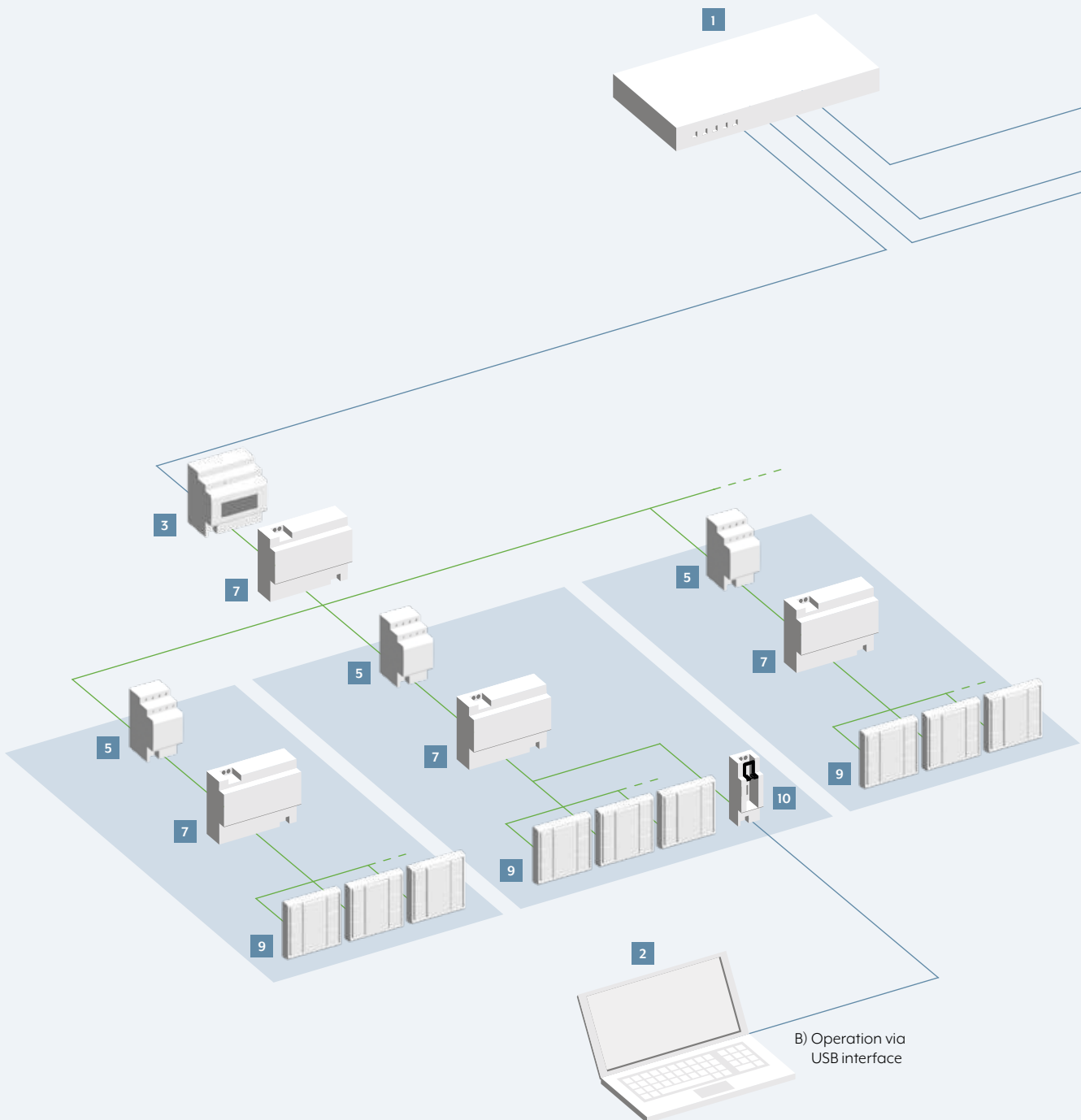

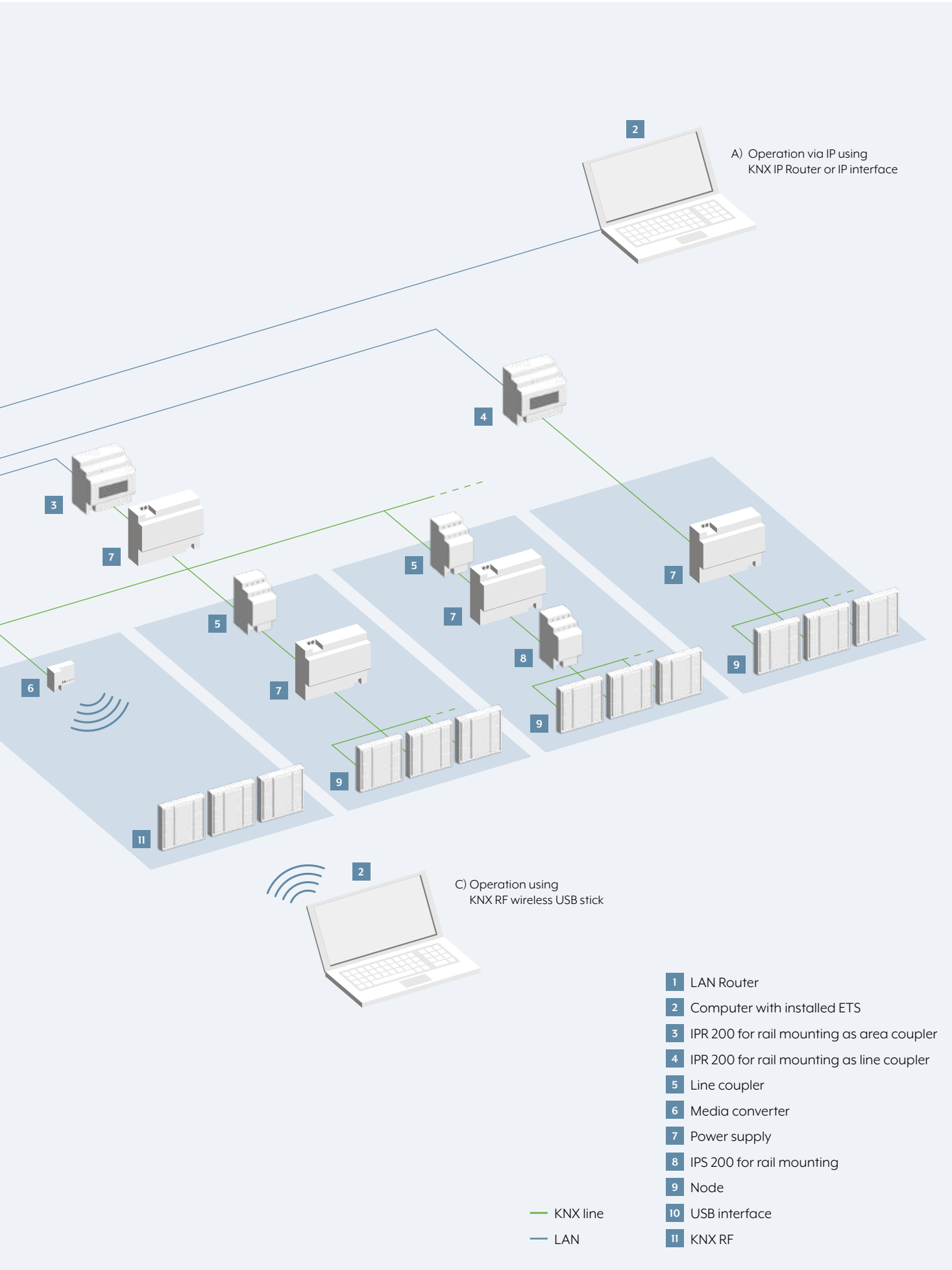

Ref.-no.

**Power supplies****Intended use**

- Supplying KNX devices with bus voltage
- Supplying devices with direct current
- Mounting on DIN rail according to EN 60715 in distribution boxes

**Product characteristics**

- Output with integrated choke for supplying KNX bus lines
- Output DC 30 V for supplying additional devices
- Nominal current can be subdivided to outputs as desired
- Reset button
- Short-circuit proof
- Overvoltage proof
- No-load protection
- Suitable for operation in systems with emergency power supply
- Potential-free signal contact for operating and diagnostic message
- With identical power supply parallel switchable  
(until the maximum short-circuit current is reached)

**Power supply, 160 mA**

Rail mounting device, 4 rail units

ETS product family: System components

Product type: Power supply

**20160 REG****Technical data**

Rated voltage AC:	AC 180 ... 264 V ~
Mains frequency:	50 / 60 Hz max. 1.5 W
Efficiency:	approx. 76 %
Rated voltage DC:	DC 240 ... 250 V
KNX	
KNX medium:	TP 256
Bus output voltage:	DC 28 ... 31 V SELV
Output current:	160 mA (all outputs)
Short-circuit current:	max. 1 A
Parallel operation with additional power supply:	yes
Signal output	
Switching voltage AC:	AC 12 ... 230 V ~
Switching voltage DC:	DC 2 ... 30 V
Switching current:	5 mA ... 2 A
Ambient temperature:	-5 ... +45 °C
Storage/transport temperature:	-25 ... +75 °C
Relative humidity:	max. 93 % (no condensation)
Mounting width:	72 mm (4 rail units)

Ref.-no.

**Power supply, 320 mA**

Rail mounting device, 4 rail units

ETS product family: System components

Product type: Power supply

**20320 REG****Technical data**

Rated voltage AC:	AC 180 ... 264 V ~
Mains frequency:	50 / 60 Hz
	max. 1.8 W
Efficiency:	approx. 84 %
Rated voltage DC:	DC 240 ... 250 V
KNX	
KNX medium:	TP 256
Bus output voltage:	DC 28 ... 31 V SELV
Output current:	320 mA (all outputs)
Short-circuit current:	max. 1 A
Parallel operation with additional power supply:	yes
Signal output	
Switching voltage AC:	AC 12 ... 230 V ~
Switching voltage DC:	DC 2 ... 30 V
Switching current:	5 mA ... 2 A
Ambient temperature:	-5 ... +45 °C
Storage/transport temperature:	-25 ... +75 °C
Relative humidity:	max. 93 % (no condensation)
Mounting width:	72 mm (4 rail units)

**Power supply, 640 mA**

Rail mounting device, 4 rail units

ETS product family: System components

Product type: Power supply

**20640 REG****Technical data**

Rated voltage AC:	AC 180 ... 264 V ~
Mains frequency:	50 / 60 Hz
	max. 2.9 W
Efficiency:	approx. 87 %
Rated voltage DC:	DC 240 ... 250 V
KNX	
KNX medium:	TP 256
Bus output voltage:	DC 28 ... 31 V SELV
Output current:	640 mA (all outputs)
Short-circuit current:	max. 1.5 A
Parallel operation with additional power supply:	yes
Signal output	
Switching voltage AC:	AC 12 ... 230 V ~
Switching voltage DC:	DC 2 ... 30 V
Switching current:	5 mA ... 2 A
Ambient temperature:	-5 ... +45 °C
Storage/transport temperature:	-25 ... +75 °C
Relative humidity:	max. 93 % (no condensation)
Mounting width:	72 mm (4 rail units)





Ref.-no.

**Power supply, 1280 mA**

Rail mounting device, 6 rail units  
 ETS product family: System components  
 Product type: Power supply

**21280 REG****Technical data**

Rated voltage AC:	AC 180 ... 264 V ~
Mains frequency:	50 / 60 Hz max. 6.4 W
Efficiency:	approx. 86 %
Rated voltage DC:	DC 240 ... 250 V
KNX	
KNX medium:	TP 256
Bus output voltage:	DC 28 ... 31 V SELV
Output current:	1280 mA (all outputs)
Short-circuit current:	max. 3 A
Parallel operation with additional power supply:	no
Signal output	
Switching voltage AC:	AC 12 ... 230 V ~
Switching voltage DC:	DC 2 ... 30 V
Switching current:	5 mA ... 2 A
Ambient temperature:	-5 ... +45 °C
Storage/transport temperature:	-25 ... +75 °C
Relative humidity:	max. 93 % (no condensation)
Mounting width:	108 mm (6 rail units)



Ref.-no.

**Uninterruptible KNX power supply 640 mA  
with integrated choke**

Rail mounting device, 8 rail units

ETS product family: System components

Product type: Power supply

**USV 640 MA****Product characteristics**

- Generation and monitoring of the KNX bus voltage
- With lead gel battery (ref.-no. BGA 12 AH) and cable set (ref.-no. KSB 4, KSE 2):  
buffering of the KNX bus voltage in the event of mains failure
- Up to 2 batteries can be connected
- Short-circuit proof
- Overvoltage proof
- Integrated choke
- Alarm contact for fault message

**Technical data**

## Power supply

Rated voltage:	AC 195 ... 255 V ~
Rated frequency:	45 ... 65 Hz
Power consumption:	max. 50 VA
Power loss:	max. 10 W
Ambient temperature:	-5 ... +45 °C
Storage/transport temperature:	-25 ... +70 °C (Storage above +45 °C reduces the lifetime)

## KNX

Bus output voltage:	DC 28 ... 31 V SELV
Output current:	640 mA (short-circuit proof)
Short-circuit current:	max. 1.4 A
Connection:	terminal

## Connection of fault indicator

Switching voltage AC:	AC 12 ... 230 V ~
Switching voltage DC:	DC 12 ... 24 V
Switching current AC:	max. 6 A
Switching current DC:	max. 4 A

## Battery connection

Cable length:	approx. 2 m
Fine-wire fuse:	T 6.3 A H 250 V
Rated voltage:	DC 12 V
Rated charging current:	650 mA, at battery capacity > 5 Ah 150 mA, at battery capacity < 5 Ah

Mains failure bridging time  
(battery like new)

1 battery 12 V / 12 Ah:	approx. 5.5 h
2 batteries 12 V / 12 Ah:	approx. 11 h

Mounting width: 144 mm (8 rail units)

Terminals:	screw terminals
single wire:	0.5 ... 4 mm <sup>2</sup>
stranded with ferrule:	0.2 ... 2.5 mm <sup>2</sup>



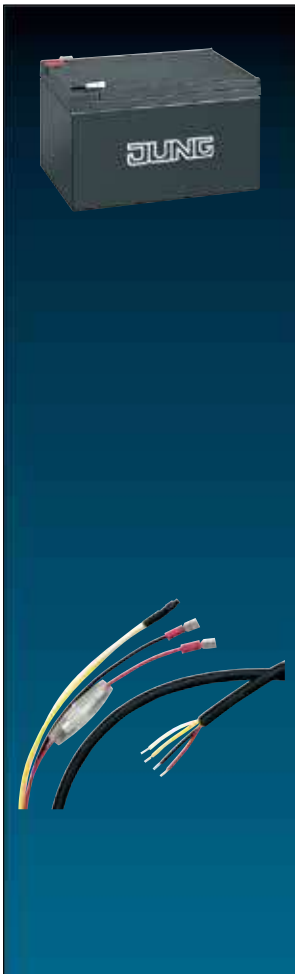

Ref.-no.

## Lead gel battery (rechargeable)

**BGA 12 AH**

12 V DC, 12 Ah

In combination with the uninterruptible KNX power supply, the lead gel battery serves for the buffering of the system voltage. Max. two lead gel batteries can be connected in parallel to the power supply.

In that case two equal lead gel batteries must be used. For the connection of a single battery the 4-wire cable set must be used, for the connection of two batteries the 4-wire cable set must be used for the first one, the second one must be connected with the 2-wire cable set.

The durability of lead gel batteries is up to 5 years.

### Technical data

Power supply

Rated voltage: 12 V DC

Battery capacity: 12 Ah

Dimensions (W x H x D): 151 x 94 x 98 mm

Weight: 4.2 kg

Ambient temperature

Operation: -20 ... +50 °C

### Cable set

Basis

**KSB 4**

Extension

**KSE 2**

For the connection of the uninterruptible KNX power supply and the lead gel battery the 4-wire cable set (for one battery) must be used. For two batteries the 4-wire and the 2-wire set must be used.

The 4-wire cable set has an integrated fuse and a temperature sensor, the 2-wire cable set has only an integrated fuse.

### Technical data KSB 4

Cable

Wires: 4-wire cable

Cross-section: 0.75 mm<sup>2</sup>

Length: 2 m

Colour battery connection: red: positive (12 V battery)  
black: negative (GND battery)

Colour temperature sensor: white: positive (12 V temp. sensor)  
yellow: negative (GND temp. sensor)

Terminals

Battery connection: for the connection to the uninterruptible power supply: ferrules  
for the connection to the battery: cable lug (6.3 x 0.8 mm)

Temperature sensor: ferrules

Fuse, model: exchangeable fuse with in-line fuse holder (screw cap)

Fuse, type: 5 x 20 mm, T6.3 H 250 V

### Technical data KSE 2

Cable

Wires: 2-wire cable

Cross-section: 0.75 mm<sup>2</sup>

Length: 2 m

Colour battery connection: red: positive (12 V battery)  
black: negative (GND battery)

Terminals

Battery connection: for the connection to the uninterruptible power supply: ferrules

for the connection to the battery: cable lug (6.3 x 0.8 mm)

Fuse, model: exchangeable fuse with in-line fuse holder (screw cap)

Fuse, type: 5 x 20 mm, T6.3 H 250 V

Ref.-no.

**USB data interface**

Rail mounting device, 2 rail units

**2130 USB REG**

The USB data interface enables the coupling of a PC for the addressing, programming and diagnoses of KNX components. The power is fully supplied by the connected PC via the USB interface.

This means that the USB data interface is no longer connected for the KNX if the USB cable is not plugged in. The device is only programmed locally with a physical address via the connected PC and therefore does not have a programming button or programming LED. The firmware of the USB data interface can be updated via a PC and is therefore safeguarded for future standards.

**Note:** The USB data interface is supported by ETS 3 software from version "a" upwards and by the PC operating systems Windows XP and Windows 7.

**Connection:** The connection to the KNX is carried out with the aid of the bus connecting terminal. The USB connection is carried out with a certified USB cable (1 x B plug required) with a max. length of 5 m.

**Technical data**

Power supply:	via USB port of the PC
Connection	
KNX:	KNX bus connection block
USB port:	USB socket, type B
Transfer rate:	9600 Baud
Transmission protocol:	compatible with USB 1.1/2.0
Length of USB cable:	max. 5 m
Ambient temperature:	-5 ... +45 °C
Storing temperature:	-25 ... +70 °C
Protection class:	II
Mounting width:	36 mm (2 rail units)

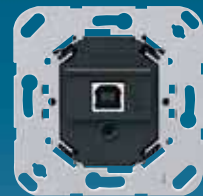
**USB data interface****2130 USB**

 Colour printing possible

 Laser labelling possible





Ref.-no.

### Centre plate



for USB data interface ref.-no.: 2130 USB

#### for AS and A ranges



##### Duroplastic (scratch-proof) glossy

ivory		A 569 PLT
white		A 569 PLT WW
black		A 569 PLT SW

##### Duroplastic lacquered

aluminium	 	A 569 PLT AL
champagne		A 569 PLT CH
mocha		A 569 PLT MO

##### Thermoplastic (breakproof) high-gloss





ivory		A 569 BFPLT
white		A 569 BFPLT WW
black		A 569 BFPLT SW

##### Thermoplastic (breakproof) lacquered

matt anthracite		A 569 BFPLT ANM
-----------------	---	-----------------



#### for CD range

##### Thermoplastic (breakproof) high-gloss

ivory		569 T
white		CD 569 T WW
grey		CD 569 T GR
light grey		CD 569 T LG
black		CD 569 T SW

#### Centre plate with inscription field 6 x 37 mm

##### Thermoplastic (breakproof) high-gloss





ivory		569 TNA
white		CD 569 TNA WW

### Centre plate

for USB data interface ref.-no.: 2130 USB

#### for LS range

##### Thermoplastic (breakproof) high-gloss

ivory		LS 969 T
white		LS 969 T WW
light grey		LS 969 T LG
black		LS 969 T SW

##### metal versions

aluminium	 	AL 2969 T
stainless steel		ES 2969 T
anthracite (aluminium lacquered)		AL 2969 T AN
dark (aluminium lacquered)		AL 2969 T D
chrome		GCR 2969 T
classic brass		ME 2969 T C
antique brass		ME 2969 T AT

Ref.-no.

**KNX RF radio USB stick****USB 2130 RF****Intended use**

- PC interface for the addressing, programming and diagnostics of KNX-RF devices
- USB stick for coupling to a PC with a Windows-based operating system

**Product characteristics**

- Commissioning, programming, visualisation and diagnostics of KNX-RF devices
- Automatic installation of PC communication via HID profile

**Technical data**

Rated voltage:	DC 5 V
USB version:	2.0
Connection USB:	type A
Ambient temperature:	-10 ... +70 °C
Relative humidity:	max. 80 % (no condensation)
Radio frequency:	868.0 ... 868.6 MHz
Transmitting power:	max. 20 mW
Transmission range in free field:	typical 100 m

**KNX RF radio converter**

Project design and commissioning with ETS5 or a more recent version.

**MK 100 RF****Intended use**

- Connection of KNX radio networks with cabled KNX lines
- Extension of the radio range in KNX radio networks (repeater operation, external power supply with 24 V AC/DC, e.g. ref.-no. NT 2415 REG VDC)
- Installation in wall box according to DIN 49073 with suitable cover



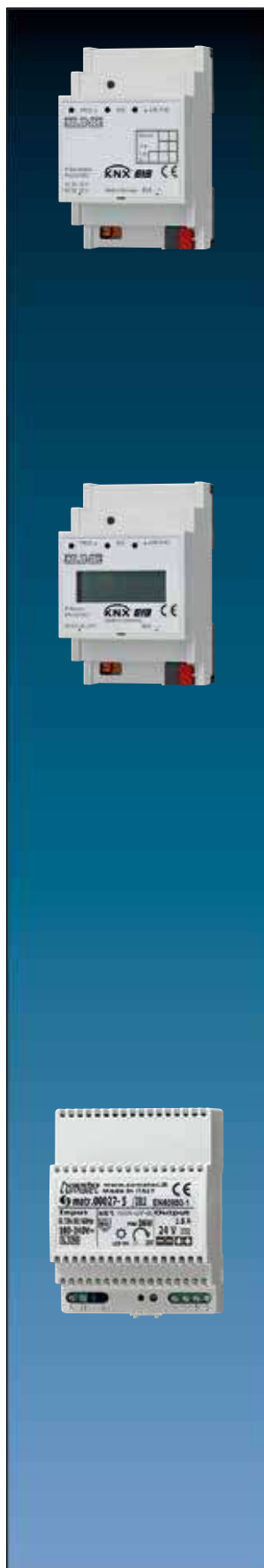

Ref.-no.

**IP interface**

Rail mounting device, 3 rail units

**IPS 200 REG****Intended use**

- Connection between KNX devices and PC or other data processing devices via IP
- Operation as data interface
- Mounting on DIN rail in distribution boxes

**Product characteristics**

- LED display for KNX communication, Ethernet communication and programming mode
- Configuration via ETS, Telnet or software tool
- Max. 5 connections to IP terminal devices, e.g. for simultaneous visualisation and configuration
- Supply from network line (Power-over-Ethernet acc. to IEEE 802.3af) through separate voltage supply ref.-no. NT 2415 REG VDC or the auxiliary voltage output of the KNX voltage supply
- Electrical isolation between KNX and IP network
- Power consumption max. 1 W

**IP router**

Rail mounting device, 3 rail units

ETS product family: System components

Product type: IP router

**IPR 200 REG****Intended use**

- Connection between KNX devices and PC or other data processing devices via IP
- Operation as line/area coupler or data interface
- Mounting on DIN rail in distribution boxes

**Product characteristics**

- KNXnet/IP routing for communication between KNX lines, areas and systems via IP network
- Telegramm forwarding and filtering according to physical address or group address
- LED display for KNX communication, Ethernet communication and programming mode
- Configuration via ETS and Telnet
- SNTP server, with battery backup
- Commissioning with display support
- Max. 5 connections to IP terminal devices, e.g. for simultaneous visualisation and configuration
- Outage message of the KNX system to the IP system
- Supply from network line (Power-over-Ethernet acc. to IEEE 802.3af) through separate voltage supply ref.-no. NT 2415 REG VDC or the auxiliary voltage output of the KNX voltage supply
- Electrical isolation between KNX and IP network
- Power consumption max. 1 W

**Power supply for rail mounting**

for Smart Control ref.-no.: SC 7 AL, SC 7 SW, SC 10, SC 15, SC 19

for IP interface ref.-no.: IPS 200 REG and IP router ref.-no.: IPR 200 REG

Rail mounting device, 4 rail units

**NT 2415 REG VDC****Technical data**

Input voltage:	AC 100 ... 240 V ~, 50/60 Hz
Input current:	730 mA
Output voltage:	24 V DC
Output current:	1.5 A
Mounting width:	72 mm (4 rail units)
Connection:	screw terminals

Ref.-no.

**Area / line coupler**

Rail mounting device, 2 rail units  
 ETS product family: System components  
 Product type: Line coupler

**2142 REG**

**Function:** The coupler connects two KNX data lines and ensures the electrical separation of these lines from one another. The definite functions of the device are defined by addressing and parameterization.

**Line coupler:** Connection of a line with a main line. Alternatively with or without filter function. The coupler belongs logically to the subordinate line (here: line).

**Area coupler:** Connection of a main line and an area line. Alternatively with or without filter function. The coupler belongs logically to the subordinate line (here: main line).

**Amplifier:** Preparation and repetition of telegrams on a line, no filter function. Division of a line into max. 4 independent line segments (max. 3 line amplifiers connected in parallel per line). Each line segment requires a separate power supply including a choke.

When using the device as an area/line coupler with the application coupler/amplifier 901011, the telegram confirmation can be parameterised additionally on "always reject" (NACK) on a line. With this parameter setting a physical access (programming/commissioning) from this line to the coupler and the other lines is no longer possible (protective function).

**Technical data**

Power supply:	21 ... 32 V DC from superordinate line
Current consumption	
superordinate line:	approx. 6 mA
subordinate line:	approx. 8 mA
Connection:	KNX bus connection block for superordinate and subordinate line
Mounting:	on DIN rail
Ambient temperature:	-5 ... +45 °C
Storing temperature:	-25 ... +70 °C
Protection class:	III acc. EN 61 140
Mounting width:	36 mm (2 rail units)

**Application unit logic**

Rail mounting device, 2 rail units  
 ETS product family: Controller  
 Product type: Controller

**ABL/S2.1****Product characteristics**

- Can be parameterised via ETS3  
 The latest .NET Framework is required.
- 50 logical functions (AND, OR, One hot)
- 50 unidirectional and bidirectional gates
- 30 timers (with ON/OFF delay, pulse duration, staircase lighting function)
- 10 comparators







**KNX DALI GATEWAY TW**  
Control Tunable White conveniently

## KNX DALI-Gateway TW

Illuminate rooms in a targeted manner and use matching colour temperatures to promote performance of people. The KNX DALI gateway TW forms the interface to the control of DALI luminaires in a KNX installation (for max. 64 DALI nodes in max. 32 groups). As well as the regular brightness control, the control of the colour temperature of white light is also performed. The lighting can thus be adjusted as required at any time.







The basic idea of Tunable White is to control the colour temperature dynamically and seamlessly from warm white (1,000 Kelvin) to cold white (10,000 Kelvin). By adapting the colour temperature to the room, the perceived quality improves. Thanks to its very good colour rendering, Tunable White stands for

a high level of lighting comfort – but also mainly for its ability to adapt artificial light dynamically to human biorhythms. This can probably improve human performance and have a positive effect on their health. The JUNG KNX DALI gateway TW is the first KNX device that offers this capability with such scope.



#### COLOUR TEMPERATURE AND BRIGHTNESS

Using the KNX DALI Gateway TW, colour temperature and brightness can be set independently of each other or combined as desired. In this way, the behaviour of an incandescent lamp can be adjusted by changing the colour temperature to the warmer range when dimming and changing to the colder range when making brighter.

Ref.-no.

## DALI gateway TW

Rail mounting device, 4 rail units  
with manual electronic operation and LED status indication  
ETS product family: Illumination  
Product type: Dimmer

2099 REGHE

### Intended use

- Controlling of luminaires and other applications with DALI operating device in KNX installations e.g. electronic ballast
- Mounting on DIN rail according to EN 60715 in distribution boxes

### Product characteristics

- Control of up to 64 DALI devices in up to 32 groups
- Setting of colour temperature for luminaires with DALI Device Type 8 for tunable white acc. to IEC 62386-209
- Suitable for operation in emergency lighting systems
- Individual, group or central addressing
- 16 light scenes
- Effect control for dynamic lighting effects or colour games
- Read out DALI device state via KNX, e.g. brightness or luminaire error
- Manual operation of the DALI groups
- Restraint function
- Feedback of switching state and brightness value in bus and manual mode
- Collective feedback
- Central switching function
- Disabling function for each DALI group
- Separate ON and OFF delay
- Staircase lighting timer with pre-warning function
- Corridor function: when combined with motion detectors, reduced continuous lighting, if no motion is detected
- Online or offline project design of the DALI devices with ETS plug-in
- Short-circuit protection
- Surge voltage protection
- Overload protection
- Operating hours counter
- Signal of the global switching status of the DALI devices, e.g. to switch off the mains voltage of the DALI devices to avoid standby losses
- An individual DALI device can be exchanged during operation without software
- Linear or logarithmic dimming characteristic can be selected

### Technical data

Rated voltage:	AC 110 ... 240 V ~, 50/60 Hz		
Rated voltage DC:	DC 110 ... 240 V		
Power loss:	max. 3 W		
Ambient temperature:	-5 ... +45 °C		
Storage/transport temperature:	-25 ... +70 °C		
Rated voltage DALI:	DC 16 V		
Number of DALI devices:	max. 64		
DALI transmission rate:	1.2 kbit/s		
DALI protocol:	EN 62386		
Cable type:	Sheathed cable 230 V, e.g. NYM		
Cable length DALI			
with 1.5 mm <sup>2</sup> :	max. 300 m	with 1.0 mm <sup>2</sup> :	max. 238 m
with 0.75 mm <sup>2</sup> :	max. 174 m	with 0.5 mm <sup>2</sup> :	max. 116 m
Mounting width:	72 mm (4 rail units)		
Connection, power supply and DALI:	screw terminals		
single wire:	0.5 ... 4 mm <sup>2</sup>		
stranded without ferrule:	0.5 ... 4 mm <sup>2</sup>		
stranded with ferrule:	0.5 ... 2.5 mm <sup>2</sup>		
KNX medium:	TP 256		
Rated voltage KNX:	DC 21 ... 32 V SELV		
Power consumption KNX:	typical 150 mW		
Connection, KNX:	terminal		





**JUNG** Schaltaktor 8fach / Jalousieaktor 4fach  
230V, 16 REG HE  
AC 230 / 240 V -  
16 A (max) 16 A (AC 230 V -  
A1-A8, 1 REG A

**JUNG** Schaltaktor 8fach / Jalousieaktor 8fach  
230 V REG HE  
AC 230 / 240 V -  
16 A (max) 16 A (AC 230 V -  
A1-A8, 1 REG A

ALL OFF  
ON / OFF

KNX

**JUNG**  
Spannungsversorgung 320 mA  
2006 REG

Netz  
Überlast  
Überstrom

DC 24V  
DC 5V  
100 mA  
100 mA

AC 230 V  
16 A (max) 16 A (AC 230 V -  
A1-A8, 1 REG A

KNX

**BVNG 650-0**  
Bus-Videon-Netzgerät  
Bus Video Power Supply  
230 V - 50/60 Hz 300 mA  
IP 30 ta 40

CE

5N40000105

**LEDLE**

Bus ON-OFF  
LEDY  
1-2-3 A  
1-2-3 A  
1-2-3 A

1-Norm-2 → Batterie

1-2-3 A  
1-2-3 A

# Actuators for rail mounting

## COMBINATION OF KNX ACTUATORS FOR RAIL MOUNTING

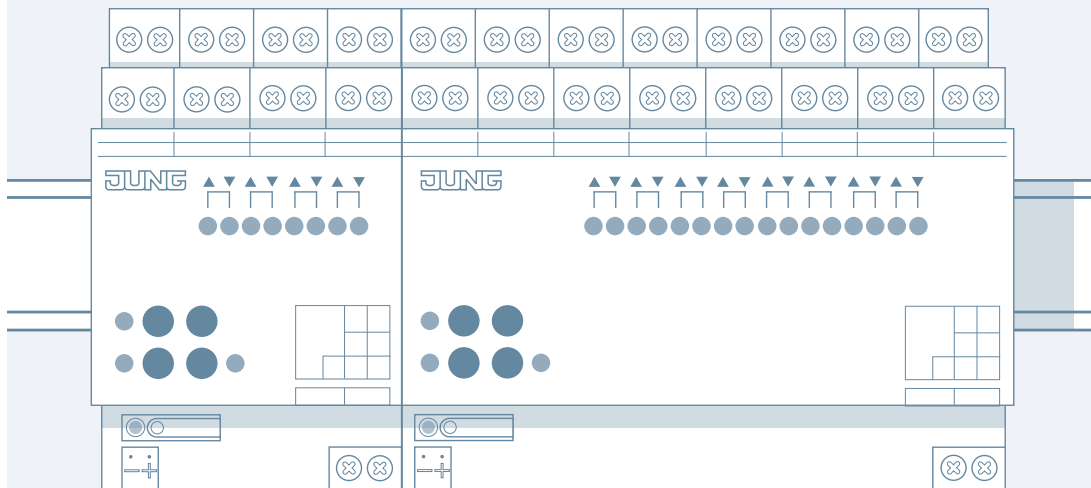

This combination of two 8-gang and 16-gang switch/blind actuators has the advantage of optimal use of space with 12 TE/24 channels and the resulting function depth.

The various KNX actuators for rail mounting are impressive due to high functionality in compact design, whereby the space in the distribution can be used optimally. Manual operability for „local operation“ and for maintenance purposes is common to all of them; also status feedbacks in manual mode. Scene operation is integrated in all switching, dimming and blind actuators.

The switching actuators are optionally available in the version with operating hours counter and current detection (measurement of the load current for each output). The JUNG KNX actuators for rail mounting also meet the applicable standards and established engineering practice of the VDE test and certification institute.



Ref.-no.

**Switch actuator, 2-gang**

Rail mounting device, 4 rail units

2 make contacts with manual mechanical operation and status indicator

ETS product family: Output

Product type: Binary output

**2302.16 REGHM****Technical data**

Rated voltage KNX:	DC 21 ... 32 V SELV
Connection, KNX:	KNX bus connection block
Power consumption KNX:	typical 150 mW
Power loss:	max. 2 W
Ambient temperature:	-5 ... +45 °C
Storage/transport temperature:	-25 ... +70 °C
Mounting width:	72 mm (4 rail units)
Connection, outputs:	screw terminals
single wire:	0.5 ... 4 mm <sup>2</sup>
stranded without ferrule:	0.5 ... 4 mm <sup>2</sup>
stranded with ferrule:	0.5 ... 2.5 mm <sup>2</sup>

**Switching outputs**

Contact type:	floating relay contacts (μ contact)
Switching voltage AC:	AC 250 / 400 V
Switching current 230 V AC1:	16 A
Switching current 230 V AC3:	10 A
Switching current 400 V AC1:	10 A
Switching current 400 V AC3:	6 A
Fluorescent lamps:	10 AX
Ohmic load:	3680 W
Capacitive load:	10 A / 140 μF
Switching voltage DC:	DC 12 ... 24 V
Switching current DC:	16 A
Min. switching current:	100 mA
Switch-on current 150 μs:	400 A
Switch-on current 600 μs:	200 A

**Lamp loads**

Incandescent lamps:	2500 W
HV halogen lamps:	2500 W
Inductive transformers	
with LV halogen lamps:	1200 VA
Electronic transformers	
with LV halogen lamps:	1500 W
Fluorescent lamps T5/T8	
non-compensated:	2500 W
parallel compensated:	1300 W / 140 μF
lead-lag circuit:	2300 W / 140 μF
Compact fluorescent lamps	
non-compensated:	2500 W
parallel compensated:	1300 W / 140 μF
Mercury vapour lamps	
non-compensated:	2000 W
parallel compensated:	2000 W / 140 μF
Approvals:	VDE



Ref.-no.

**Switch actuator, 4-gang**

Rail mounting device, 4 rail units

4 make contacts with manual mechanical operation and status indicator

ETS product family: Output

Product type: Binary output

**2304.16 REGHM****Technical data**

Rated voltage KNX:	DC 21 ... 32 V SELV
Connection, KNX:	KNX bus connection block
Power consumption KNX:	typical 150 mW
Power loss:	max. 4 W
Ambient temperature:	-5 ... +45 °C
Storage/transport temperature:	-25 ... +70 °C
Mounting width:	72 mm (4 rail units)
Connection, outputs:	screw terminals
single wire:	0.5 ... 4 mm <sup>2</sup>
stranded without ferrule:	0.5 ... 4 mm <sup>2</sup>
stranded with ferrule:	0.5 ... 2.5 mm <sup>2</sup>

**Switching outputs**

Contact type:	floating relay contacts (μ contact)
Switching voltage AC:	AC 250 / 400 V
Switching current 230 V AC1:	16 A
Switching current 230 V AC3:	10 A
Switching current 400 V AC1:	10 A
Switching current 400 V AC3:	6 A
Fluorescent lamps:	10 AX
Ohmic load:	3680 W
Capacitive load:	10 A / 140 μF
Switching voltage DC:	DC 12 ... 24 V
Switching current DC:	16 A
Min. switching current:	100 mA
Switch-on current 150 μs:	400 A
Switch-on current 600 μs:	200 A

**Lamp loads**

Incandescent lamps:	2500 W
HV halogen lamps:	2500 W
Inductive transformers	
with LV halogen lamps:	1200 VA
Electronic transformers	
with LV halogen lamps:	1500 W
Fluorescent lamps T5/T8	
non-compensated:	2500 W
parallel compensated:	1300 W / 140 μF
lead-lag circuit:	2300 W / 140 μF
Compact fluorescent lamps	
non-compensated:	2500 W
parallel compensated:	1300 W / 140 μF
Mercury vapour lamps	
non-compensated:	2000 W
parallel compensated:	2000 W / 140 μF
Approvals:	VDE





Ref.-no.

**Switch actuator, 8-gang**

Rail mounting device, 8 rail units

8 make contacts with manual mechanical operation and status indicator

Only with the ETS 3.0d version or later versions the full functionality will be available.

ETS product family: Output

Product type: Binary output

**2308.16 REGHM****Technical data**

Rated voltage KNX:	DC 21 ... 32 V SELV
Connection, KNX:	KNX bus connection block
Power consumption KNX:	typical 150 mW
Power loss:	max. 8 W
Ambient temperature:	-5 ... +45 °C
Storage/transport temperature:	-25 ... +70 °C
Mounting width:	144 mm (8 rail units)
Connection, outputs:	screw terminals
single wire:	0.5 ... 4 mm <sup>2</sup>
stranded without ferrule:	0.5 ... 4 mm <sup>2</sup>
stranded with ferrule:	0.5 ... 2.5 mm <sup>2</sup>

**Switching outputs**

Contact type:	floating relay contacts (μ contact)
Switching voltage AC:	AC 250 / 400 V
Switching current 230 V AC1:	16 A
Switching current 230 V AC3:	10 A
Switching current 400 V AC1:	10 A
Switching current 400 V AC3:	6 A
Fluorescent lamps:	10 AX
Ohmic load:	3680 W
Capacitive load:	10 A / 140 μF
Switching voltage DC:	DC 12 ... 24 V
Switching current DC:	16 A
Min. switching current:	100 mA
Switch-on current 150 μs:	400 A
Switch-on current 600 μs:	200 A

**Lamp loads**

Incandescent lamps:	2500 W
HV halogen lamps:	2500 W
Inductive transformers	
with LV halogen lamps:	1200 VA
Electronic transformers	
with LV halogen lamps:	1500 W
Fluorescent lamps T5/T8	
non-compensated:	2500 W
parallel compensated:	1300 W / 140 μF
lead-lag circuit:	2300 W / 140 μF
Compact fluorescent lamps	
non-compensated:	2500 W
parallel compensated:	1300 W / 140 μF
Mercury vapour lamps	
non-compensated:	2000 W
parallel compensated:	2000 W / 140 μF
Approvals:	VDE

Ref.-no.

**Switch actuator with C-load, 4-gang  
with current detection**

Rail mounting device, 4 rail units

4 make contacts with manual mechanical operation and status indicator

Only with the ETS 3.0d version or later versions the full functionality will be available.

ETS product family: Output

Product type: Binary output

**2304.16 REGCHM****Technical data**

Rated voltage KNX:	DC 21 ... 32 V SELV
Connection, KNX:	KNX bus connection block
Power consumption KNX:	typical 240 mW
Power loss:	max. 4 W
Ambient temperature:	-5 ... +45 °C
Storage/transport temperature:	-25 ... +70 °C
Mounting width:	72 mm (4 rail units)
Connection, outputs:	screw terminals
single wire:	0.5 ... 4 mm <sup>2</sup>
stranded without ferrule:	0.5 ... 4 mm <sup>2</sup>
stranded with ferrule:	0.5 ... 2.5 mm <sup>2</sup>

**Current detection (sine)**

Mains frequency:	50 / 60 Hz
Measuring range:	0.25 ... 16 A
Accuracy (≤ 1 A):	±100 mA
Accuracy (> 1 A):	±8 % of curr. val.

**Switching outputs**

Contact type:	floating relay contacts (μ contact)
Switching voltage AC:	AC 250 / 400 V
Switching current 230 V AC1:	16 A
Switching current 230 V AC3:	10 A
Switching current 400 V AC1:	10 A
Switching current 400 V AC3:	6 A
Fluorescent lamps:	16 AX
Ohmic load:	3680 W
Capacitive load:	16 A / 200 μF
Switching voltage DC:	DC 12 ... 24 V
Switching current DC:	16 A
Min. switching current:	100 mA
Switch-on current 150 μs:	600 A
Switch-on current 600 μs:	300 A

**Lamp loads**

Incandescent lamps:	3680 W
HV halogen lamps:	3680 W
Inductive transformers with LV halogen lamps:	2000 VA
Electronic transformers with LV halogen lamps:	2500 W
Fluorescent lamps T5/T8 non-compensated:	3680 W
parallel compensated:	2500 W / 200 μF
lead-lag circuit:	3680 W / 200 μF
Compact fluorescent lamps non-compensated:	3680 W
parallel compensated:	2500 W / 200 μF
Mercury vapour lamps non-compensated:	3680 W
parallel compensated:	3680 W / 200 μF
Approvals:	VDE





Ref.-no.

**Switch actuator with C-load, 8-gang  
with current detection**

Rail mounting device, 8 rail units

8 make contacts with manual mechanical operation and status indicator

Only with the ETS 3.0d version or later versions the full functionality will be available.

ETS product family: Output

Product type: Binary output

**2308.16 REGCHM****Technical data**

Rated voltage KNX:	DC 21 ... 32 V SELV
Connection, KNX:	KNX bus connection block
Power consumption KNX:	typical 240 mW
Power loss:	max. 8 W
Ambient temperature:	-5 ... +45 °C
Storage/transport temperature:	-25 ... +70 °C
Mounting width:	144 mm (8 rail units)
Connection, outputs:	screw terminals
single wire:	0.5 ... 4 mm <sup>2</sup>
stranded without ferrule:	0.5 ... 4 mm <sup>2</sup>
stranded with ferrule:	0.5 ... 2.5 mm <sup>2</sup>

**Current detection (sine)**

Mains frequency:	50 / 60 Hz
Measuring range:	0.25 ... 16 A
Accuracy (≤ 1 A):	±100 mA
Accuracy (> 1 A):	±8 % of curr. val.

**Switching outputs**

Contact type:	floating relay contacts (μ contact)
Switching voltage AC:	AC 250 / 400 V
Switching current 230 V AC1:	16 A
Switching current 230 V AC3:	10 A
Switching current 400 V AC1:	10 A
Switching current 400 V AC3:	6 A
Fluorescent lamps:	16 AX
Ohmic load:	3680 W
Capacitive load:	16 A / 200 μF
Switching voltage DC:	DC 12 ... 24 V
Switching current DC:	16 A
Min. switching current:	100 mA
Switch-on current 150 μs:	600 A
Switch-on current 600 μs:	300 A

**Lamp loads**

Incandescent lamps:	3680 W
HV halogen lamps:	3680 W
Inductive transformers with LV halogen lamps:	2000 VA
Electronic transformers with LV halogen lamps:	2500 W
Fluorescent lamps T5/T8 non-compensated:	3680 W
parallel compensated:	2500 W / 200 μF
lead-lag circuit:	3680 W / 200 μF
Compact fluorescent lamps non-compensated:	3680 W
parallel compensated:	2500 W / 200 μF
Mercury vapour lamps non-compensated:	3680 W
parallel compensated:	3680 W / 200 μF
Approvals:	VDE

Ref.-no.

**Switch / blinds actuator, 4/2-gang**

Rail mounting device, 4 rail units

Switch actuator: max. 4-gang

Blind actuator: max. 2-gang

Max. 2-gang switch actuator/1-gang blind actuator in combination

with manual electronic operation and LED status indication

Only with the ETS 3.0d version or later versions the full functionality will be available.

ETS product family: Output

Product type: Binary output

**2304.16 REGHE**

The total current of two adjacent outputs must not exceed 20 A.

**Technical data****Power supply**

Rated voltage: AC 110 V (-10 %) ... 240 V (+10 %)

Mains frequency: 50 / 60 Hz

Power loss: max. 2 W

Ambient temperature: -15 ... +45 °C

Storage/transport temperature: -25 ... +70 °C

**Outputs**Contact type: floating relay contacts ( $\mu$  contact)

Switch type: make contact

Switching voltage: AC 250 V ~

Switching current AC1 ( $\cos \varphi > 0.8$ ): 16 A

Fluorescent lamps: 16 AX

Current carrying capacity

Neighbouring outputs:  $\Sigma$  20 ADevice:  $\Sigma$  40 A

Loads per output

Ohmic load: 3000 W

Capacitive load: 16 A / 140  $\mu$ F

Motors: 1380 VA

Switch-on current 200  $\mu$ s: max. 800 A

Switch-on current 20 ms: max. 165 A

**Lamp loads**

Incandescent lamps: 3000 W

HV halogen lamps: 2500 W

Electronic transformers

with LV halogen lamps: 1500 W

Inductive transformers

with LV halogen lamps: 1200 VA

Fluorescent lamps T5/T8

non-compensated: 1000 W

parallel compensated: 1160 W / 140  $\mu$ Flead-lag circuit: 2300 W / 140  $\mu$ F

Compact fluorescent lamps

non-compensated: 1000 W

parallel compensated: 1160 W / 140  $\mu$ F

Mercury vapour lamps

non-compensated: 1000 W

parallel compensated: 1160 W / 140  $\mu$ F**Connection, power supply and load**

Connection mode: screw terminals

single wire: 0.5 ... 4 mm<sup>2</sup>stranded without ferrule: 0.5 ... 4 mm<sup>2</sup>stranded with ferrule: 0.5 ... 2.5 mm<sup>2</sup>**KNX**

Rated voltage KNX: DC 21 ... 32 V SELV

Power consumption KNX: typical 150 mW

Connection, KNX: terminal

Approvals: VDE

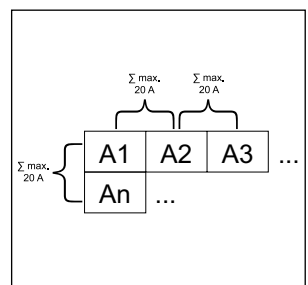



Ref.-no.

**Switch / blinds actuator, 8/4-gang**

Rail mounting device, 4 rail units  
 Switch actuator: max. 8-gang  
 Blind actuator: max. 4-gang  
 Max. 4-gang switch actuator/2-gang blind actuator in combination  
 with manual electronic operation and LED status indication  
 Only with the ETS 3.0d version or later versions the full functionality will be available.  
 ETS product family: Output  
 Product type: Binary output

**2308.16 REGHE**

The total current of two adjacent outputs must not exceed 20 A.

**Technical data**

**Power supply**

Rated voltage: AC 110 V (-10 %) ... 240 V (+10 %)  
 Mains frequency: 50 / 60 Hz  
 Power loss: max. 3 W  
 Ambient temperature: -15 ... +45 °C  
 Storage/transport temperature: -25 ... +70 °C

**Outputs**

Contact type: floating relay contacts ( $\mu$  contact)  
 Switch type: make contact  
 Switching voltage: AC 250 V ~  
 Switching current AC1 ( $\cos \varphi > 0.8$ ): 16 A  
 Fluorescent lamps: 16 AX  
 Current carrying capacity  
 Neighbouring outputs:  $\Sigma$  20 A  
 Device:  $\Sigma$  80 A  
 Loads per output  
 Ohmic load: 3000 W  
 Capacitive load: 16 A / 140  $\mu$ F  
 Motors: 1380 VA  
 Switch-on current 200  $\mu$ s: max. 800 A  
 Switch-on current 20 ms: max. 165 A

**Lamp loads**

Incandescent lamps: 3000 W  
 HV halogen lamps: 2500 W  
 Electronic transformers  
 with LV halogen lamps: 1500 W  
 Inductive transformers  
 with LV halogen lamps: 1200 VA  
 Fluorescent lamps T5/T8  
 non-compensated: 1000 W  
 parallel compensated: 1160 W / 140  $\mu$ F  
 lead-lag circuit: 2300 W / 140  $\mu$ F  
 Compact fluorescent lamps  
 non-compensated: 1000 W  
 parallel compensated: 1160 W / 140  $\mu$ F  
 Mercury vapour lamps  
 non-compensated: 1000 W  
 parallel compensated: 1160 W / 140  $\mu$ F

**Connection, power supply and load**

Connection mode: screw terminals  
 single wire: 0.5 ... 4 mm<sup>2</sup>  
 stranded without ferrule: 0.5 ... 4 mm<sup>2</sup>  
 stranded with ferrule: 0.5 ... 2.5 mm<sup>2</sup>

**KNX**

Rated voltage KNX: DC 21 ... 32 V SELV  
 Power consumption KNX: typical 150 mW  
 Connection, KNX: terminal  
 Approvals: VDE

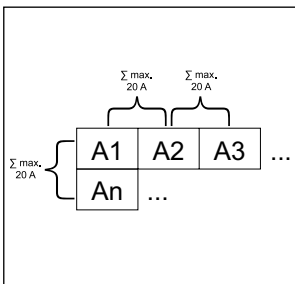



Ref.-no.

**Switch / blinds actuator, 16/8-gang**

Rail mounting device, 8 rail units

Switch actuator: max. 16-gang

Blind actuator: max. 8-gang

Max. 6-gang switch actuator/5-gang blind actuator in combination  
with manual electronic operation and LED status indication

Only with the ETS 3.0d version or later versions the full functionality will be available.

ETS product family: Output

Product type: Binary output

**2316.16 REGHE**

The total current of two adjacent outputs must not exceed 20 A.

**Technical data****Power supply**

Rated voltage: AC 110 V (-10 %) ... 240 V (+10 %)

Mains frequency: 50 / 60 Hz

Power loss: max. 4.5 W

Ambient temperature: -15 ... +45 °C

Storage/transport temperature: -25 ... +70 °C

**Outputs**Contact type: floating relay contacts ( $\mu$  contact)

Switch type: make contact

Switching voltage: AC 250 V ~

Switching current AC1 ( $\cos \varphi > 0.8$ ): 16 A

Fluorescent lamps: 16 AX

Current carrying capacity

Neighbouring outputs:  $\Sigma$  20 ADevice:  $\Sigma$  160 A

Loads per output

Ohmic load: 3000 W

Capacitive load: 16 A / 140  $\mu$ F

Motors: 1380 VA

Switch-on current 200  $\mu$ s: max. 800 A

Switch-on current 20 ms: max. 165 A

**Lamp loads**

Incandescent lamps: 3000 W

HV halogen lamps: 2500 W

Electronic transformers

with LV halogen lamps: 1500 W

Inductive transformers

with LV halogen lamps: 1200 VA

Fluorescent lamps T5/T8

non-compensated: 1000 W

parallel compensated: 1160 W / 140  $\mu$ Flead-lag circuit: 2300 W / 140  $\mu$ F

Compact fluorescent lamps

non-compensated: 1000 W

parallel compensated: 1160 W / 140  $\mu$ F

Mercury vapour lamps

non-compensated: 1000 W

parallel compensated: 1160 W / 140  $\mu$ F**Connection, power supply and load**

Connection mode: screw terminals

single wire: 0.5 ... 4 mm<sup>2</sup>stranded without ferrule: 0.5 ... 4 mm<sup>2</sup>stranded with ferrule: 0.5 ... 2.5 mm<sup>2</sup>**KNX**

Rated voltage KNX: DC 21 ... 32 V SELV

Power consumption KNX: typical 150 mW

Connection, KNX: terminal

Approvals: VDE

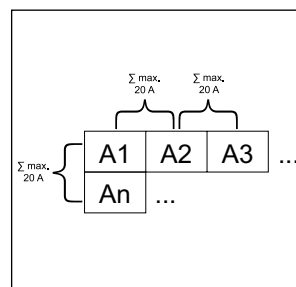



Ref.-no.

**Blinds actuator, 4-gang DC 12 – 48 V**

Rail mounting device, 4 rail units  
 with manual electronic operation and LED status indication  
 Only with the ETS 3.0d version or later versions the full functionality will be available.  
 ETS product family: Shutter  
 Product type: Shutter

**2424 REGHE****Technical data**

Outputs:	4 independent channels for one blind/shutter motor each
Contact type:	floating make contact
Switching voltage DC:	DC 12 ... 48 V
Breaking capacity DC 12 V:	6 A
Breaking capacity DC 24 V:	6 A
Breaking capacity DC 48 V:	3 A
Min. switching current DC:	100 mA
Connection:	screw terminals
single wire:	0.5 ... 4 mm <sup>2</sup>
stranded without ferrule:	0.5 ... 4 mm <sup>2</sup>
stranded with ferrule:	0.5 ... 2.5 mm <sup>2</sup>

**Blinds actuator, 2-gang AC 110 – 230 V, 1-gang DC 12 – 48 V**

Rail mounting device, 4 rail units  
 with manual electronic operation and LED status indication  
 Only with the ETS 3.0d version or later versions the full functionality will be available.  
 ETS product family: Shutter  
 Product type: Shutter

**2502 REGHE****Technical data**

Outputs:	2 channels AC 110 ... 230 V, 1 channel DC 12 ... 48 V
Power supply mains:	AC 110 V (–10 %) ... 240 V (+10 %)
Mains frequency:	50 / 60 Hz
Connection:	screw terminals
single wire:	0.5 ... 4 mm <sup>2</sup>
stranded without ferrule:	0.5 ... 4 mm <sup>2</sup>
stranded with ferrule:	0.5 ... 2.5 mm <sup>2</sup>
Breaking capacity AC1:	6 A (230 V)
Switching current DC 12/24 V:	6 A
Switching current DC 48 V:	3 A
Max. blind/shutter running time:	20 min
Power loss:	max. 4.5 W
Ambient temperature:	–5 ... +45 °C
Storing temperature:	–25 ... +70 °C
Approvals:	VDE

Ref.-no.

**Blinds actuator, 4-gang AC 110 – 230 V, 2-gang DC 12 – 48 V**

Rail mounting device, 4 rail units  
 with manual electronic operation and LED status indication  
 Only with the ETS 3.0d version or later versions the full functionality will be available.  
 ETS product family: Shutter  
 Product type: Shutter

**2504 REGHE****Technical data**

Outputs:	4 channels AC 110 ... 230 V, 2 channels DC 12 ... 48 V
Power supply mains:	AC 110 V (-10 %) ... 240 V (+10 %)
Mains frequency:	50 / 60 Hz
Connection:	screw terminals
single wire:	0.5 ... 4 mm <sup>2</sup>
stranded without ferrule:	0.5 ... 4 mm <sup>2</sup>
stranded with ferrule:	0.5 ... 2.5 mm <sup>2</sup>
Breaking capacity AC1:	6 A (230 V)
Switching current DC 12/24 V:	6 A
Switching current DC 48 V:	3 A
Max. blind/shutter running time:	20 min
Power loss:	max. 4.5 W
Ambient temperature:	-5 ... +45 °C
Storing temperature:	-25 ... +70 °C
Approvals:	VDE

**Blinds actuator, 4-gang AC 110 – 230 V, 2-gang DC 12 – 48 V**

Rail mounting device, 4 rail units  
 with manual electronic operation and LED status indication  
 Blind/shutter correction for lower end position (e.g. for ventilation position for roller blinds)  
 Only with the ETS 3.0d version or later versions the full functionality will be available.  
 ETS product family: Shutter  
 Product type: Shutter

**2514 REGHE****Technical data**

Outputs:	4 channels AC 110 ... 230 V, 2 channels DC 12 ... 48 V
Power supply mains:	AC 110 V (-10 %) ... 240 V (+10 %)
Mains frequency:	50 / 60 Hz
Connection:	screw terminals
single wire:	0.5 ... 4 mm <sup>2</sup>
stranded without ferrule:	0.5 ... 4 mm <sup>2</sup>
stranded with ferrule:	0.5 ... 2.5 mm <sup>2</sup>
Breaking capacity AC1:	6 A (230 V)
Switching current DC 12/24 V:	6 A
Switching current DC 48 V:	3 A
Max. blind/shutter running time:	20 min
Power loss:	max. 4.5 W
Ambient temperature:	-5 ... +45 °C
Storing temperature:	-25 ... +70 °C
Approvals:	VDE





Ref.-no.

**Blinds actuator, 8-gang AC 110 – 230 V, 4-gang DC 12 – 48 V**

Rail mounting device, 8 rail units

with manual electronic operation and LED status indication

Only with the ETS 3.0d version or later versions the full functionality will be available.

ETS product family: Shutter

Product type: Shutter

**2508 REGHE****Technical data**

Outputs:	8 channels AC 110 ... 230 V, 4 channels DC 12 ... 48 V
Power supply mains:	AC 110 V (-10 %) ... 240 V (+10 %)
Mains frequency:	50 / 60 Hz
Connection:	screw terminals
single wire:	0.5 ... 4 mm <sup>2</sup>
stranded without ferrule:	0.5 ... 4 mm <sup>2</sup>
stranded with ferrule:	0.5 ... 2.5 mm <sup>2</sup>
Breaking capacity AC1:	6 A (230 V)
Switching current DC 12/24 V:	6 A
Switching current DC 48 V:	3 A
Max. blind/shutter running time:	20 min
Power loss:	max. 6 W
Ambient temperature:	-5 ... +45 °C
Storing temperature:	-25 ... +70 °C
Approvals:	VDE

Ref.-no.

**Shutter actuator 4-gang AC 110 – 230 V**

Rail mounting device, 4 rail units  
with manual electronic operation and LED status indication  
ETS product family: Shutter  
Product type: Shutter

**2504 REGHER****Product characteristics**

- Outputs can be operated manually, construction site mode
  - Blind/shutter position directly controllable
  - Acknowledgement of the blind/shutter position in bus and manual mode
  - Safety functions: 3 independent wind alarms, rain alarm, frost alarm
  - Integration into the temperature management of the building
  - Disabling of individual outputs manually or via bus
- 
- No central function
  - No end position detection
  - No feedback for drive movement
  - No sun protection
  - No scene function
  - No forced position
  - No fabric-stretching

**Technical data**

Rated voltage:	AC 110 V (–10 %) ... 240 V (+10 %)
Mains frequency:	50 / 60 Hz
Switching voltage:	AC 250 V ~
Switching current AC 250 V:	6 A
Switching current DC 12/24 V:	6 A
Switching current DC 48 V:	3 A
Connection, power supply and load:	screw terminals
single wire:	0.5 ... 4 mm <sup>2</sup>
stranded without ferrule:	0.5 ... 4 mm <sup>2</sup>
stranded with ferrule:	0.5 ... 2.5 mm <sup>2</sup>
Max. blind/shutter running time:	20 min
Mounting width:	72 mm (4 rail units)
Ambient temperature:	–5 ... +45 °C
Storage/transport temperature:	–25 ... +70 °C
Power loss:	max. 4.5 W
Rated voltage KNX:	DC 21 ... 32 V SELV
Power consumption KNX:	typical 150 mW
Connection, KNX:	terminal
Approvals:	VDE





Ref.-no.

**LED universal dimming actuator / speed regulator, 1-gang**

1 x 500 W, HV LED lamps typ. 3 ... 100 W

Rail mounting device, 4 rail units • ETS product family: Illumination • Product type: Dimmer

**3901 REGHE****Intended use**

• Switching and dimming of incandescent lamps, HV halogen lamps, dimmable HV-LED lamps, dimmable compact fluorescent lamps, dimmable inductive transformers with LV halogen or LV LED lamps, dimmable electronic transformers with LV halogen or LV LED lamps • Mounting on DIN rail according to EN 60715 in distribution boxes • Speed controller for regulating the speed of single-phase motors e.g. induction motors, shaded pole motors or universal motors

**Product characteristics**

• Automatic or manual selection of the dimming principle suitable for the load • Protected against no-load, short-circuit and overheating • Signal in the event of a short-circuit • Outputs can be operated manually • Feedback of the switching position and the dimming value • Parameterisable switch-on and dimming behaviour • Time functions: switch-on delay, switch-off delay, staircase lighting timer with run-on time • Light scene operation • Disabling of individual outputs manually or by bus • Status indicator of the outputs via LED • Operating hours counter • Mains failure longer than approx. 5 seconds leads to switch-off of the dimmer actuator. Depending on the parameter setting, the connected load is calibrated after resumption of power supply.

**Technical data**

Rated voltage:	AC 110 ... 230 V ~, 50/60 Hz
Power loss:	max. 4 W
Stand-by power:	max. 0.5 W
Ambient temperature:	-5 ... +45 °C
Storage/transport temperature:	-25 ... +70 °C
Contact type:	ε, MOSFET

**Motor loads**

Motor switching current:	2.3 A
--------------------------	-------

**Lamp loads**

Connected load, 230 V per output

Incandescent lamps:	20 ... 500 W
HV halogen lamps:	20 ... 500 W
Inductive transformers:	20 ... 500 VA
Inductive transformers with LV-LED:	20 ... 100 VA
Electronic transformers:	20 ... 500 W
Electronic transformers with LV-LED:	20 ... 100 W
Dimmable HV LED lamps:	typical 3 ... 100 W
Dimmable compact fluorescent lamps:	typical 3 ... 100 W
Ohmic-inductive:	20 ... 500 VA
Ohmic-capacitive:	20 ... 500 W
Capacitive-inductive:	not permitted

Connected load, 110 V per output

Incandescent lamps:	20 ... 250 W
HV halogen lamps:	20 ... 250 W
Inductive transformers:	20 ... 250 VA
Inductive transformers with LV-LED:	20 ... 50 VA
Electronic transformers:	20 ... 250 W
Electronic transformers with LV-LED:	20 ... 50 W
Dimmable HV LED lamps:	typical 3 ... 50 W
Dimmable compact fluorescent lamps:	typical 3 ... 50 W
Ohmic-inductive:	20 ... 250 VA
Ohmic-capacitive:	20 ... 250 W
Capacitive-inductive:	not permitted

Connection:

single wire:	0.5 ... 4 mm <sup>2</sup>
stranded without ferrule:	0.5 ... 4 mm <sup>2</sup>
stranded with ferrule:	0.5 ... 2.5 mm <sup>2</sup>

Mounting width:

72 mm (4 rail units)

Approvals:

VDE



Ref.-no.

**LED universal dimming actuator, 2-gang**

2 x 300 W, HV LED lamps typ. 2 x 3 ... 60 W

Rail mounting device, 4 rail units

ETS product family: Illumination • Product type: Dimmer

**3902 REGHE****Intended use**

• Switching and dimming of incandescent lamps, HV halogen lamps, dimmable HV-LED lamps, dimmable compact fluorescent lamps, dimmable inductive transformers with LV halogen or LV LED lamps, dimmable electronic transformers with LV halogen or LV LED lamps • Mounting on DIN rail according to EN 60715 in distribution boxes

**Product characteristics**

• Automatic or manual selection of the dimming principle suitable for the load • Protected against no-load, short-circuit and overheating • Signal in the event of a short-circuit • Outputs can be operated manually • Feedback of the switching position and the dimming value • Parameterisable switch-on and dimming behaviour • Time functions: switch-on delay, switch-off delay, staircase lighting timer with run-on time • Light scene operation • Disabling of individual outputs manually or by bus • Status indicator of the outputs via LED • Operating hours counter • Mains failure longer than approx. 5 seconds leads to switch-off of the dimmer actuator. • Depending on the parameter setting, the connected load is calibrated after resumption of power supply.

**Technical data**

Rated voltage:	AC 110 ... 230 V ~, 50/60 Hz
Power loss:	max. 4 W
Stand-by power:	max. 0.8 W
Ambient temperature:	-5 ... +45 °C
Storage/transport temperature:	-25 ... +70 °C
Contact type:	ε, MOSFET

**Lamp loads**

Connected load, 230 V per output

Incandescent lamps:	20 ... 300 W
HV halogen lamps:	20 ... 300 W
Inductive transformers:	20 ... 300 VA
Inductive transformers with LV-LED:	20 ... 100 VA
Electronic transformers:	20 ... 300 W
Electronic transformers with LV-LED:	20 ... 100 W
Dimmable HV LED lamps:	typical 3 ... 60 W
Dimmable compact fluorescent lamps:	typical 3 ... 60 W
Ohmic-inductive:	20 ... 300 VA
Ohmic-capacitive:	20 ... 300 W
Capacitive-inductive:	not permitted

Connected load, 110 V per output

Incandescent lamps:	20 ... 150 W
HV halogen lamps:	20 ... 150 W
Inductive transformers:	20 ... 150 VA
Inductive transformers with LV-LED:	20 ... 50 VA
Electronic transformers:	20 ... 150 W
Electronic transformers with LV-LED:	20 ... 50 W
Dimmable HV LED lamps:	typical 3 ... 30 W
Dimmable compact fluorescent lamps:	typical 3 ... 30 W
Ohmic-inductive:	20 ... 150 VA
Ohmic-capacitive:	20 ... 150 W
Capacitive-inductive:	not permitted

Connection:

single wire:	0.5 ... 4 mm <sup>2</sup>
stranded without ferrule:	0.5 ... 4 mm <sup>2</sup>
stranded with ferrule:	0.5 ... 2.5 mm <sup>2</sup>

Mounting width:

72 mm (4 rail units)

Approvals:

VDE







Ref.-no.

**LED universal dimming actuator, 4-gang**

4 x 250 W, HV LED lamps typ. 4 x 3 ... 50 W

1 x 950 W

Rail mounting device, 8 rail units

ETS product family: Illumination • Product type: Dimmer

**3904 REGHE****Intended use**

• Switching and dimming of incandescent lamps, HV halogen lamps, dimmable HV-LED lamps, dimmable compact fluorescent lamps, dimmable inductive transformers with LV halogen or LV LED lamps, dimmable electronic transformers with LV halogen or LV LED lamps • Mounting on DIN rail according to EN 60715 in distribution boxes

**Product characteristics**

• Automatic or manual selection of the dimming principle suitable for the load • Protected against no-load, short-circuit and overheating • Signal in the event of a short-circuit • Outputs can be operated manually • Feedback of the switching position and the dimming value • Parameterisable switch-on and dimming behaviour • Time functions: switch-on delay, switch-off delay, staircase lighting timer with run-on time • Light scene operation • Disabling of individual outputs manually or by bus • Status indicator of the outputs via LED • Operating hours counter • Mains failure longer than approx. 5 seconds leads to switch-off of the dimmer actuator. • Depending on the parameter setting, the connected load is calibrated after resumption of power supply. • Increase in output power possible through parallel switching of multiple outputs (max. 950 W)

**Technical data**

Rated voltage:	AC 110 ... 230 V ~, 50/60 Hz
Power loss:	max. 8 W
Stand-by power:	max. 1.4 W
Ambient temperature:	-5 ... +45 °C
Storage/transport temperature:	-25 ... +70 °C
Contact type:	ε, MOSFET

**Lamp loads**

Connected load, 230 V per output

Incandescent lamps:	20 ... 250 W
HV halogen lamps:	20 ... 250 W
Inductive transformers:	20 ... 250 VA
Inductive transformers with LV-LED:	20 ... 100 VA
Electronic transformers:	20 ... 250 W
Electronic transformers with LV-LED:	20 ... 100 W
Dimmable HV LED lamps:	typical 3 ... 50 W
Dimmable compact fluorescent lamps:	typical 3 ... 50 W
Ohmic-inductive:	20 ... 250 VA
Ohmic-capacitive:	20 ... 250 W
Capacitive-inductive:	not permitted

Connected load, 110 V per output

Incandescent lamps:	20 ... 120 W
HV halogen lamps:	20 ... 120 W
Inductive transformers:	20 ... 120 VA
Inductive transformers with LV-LED:	20 ... 50 VA
Electronic transformers:	20 ... 120 W
Electronic transformers with LV-LED:	20 ... 50 W
Dimmable HV LED lamps:	typical 3 ... 24 W
Dimmable compact fluorescent lamps:	typical 3 ... 24 W
Ohmic-inductive:	20 ... 120 VA
Ohmic-capacitive:	20 ... 120 W
Capacitive-inductive:	not permitted

Connection:

single wire:	0.5 ... 4 mm <sup>2</sup>
stranded without ferrule:	0.5 ... 4 mm <sup>2</sup>
stranded with ferrule:	0.5 ... 2.5 mm <sup>2</sup>

Mounting width:

144 mm (8 rail units)

Approvals:

VDE



Ref.-no.

**LED dimming actuator 4-gang**

Rail mounting device, 4 rail units

**3904 REG LED****Intended use**

- LED dimmer for controlling LEDs and LED modules 12 – 24 V (pulse width-modulated PWM)
- Mounting on DIN rail according to EN 60715 in distribution boxes

**Product characteristics**

- 4 individually configurable LED dimming channels
- Maximum output current of 5 A per channel
- At 24 V DC up to 480 W LED output
- Possible channel combinations:
  - 4 x independent channels
  - 2 x Tunable White channels
  - 2 x independent channels, 1 x Tunable White channel
  - 1 x RGB channel, 1 x independent channel
  - 1 x RGBW channel
- Activation of the colour channels via "HSV" or "RGB"
- Integrated 230 V C-load relay to switch the LED power supply
- Integrated protection with on-site display against:
  - Overcurrent
  - Overvoltage
  - Overtemperature
  - Reverse polarity

**Technical data**

Rated voltage:	AC 230 V ~
Mains frequency:	50 Hz
Rated current:	16 A (C load)
Power loss:	max. 6 W
Connection:	screw terminals
single wire:	2.5 ... 4 mm <sup>2</sup>
stranded without ferrule:	4 mm <sup>2</sup>
stranded with ferrule:	2.5 mm <sup>2</sup>
Rated voltage KNX:	DC 21 ... 32 V SELV
Current consumption KNX:	max. 18.9 mA
Connection, KNX:	terminal
LED	
Connection:	DC 12 ... 24 V SELV < 20 A from device acc. to EN 61347-2-13 for LED modules with constant output voltage
Current consumption:	20 mA
Outputs	
Number:	4
Max. current per output:	5 A
For LED modules with constant input voltage to EN 62031.	
LED modules with shared anode.	
PWM frequency:	488 / 600 Hz
Cable length:	depending on the cable resistance (voltage drop)
Connection:	screw terminals
single wire:	4 mm <sup>2</sup>
stranded without ferrule:	4 mm <sup>2</sup>
Mounting width:	72 mm (4 rail units)
Ambient temperature:	-5 ... +45 °C
Storage/transport temperature:	-25 ... +70 °C





Ref.-no.

**LED dimming actuator 4-gang****3904 EB LED****Intended use**

- LED dimmer for controlling LEDs and LED modules 12 – 24 V (pulse width-modulated PWM)
- Mounting in false ceilings, surface mounting or in/ under furniture

**Product characteristics**

- 4 individually configurable LED dimming channels
- Maximum output current of 5 A per channel
- At 24 V DC up to 480 W LED output
- Possible channel combinations:
  - 4 x independent channels
  - 2 x Tunable White channels
  - 2 x independent channels, 1 x Tunable White channel
  - 1 x RGB channel, 1 x independent channel
  - 1 x RGBW channel
- Activation of the colour channels via "HSV" or "RGB"
- Integrated 230 V C-load relay to switch the LED power supply
- Integrated protection with on-site display against:
  - Overcurrent
  - Overvoltage
  - Overtemperature
  - Reverse polarity

**Technical data**

Rated voltage:	AC 230 V ~
Mains frequency:	50 Hz
Rated current:	16 A (C load)
Power loss:	max. 6 W
Connection:	screw terminals
single wire:	2.5 ... 4 mm <sup>2</sup>
stranded without ferrule:	4 mm <sup>2</sup>
stranded with ferrule:	2.5 mm <sup>2</sup>
Rated voltage KNX:	DC 21 ... 32 V SELV
Current consumption KNX:	max. 18.9 mA
Connection, KNX:	terminal
LED	
Connection:	DC 12 ... 24 V SELV < 20 A from device acc. to EN 61347-2-13 for LED modules with constant output voltage
Current consumption:	20 mA
Outputs	
Number:	4
Max. current per output:	5 A
For LED modules with constant input voltage to EN 62031.	
LED modules with shared anode.	
PWM frequency:	488 / 600 Hz
Cable length:	depending on the cable resistance (voltage drop)
Connection:	screw terminals
single wire:	4 mm <sup>2</sup>
stranded without ferrule:	4 mm <sup>2</sup>
Dimensions (L x W x H):	196 x 40 x 32 mm
Protection level:	IP 20
Protection class:	II
Ambient temperature:	-5 ... +45 °C
Storage/transport temperature:	-25 ... +70 °C



Ref.-no.

**Control unit 1 – 10 V, 4-gang**

Rail mounting device, 4 rail units  
 ETS product family: Illumination  
 Product type: Dimmer

**2194 REGHM****Intended use**

• Switching and brightness setting for lamps with operating devices with 1 – 10 V interface • Switching of electrical loads • Mounting on DIN rail according to EN 60715 in distribution boxes

**Product characteristics**

• Manual switching of the relays is independent of the bus • Switching of capacitive loads and the resulting high switch-on currents • Flexible assignment of control inputs to switching outputs, e.g. to control RGBW lamps  
 • Operation of the switching outputs as a switching actuator • Connection of different phase conductors possible • No additional power supply necessary • Feedback of switching state and brightness value • Switch position display • Burn-in function for fluorescent lamps • Switch-on and dimming behaviour can be set • Time functions: switch-on delay, switch-off delay, staircase lighting timer with pre-warning function • Integration into light scenes • Operating hours counter

**Technical data**

Rated voltage KNX: DC 21 ... 32 V SELV  
 Current consumption KNX: max. 6 mA  
 Power loss: max. 4 W  
 Ambient temperature: –5 ... +45 °C  
 Storage/transport temperature: –25 ... +70 °C

**Control outputs**

Control voltage: 1 ... 10 V  
 Control current per output: max. 100 mA  
 Cable length: max. 500 m (0.5 mm<sup>2</sup>)

**Switching outputs**

Contact type: floating relay contacts (μ contact)  
 Switching voltage AC: AC 250 / 400 V  
 Switching current 230 V AC1: 16 A  
 Switching current 230 V AC3: 10 A  
 Switching current 400 V AC1: 10 A  
 Switching current 400 V AC3: 6 A  
 Fluorescent lamps: 16 AX  
 Switching voltage DC: DC 12 ... 24 V  
 Switching current DC: 16 A  
 Min. switching current: 100 mA  
 Switch-on current 150 μs: 600 A  
 Switch-on current 600 μs: 300 A  
 Ohmic load: 3680 W  
 Capacitive load: 16 A / 200 μF

**Lamp loads**

Incandescent lamps:	3680 W	Compact fluorescent lamps	
HV halogen lamps:	3680 W	non-compensated:	3680 W
Inductive transformers		parallel compensated:	2500 W / 200 μF
with LV halogen lamps:	2000 VA	Mercury vapour lamps	
Electronic transformers		non-compensated:	3680 W
with LV halogen lamps:	2500 W	parallel compensated:	3680 W / 200 μF
Fluorescent lamps T5/T8			
non-compensated:	3680 W		
parallel compensated:	2500 W / 200 μF		
lead-lag circuit:	3680 W / 200 μF		
Connection, outputs:	screw terminals		
single wire:	0.5 ... 4 mm <sup>2</sup>		
stranded without ferrule:	0.34 ... 4 mm <sup>2</sup>		
stranded with ferrule:	0.14 ... 2.5 mm <sup>2</sup>		
Mounting width:	72 mm (4 rail units)		



Ref.-no.

**Fan coil actuator 2-gang**

Rail mounting device, 4 rail units

with manual electronic operation and LED status indication

Only with the ETS 3.0d version or later versions the full functionality will be available.

ETS product family: Heating, A/C, Ventilation

Product type: Fan-coil

**FCA 2 REGHE****Product characteristics**

- Connection of a fan coil unit with up to 6 fan stages or connection of fan coil units with up to 3 fan stages respectively
- Manual output control, provisional operation
- Control options for heating, cooling or combined heating/cooling operation
- 2-pipe or 4-pipe operation
- Individual or hierarchical switching of fan stages
- Feedback
- Output state indication
- Disabling function for each channel

**Modes of operation**

- Bus operation: operation via touch sensors or room controller
- Temporary manual control: manual operation locally with keypad, automatic return to bus operation
- Permanent manual control mode: only manual operation locally on device

**Technical data**

KNX supply:	DC 21 ... 32 V SELV
Power consumption KNX:	typical 150 mW
Rated voltage:	AC 230/240 V ~, 50/60 Hz
Power loss:	max. 3 W
Ambient temperature:	-5 ... +45 °C
Storing temperature:	-25 ... +70 °C
Connection, KNX:	bus connection block
Connection, mains and outputs:	screw terminals
single wire:	0.5 ... 4 mm <sup>2</sup>
stranded without ferrule:	0.5 ... 4 mm <sup>2</sup>
stranded with ferrule:	0.5 ... 2.5 mm <sup>2</sup>
Switch type:	make contact
Contact type:	floating relay contacts (μ contact)
Switching voltage:	AC 230/240 V ~
Breaking capacity AC1:	10 A
Breaking capacity AC3:	10 A

**Switching capacities per output**

Ohmic load:	2300 W
Capacitive load:	10 A / max. 140 μF
Motors:	1380 VA
Lamp loads:	
Incandescent lamps:	2300 W
HV halogen lamps:	2300 W
Inductive transformers	
with LV halogen lamps:	1200 VA
Electronic transformers	
with LV halogen lamps:	1500 W
Fluorescent lamps:	
- non-compensated:	1000 W
- parallel compensated:	1160 W / 140 μF
- lead-lag circuit:	2300 W / 140 μF
Approvals:	VDE

Ref.-no.

**Room actuator 110 – 230 V**

Rail mounting device, 4 rail units  
with manual electronic operation and LED status indication  
Only with the ETS 3.0d version or later versions the full functionality will be available.  
ETS product family: Output  
Product type: Binary output

RA 23024 REGHE

**Intended use**

- Switching of electrical consumers AC 110 – 230 V with floating contacts
- Switching of electrically operated blinds, shutters, awnings and similar curtains
- Heating outputs: electronic outputs for switching electro-thermal valve drives

**Product characteristics**

- Manual output control, provisional operation
- Feedback in manual control mode and in bus operation
- Scene function
- Disabling of individual outputs by hand or via the bus

**Switching function**

- Make-contact and break-contact operation
- Logic operation and forcing function
- Feedback function
- Central switching function with group feedback
- Time functions: ON-delay, OFF-delay, staircase lighting timer with early-warning function

**Technical data**

KNX supply:	DC 21 ... 32 V SELV
Power consumption KNX:	max. 150 mW
Power supply mains:	AC 110 ... 230 V ~, 50/60 Hz
Power loss:	max. 6 W
Ambient temperature:	-5 ... +45 °C
Storing temperature:	-25 ... +70 °C
Mounting width:	72 mm (4 rail units)
Connection, KNX:	bus connection block
Connection, mains and outputs:	screw terminals
single wire:	0.5 ... 4 mm <sup>2</sup>
stranded without ferrule:	0.5 ... 4 mm <sup>2</sup>
stranded with ferrule:	0.5 ... 2.5 mm <sup>2</sup>

**Heating outputs**

Number:	2
Contact type:	semiconductor, $\epsilon$
Switching voltage:	AC 230/240 V ~
Switching current:	5 ... 50 mA
Switch-on current:	max. 1.5 A (2 s)
Number of drives per output:	max. 4
Approvals:	VDE

**Blind/shutter function**

- Suitable for AC motors 110 – 230 V
- Direct control of blind/shutter position
- Direct control of slat position
- Checkback of running state, blind/shutter position and slat position
- Forced-control position from primary control
- Safety function: 3 independent wind alarms, rain alarm, frost alarm
- Sun protection function

**Control of valve drives 230 V**

- Switching or PWM operation
- Control of valve drives with working characteristics "normally open" or "normally closed"
- Overload and short-circuit protection
- Emergency operation in the event of bus failure for summer and winter
- Protection against jamming valves
- Forced-control position

**Relay outputs**

Number:	4 (2 channels for operating blinds)
Contact type:	floating make contact ( $\mu$ contact)
Switching voltage:	AC 230/240 V ~
Breaking capacity AC1:	16 A
Breaking capacity AC3:	6 A
Breaking capacity fluorescent lamps:	16 AX
<b>Switching capacities per output</b>	
Ohmic load:	3000 W
Capacitive load:	16 A / max. 140 $\mu$ F
Motors:	1380 VA
Lamp loads:	
Incandescent lamps:	3000 W
HV halogen lamps:	2500 W
Electronic transformers with LV halogen lamps:	1500 W
Inductive transformers with LV halogen lamps:	1200 VA
Fluorescent lamps:	
– non-compensated:	1000 W
– parallel compensated:	1160 W / max. 140 $\mu$ F
– lead-lag circuit:	2300 W / max. 140 $\mu$ F



Ref.-no.

**Heating actuator, 6-gang**

Rail mounting device, 4 rail units

6 outputs "TRIAC"

with manual electronic operation and LED status indication

ETS product family: Heating, A/C, Ventilation

Product type: Valve

**2336 REG HZ HE****Intended use**

- Switching of electrothermal actuators for heaters or cooling ceilings
- Installation in distribution boxes on DIN rail according to DIN EN 60715

**Product characteristics**

- Switching operation or PWM operation
- Actuators with characteristics opened or closed without power controllable
- Valve drives for 230 V or 24 V controllable
- Outputs can be operated manually, construction site mode
- Feedback in manual mode and in bus mode
- Disabling of individual outputs manually or by bus
- Overload-protected, short circuit-protected; error indication with LED
- Protection against jamming valves
- Forced position
- Various setpoints for forced position or emergency operation in case of bus failure for summer or winter
- Cyclical monitoring of the input signals can be parameterised
- Feedback via bus, e.g. in case of mains failure, overload or sensor failure

**Technical data**

Rated voltage:	AC 110 ... 230 V ~, 50/60 Hz
Stand-by power:	max. 0.4 W
Power loss:	max. 1 W
Rated voltage KNX:	DC 21 ... 32 V SELV
Power consumption KNX:	max. 250 mW
Ambient temperature:	-5 ... +45 °C
Storage/transport temperature:	-25 ... +70 °C
Heating outputs	
Contact type:	semiconductor (triac), $\epsilon$
Switching voltage:	AC 24 / 230 V ~
Mains frequency:	50 / 60 Hz
Switching current:	5 ... 160 mA
Switch-on current:	max. 1.5 A (2 s)
Switch-off current:	max. 0.3 A (2 min)
Number of drives per output	
230 V drives:	max. 4
24 V drives:	max. 2
Mounting width:	72 mm (4 rail units)
Connection, outputs:	
single wire:	0.5 ... 4 mm <sup>2</sup>
stranded without ferrule:	0.5 ... 4 mm <sup>2</sup>
stranded with ferrule:	0.5 ... 2.5 mm <sup>2</sup>



Ref.-no.

**Heating actuator, 6-gang  
with controller**

Rail mounting device, 4 rail units

6 outputs "TRIAC"

with manual electronic operation and LED status indication

ETS product family: Heating, A/C, Ventilation

Product type: Valve

**2336 REG HZR HE****Intended use**

- Switching of electrothermal actuators for heaters or cooling ceilings
- Installation in distribution boxes on DIN rail according to DIN EN 60715

**Product characteristics**

- Integrated room temperature control with setpoint value specification
- Six independent controllers to control up to six independent rooms
- Controller function for heating and cooling
- Switching operation or PWM operation
- Actuators with characteristics opened or closed without power controllable
- Valve drives for 230 V or 24 V controllable
- Outputs can be operated manually, construction site mode
- Feedback in manual mode and in bus mode
- Disabling of individual outputs manually or by bus
- Overload-protected, short circuit-protected; error indication with LED
- Protection against jamming valves
- Forced position
- Various setpoints for forced position or emergency operation in case of bus failure for summer or winter
- Cyclical monitoring of the input signals can be parameterised
- Feedback via bus, e.g. in case of mains failure, overload or sensor failure

**Technical data**

Rated voltage: AC 110 ... 230 V ~, 50/60 Hz

Stand-by power: max. 0.4 W

Power loss: max. 1 W

Rated voltage KNX: DC 21 ... 32 V SELV

Power consumption KNX: max. 250 mW

Ambient temperature: -5 ... +45 °C

Storage/transport temperature: -25 ... +70 °C

**Heating outputs**Contact type: semiconductor (triac),  $\epsilon$ 

Switching voltage: AC 24 / 230 V ~

Mains frequency: 50 / 60 Hz

Switching current: 5 ... 160 mA

Switch-on current: max. 1.5 A (2 s)

Switch-off current: max. 0.3 A (2 min)

**Number of drives per output**

230 V drives: max. 4

24 V drives: max. 2

Mounting width: 72 mm (4 rail units)

Connection, outputs: screw terminals

single wire: 0.5 ... 4 mm<sup>2</sup>stranded without ferrule: 0.5 ... 4 mm<sup>2</sup>stranded with ferrule: 0.5 ... 2.5 mm<sup>2</sup>



Ref.-no.

**Analogue actuator, 4-gang**

Rail mounting device, 4 rail units

ETS product family: Output

Product type: Analogue output 4-gang

**2204.01 REGA****The analogue output needs 24 V AC for operation.****The necessary power can be supplied by the power supply unit ref.-no.: WSSV 10.**

- The analogue output converts measuring data received via KNX telegrams (DPT-ID 9.0xx and 5.010) into analogue output signals.
- The analogue output signals enable heating, ventilation and air conditioning units to adapt their output values to information received from the bus and thus to take part in control processes.  
Voltage signals: 0 ... 1 V DC 0 ... 10 V DC  
Current signals: 0 ... 20 mA DC 4 ... 20 mA DC
- The analogue output offers four analog outputs which can be software-parameterised for one of the ranges mentioned above. Outputs not used can be deactivated.
- The output variables can be force-controlled from a coordinating control system.
- With an analogue output extension module, the number of analog outputs can be increased from 4 to 8.
- In conjunction with the "dimming" function of a sensor, both, the analogue output and also the analogue output extension module can be used as an active control unit for dimming applications.

## Remarks on the hardware:

- The GND terminals must not be connected to the corresponding terminals of another device.
- The outputs of the analogue output and of the analogue output extension module must not be connected to the 1 ... 10 V interface of electronic ballasts or electronic transformers.
- All connected components must ensure safe separation from other voltages

**Technical data**

## Power supply

Supply voltage: AC 24 V ~ ± 10 %

Current consumption: max. 308 mA

Rated voltage KNX: DC 21 ... 32 V SELV

Power consumption KNX: typical 150 mW

Ambient temperature: -5 ... +45 °C

Storage/transport temperature: -25 ... +70 °C

## Humidity

Ambient/storage/transport: max. 93 % r. h., no condensation

Mounting width: 72 mm (4 rail units)

Weight: approx. 180 g

## Terminals

Outputs, power supply: screw terminals

single wire: 0.5 ... 4 mm<sup>2</sup>stranded without ferrule: 0.5 ... 4 mm<sup>2</sup>stranded with ferrule: 0.5 ... 2.5 mm<sup>2</sup>

KNX: bus connection block

## Analogue outputs

Number: 4

Ranges: 0 ... 1 V, 0 ... 10 V, DC

0 ... 20 mA, 4 ... 20 mA, DC

Voltage signal load: ≥ 1 kW

Current signal load: ≤ 500 W

## Power supply

Analogue actuator module: DC 24 V via system bus

max. 80 mA

Ref.-no.

**Analogue actuator module, 4-gang**

Rail mounting device, 4 rail units

**2204.01 REGAM**

Extension module for analogue actuator 4-gang ref.-no.: 2204.01 REGA

**Function**

- The analogue actuator module extends a KNX analogue actuator 4-gang by four additional sensor outputs.
- The analogue output extension module offers four analogue outputs which can be software parameterised for one of the following ranges.
- Outputs not used can be deactivated.  
Voltage signals: 0 ... 1 V DC 0 ... 10 V DC  
Current signals: 0 ... 20 mA DC 4 ... 20 mA DC

**Technical data**

## Power supply

Supply voltage:	AC 24 V ~ ± 10 %
Current consumption:	max. 120 mA
Current consumption at system	6 mA

## connector:

Ambient temperature:	-5 ... +45 °C
Storage/transport temperature:	-25 ... +70 °C

## Humidity

Ambient/storage/transport: max. 93 % r. h., no condensation

Mounting width: 72 mm (4 rail units)

Weight: approx. 155 g

## Terminals

Outputs, power supply: screw terminals

single wire:	0.5 ... 4 mm <sup>2</sup>
stranded without ferrule:	72 mm (4 rail units)
stranded with ferrule:	0.5 ... 2.5 mm <sup>2</sup>

Connection KNX device: KNX bus connection block

## Analogue outputs

Number:	4
Ranges:	0 ... 1 V DC, 0 ... 10 V DC, 0 ... 20 mA DC, 4 ... 20 mA, DC

Voltage signal load: ≥ 1 kW

Current signal load: ≤ 500 W



# Multistation



## KNX MULTISTATION

Compact device for the distribution

The KNX Multistation combines input and output channels in one compact device. Using logic functions, inter-device connections to the building control system are possible. Functions are combined in one unit that otherwise can only be provided using multiple individual devices – such as lighting, blind and temperature control.

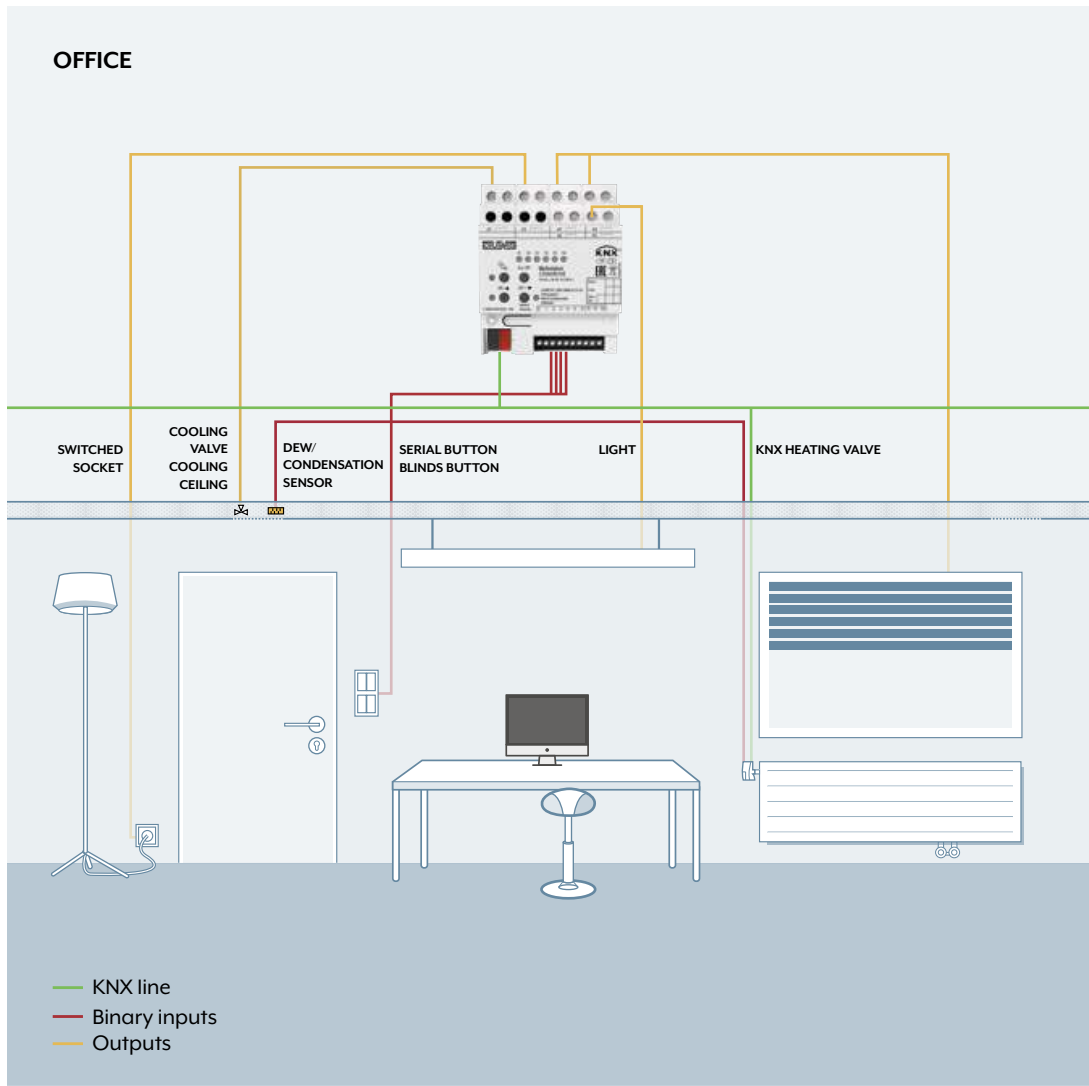

This multitasking building automation device proves itself as a genuine problem solver: Due to its functional depth, the Multistation is ideally suited for quick and cost-efficient equipping, for example, offices, hotels or also hospitals. Only one device per room is needed; the configuration can optionally be made without ETS group addresses and then

easily duplicated for all other rooms. Without additional work. With only 4 TE, the Multistation only requires a little space in the switch cabinet and is thus also ideally suited for retrofitting. And due to the low requirement for power supplies, the costs are of course also lower than for the use of individual switching, dimming and blinds actuators.



Ref.-no.

**Multi station**

Rail mounting device, 4 rail units

**23066 REGHE****Intended use**

- Switching of electrical loads with floating contacts
- Switching of electrically-driven blinds, shutters, awnings and similar hangings
- Switching of electrothermal drives
- Polling of conventional switching or push-button contacts, window contacts etc. in KNX systems, for reporting of states, meter levels, operation of loads, etc.
- Polling of external temperature sensors for heating control
- Logic functions to control building functions
- Mounting on DIN rail according to EN 60715 in distribution boxes

**Product characteristics**

- Actuator functions: switching, blinds, electrothermal drives
- Actuator function can be switched in pairs
- Integrated push-button interface with 6 inputs
- 2 integrated room temperature controllers
- 2 inputs for temperature sensors (ref.-no. FF 7.8)
- Outputs can be operated manually, construction site mode
- Feedback in manual mode and in bus mode
- Scene function
- Disabling of individual outputs manually or by bus

**Switching function**

- Max. 6 switching outputs
- Operation as NO or NC contacts
- Logic operation and forcing function
- Feedback function
- Central switching function with collective feedback
- Time functions: switch-on delay, switch-off delay, staircase lighting timer with pre-warning function

**Blinds function**

- Max. 3 blinds outputs
- Suitable for 230 V AC motors
- Blind/shutter position directly controllable
- Slat position directly controllable
- Feedback of movement status, blind/shutter position and slat position
- Forced position through higher-level controller
- Safety function: 3 independent wind alarms, rain alarm, frost alarm
- Sun protection function

**Function of valve drives**

- Max. 2 outputs for electrothermal drives
- Switching operation or PWM operation
- Actuators with characteristics opened or closed without power controllable
- Emergency operation in case of bus voltage failure for summer and winter
- Protection against jamming valves
- Forced position
- Cyclical monitoring of the input signals can be parameterised

**Heating controller**

- 2 internal controllers to control two independent rooms
- Control for heating or cooling, optionally with additional level
- On-off, PWM or PI control
- Predefined heating types (hot water heating, fan coil unit ...) or individual parameters possible

**Inputs**

- 6 inputs for push-buttons
- Input functions: switching, dimming, blinds control, light scene extension unit, brightness or temperature value transmitter
- 2 inputs for external temperature sensors

**Logic functions**

- Up to 10 logic operations with up to 8 inputs each, e.g. for AND, OR and XOR operations
- Conversion of data point types, e.g. from 1-bit to 8-bit
- Comparative operations, e.g. <, >, ≤, ≥
- Arithmetic functions, e.g. +, -, \*, :

**Technical data ref.-no. 23066 REGHE**

KNX medium:	TP 256
Rated voltage KNX:	DC 21 ... 32 V SELV
Current consumption KNX:	max. 20 mA
Current consumption KNX:	min. 4 mA
Connection, KNX:	terminal
Power loss:	max. 6 W
Ambient temperature:	-5 ... +45 °C
Storage/transport temperature:	-25 ... +70 °C
Relay outputs	
Contact type:	floating relay contacts (μ contact)
Switch type:	make contact
Switching voltage:	AC 250 V ~
Min. switching current AC:	100 mA
Switching current AC1 (cos φ > 0.8):	16 A
Switching current AC3 (cos φ < 0.8):	6 A
Fluorescent lamps:	16 AX
Switch-on current 200 μs:	max. 800 A
Switch-on current 20 ms:	max. 165 A
Switching voltage DC:	DC 12 ... 24 V
Switching current DC 24 V:	6 A
Connected load, 230 V	
Ohmic load:	3000 W
blind / fan motors:	1380 VA
Lamp loads 230 V	
Incandescent lamps:	3000 W
HV halogen lamps:	2500 W
HV LED lamps:	max. 400 W
Electronic transformers:	1500 W
Inductive transformers:	1200 VA
Fluorescent lamps T5/T8	
non-compensated:	1000 W
parallel compensated:	1160 W / 140 μF
lead-lag circuit:	2300 W / 140 μF
Compact fluorescent lamps	
non-compensated:	1000 W
parallel compensated:	1160 W / 140 μF
Mercury vapour lamps	
non-compensated:	1000 W
parallel compensated:	1160 W / 140 μF
Electrothermal valve drives	
Cycle time:	min. 15 min
Connection, load:	
single wire:	screw terminals
stranded without ferrule:	0.5 ... 4 mm <sup>2</sup>
stranded with ferrule:	0.5 ... 4 mm <sup>2</sup>
stranded with ferrule:	0.5 ... 2.5 mm <sup>2</sup>
Inputs	
Rated voltage:	DC 3.3 V SELV
Signal duration:	min. 100 ms
Make contacts:	max. 50
Break contacts:	max. 50
Cable length:	max. 30 m
Connection, inputs:	
single wire:	screw terminals
stranded without ferrule:	0.08 ... 1.5 mm <sup>2</sup>
stranded without ferrule:	0.08 mm <sup>2</sup> ... 1.0 mm <sup>2</sup>
stranded with ferrule:	0.14 mm <sup>2</sup> ... 0.5 mm <sup>2</sup>
stranded with ferrule:	0.14 mm <sup>2</sup> ... 0.5 mm <sup>2</sup>
Mounting width:	72 mm (4 rail units)



# Flush mounting actuators



Small and compact: These features distinguish the KNX flush mounting actuators. Thanks to the flush mounting or installation in trunking etc., they are extremely space-saving with extensive functional depth. They all have multiple, integrated binary inputs.

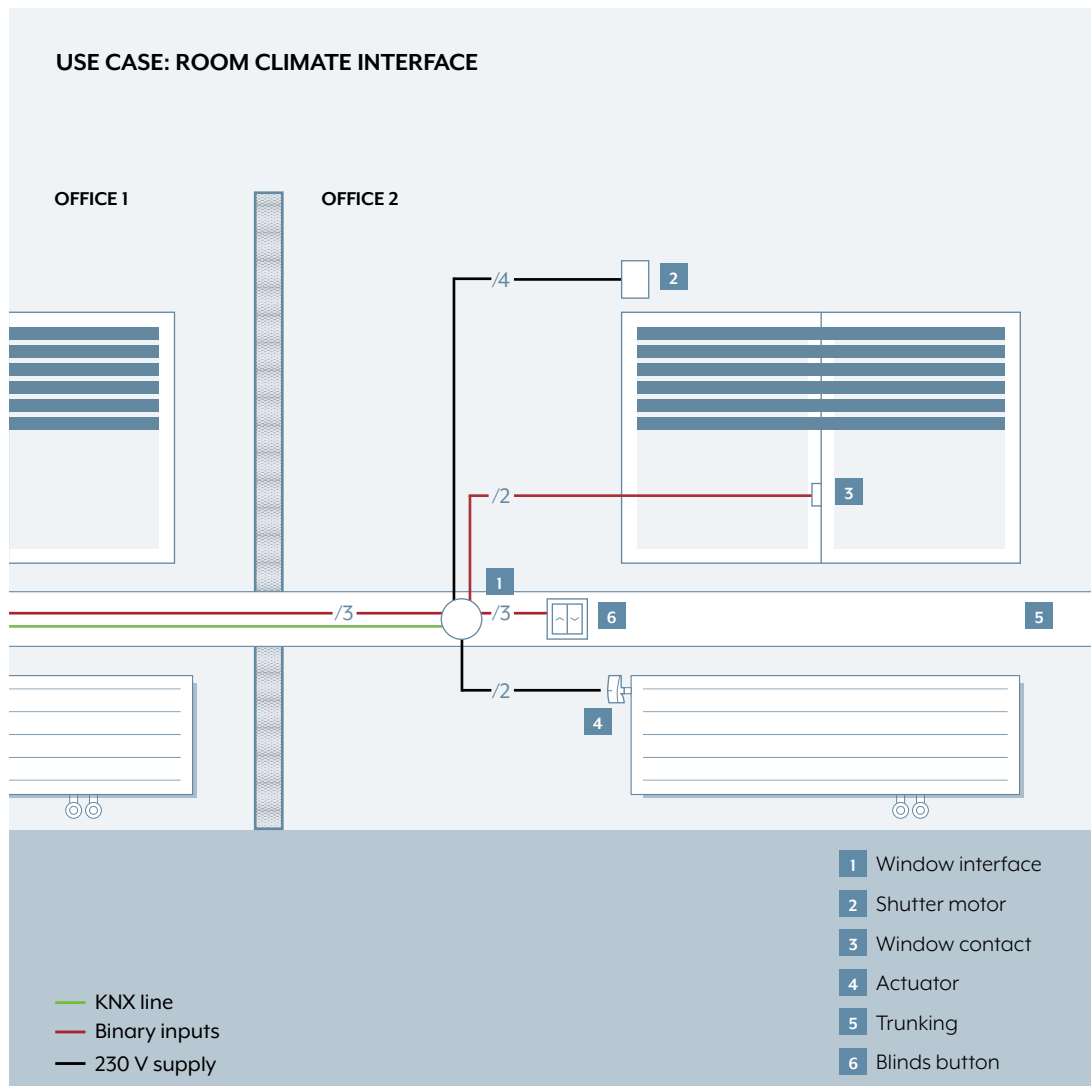

The Room Climate Interface offers one blind/shutter output, one heating output and three binary inputs. On the one hand, the binary inputs of the flush mounting actuators can be used for „local operation“. On the other hand, they are used as extension inputs for the connection of floating contacts e.g. window contacts, whereby the respective range of functions can be expanded at low cost.

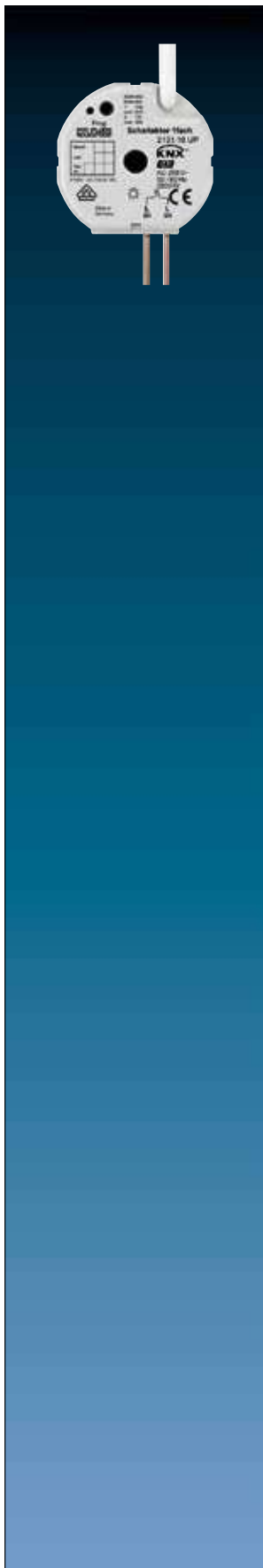

Ref.-no.

### Flush-mounted switch actuator, 1-gang with satellite input

1 make contact, 2 binary inputs  
ETS product family: Output  
Product type: Binary output

2131.16 UP

#### Intended use

- Switching of electrical loads for AC 230 V mains voltage
- Installation in appliance box to DIN 49073
- Connection with enclosed terminals

#### Product characteristics

- Two binary inputs for potential-free contacts, usable as extension inputs for local operation
- Operation as NO or NC contacts
- Feedback function
- An additional function: logical, forced-position or time function
- Time functions: switch-on delay, switch-off delay, staircase lighting timer
- Supply via bus, no additional power supply necessary

#### Technical data

##### Output

Number:	1
Switch type:	floating make contact ( $\mu$ contact)
Max. switching voltage:	AC 230 V ~
Max. switching current:	16 A at 230 V AC
Switching capacity	
Incandescent lamps:	2200 W
HV halogen lamps:	2200 W
Capacitive load:	AC 230 V, 10 A, max. 105 $\mu$ F
Inductive transformers:	1000 VA
Electronic transformers:	1000 W

##### Terminals

Output cable:	L and L', colour brown, 1.5 mm <sup>2</sup> , length approx. 20 cm
Bus and control cable:	KNX + red KNX – black binary input 1 green GND white binary input 2 yellow GND brown length approx. 33 cm, extendible to 5 m max.
Satellite input:	depending on parameterization either as extension inputs for push-button local control of the actuator or as independent binary inputs acting on the bus
Dimensions:	Ø 53 mm, height 28 mm
Approvals:	VDE

Ref.-no.

## Flush-mounted switch actuator, 2-gang with satellite input

2 make contacts, 2 binary inputs  
ETS product family: Output  
Product type: Binary output

2132.6 UP

### Intended use

- Switching of electrical loads for AC 230 V mains voltage
- Installation in appliance box to DIN 49073
- Connection with enclosed terminals

### Product characteristics

- Two binary inputs for potential-free contacts, usable as extension inputs for local operation
- Operation as NO or NC contacts
- Feedback function for each output
- An additional function for each output: logical, forced-position or time function
- Time functions: switch-on delay, switch-off delay, staircase lighting timer
- Supply via bus, no additional power supply necessary

### Technical data

#### Output

Number:	2
Contact type:	floating relay contacts (μ contact)
Switch type:	make contact
Max. switching voltage:	AC 230 V ~
Max. switching current:	2 x 6 A at 230 V AC
Switching capacity	
Incandescent lamps:	1200 W
HV halogen lamps:	1200 W
Capacitive load:	AC 230 V, 6 A, max. 14 μF
Inductive transformers:	500 VA
Electronic transformers:	500 W

#### Terminals

Output cable:	L, L'1, L'2, black, pink, grey, 1.5 mm <sup>2</sup> , length approx. 20 cm
Bus and control cable:	KNX + red KNX - black binary input 1 green GND white binary input 2 yellow GND brown length approx. 33 cm, extendible to 5 m max.
Satellite input:	depending on parameterization either as extension inputs for push-button local control of the actuator or as independent binary inputs acting on the bus
Dimensions:	Ø 53 mm, height 28 mm
Approvals:	VDE



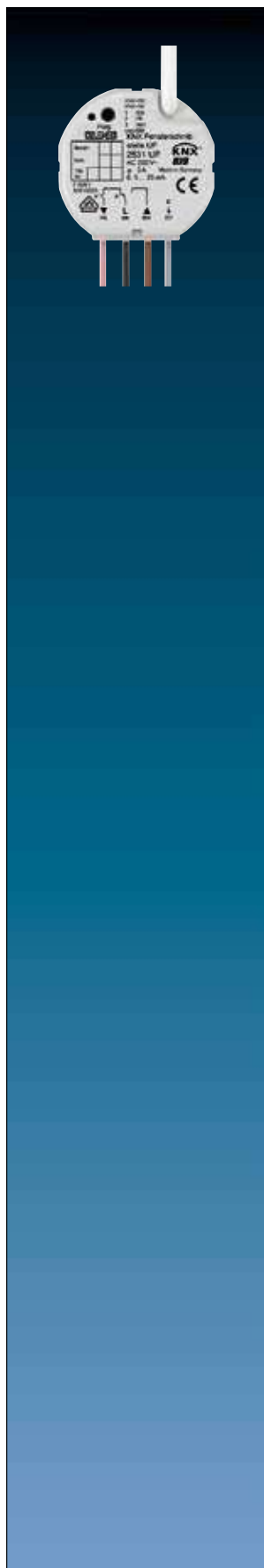

Ref.-no.

### Flush-mounted room climate interface with satellite input

3 binary inputs  
1 blinds output, 1 output "TRIAC" (heating)

2531 UP

#### Intended use

- Switching of electrically-driven blinds, awnings and similar blinds for AC 230 V mains voltage
- Switching of electrothermal actuators
- Installation in appliance box to DIN 49073
- Connection with enclosed terminals

#### Product characteristics

- Control of Venetian blinds, awnings and similar blinds
- Control of electrothermal actuators
- Three binary inputs for potential-free contacts, usable as extension inputs for local operation
- Supply via bus, no additional power supply necessary

#### Blinds function

- Blind position directly controllable
- Slat position directly controllable
- Feedback of movement status, blind position and slat position
- Forced position through higher-level controller
- Safety function: 3 independent wind alarms, rain alarm, frost alarm
- Sun protection function

#### Function of valve drives

- Switching operation or PWM operation
- Valve drives with characteristics opened or closed without power
- Overload-protected, short circuit-protected
- Protection against jamming valves
- Forced position
- Cyclical monitoring of the input signals configurable

**PWM operation:** electrothermal actuators only have the positions Open and Closed. In PWM operation, switch-on and switch-off during the drive's cycle time achieves an almost constant behaviour.

#### Technical data

Rated voltage:	AC 230/240 V ~, 50/60 Hz
Switching voltage:	AC 250 V ~
Ambient temperature:	-5 ... +45 °C
Storage/transport temperature:	-25 ... +70 °C
Blinds output	
Contact type:	μ
Switching current AC1 (cos φ > 0.8):	3 A
Min. switching current AC:	100 mA
Motors (230 V):	600 VA
Heating output	
Contact type:	semiconductor (triac), ε
Switching current:	5 ... 25 mA
Switch-on current:	max. 600 mA (2 s)
Number of drives per output:	max. 2
Control cable:	YY6x0.6
Input type:	floating contact
Total cable length:	max. 5 m
Voltage satellite inputs:	approx. 5 V
Dimensions (Ø x H):	53 x 28 mm
Connection:	screwless terminals
single wire:	1 ... 2.5 mm <sup>2</sup>
KNX supply:	DC 21 ... 32 V SELV
Power consumption KNX:	max. 240 mW
Connection, KNX:	terminal connected to control cable
Approvals:	VDE

Ref.-no.

**Flush-mounted blinds actuator, 1-gang  
with satellite input**

3 binary inputs  
ETS product family: Shutter  
Product type: Shutter

**2501 UP**

**Intended use**

- Switching of electrically-driven blinds, awnings and similar blinds for AC 110 ... 230 V mains voltage
- Installation in appliance box to DIN 49073
- Connection with enclosed terminals

**Product characteristics**

- Control of blinds, awnings and similar blinds
- Three binary inputs for potential-free contacts, usable as extension inputs for local operation
- Supply via bus, no additional power supply necessary
- Blind position directly controllable
- Slat position directly controllable
- Feedback of movement status, blind position and slat position
- Forced position through higher-level controller
- Safety function: 3 independent wind alarms, rain alarm, frost alarm
- Sun protection function

**Technical data**

Rated voltage:	AC 110 ... 240 V ~, 50/60 Hz
Switching voltage:	AC 250 V ~
Ambient temperature:	-5 ... +45 °C
Storage/transport temperature:	-25 ... +70 °C
Blinds output	
Contact type:	μ
Switching current AC1 (cos φ > 0.8):	3 A
Min. switching current AC:	100 mA
Motors (230 V):	600 VA
Motors (110 V):	300 VA
Control cable:	
Input type:	floating contact
Total cable length:	max. 5 m
Voltage satellite inputs:	approx. 5 V
Dimensions (Ø x H):	53 x 28 mm
Connection:	
single wire:	1 ... 2.5 mm <sup>2</sup>
KNX supply:	DC 21 ... 32 V SELV
Power consumption KNX:	max. 240 mW
Connection, KNX:	terminal connected to control cable
Approvals:	VDE

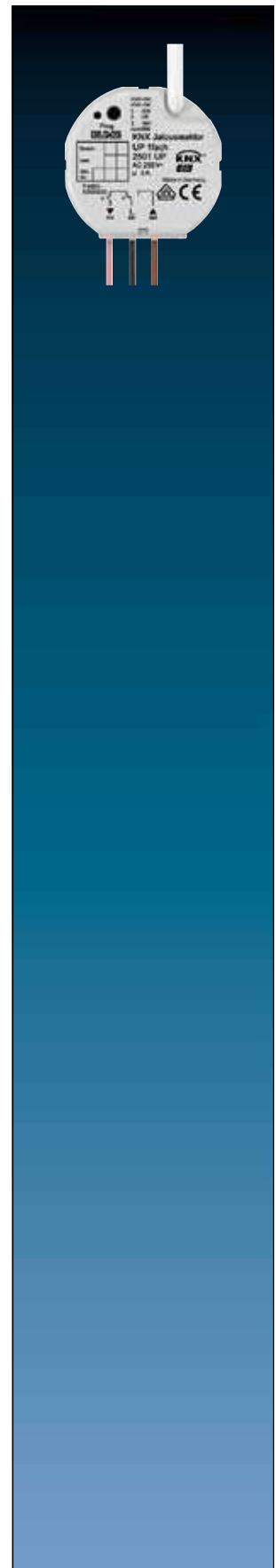

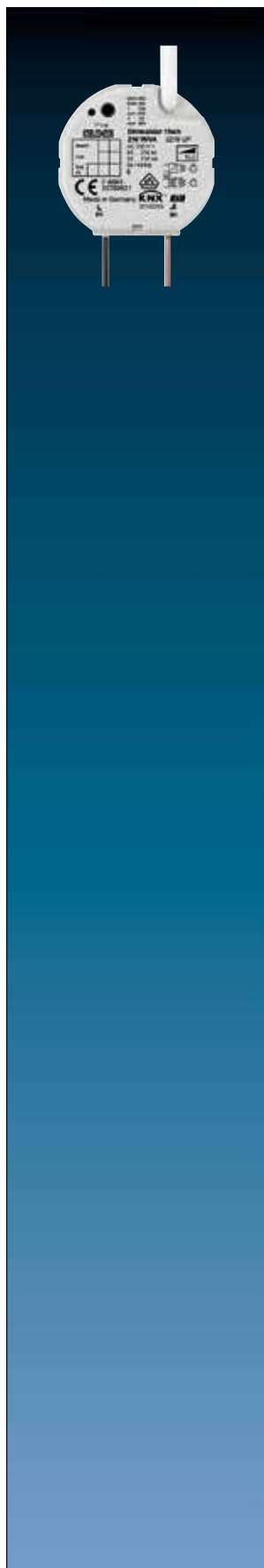

Ref.-no.

**Flush-mounted dimming actuator, 1-gang, 50 – 210 W/VA  
with satellite input**

2 binary inputs

ETS product family: Illumination

Product type: Dimmer

**3210 UP****Intended use**

- Switching and dimming of incandescent lamps, 230 V halogen lamps and LV halogen lamps with inductive transformers or Tronic transformers
- Installation in appliance box to DIN 49073

**Product characteristics**

- Automatic selection of the dimming principle suitable for the load
- Protected against no-load, short-circuit and overheating
- Feedback of the switching position and the dimming value
- Parameterisable switch-on and dimming behaviour
- Timed dimmer: switch-on delay, switch-off delay, staircase lighting timer
- Light scene operation
- Two binary inputs for potential-free contacts, usable as extension inputs for local operation
- Supply via bus, no additional power supply necessary
- Mains failure longer than approx. 0.7 seconds leads to switch-off of the dimmer actuator

**Technical data**

Output:	1 Power MOS-FET
Dimming method:	trailing edge or leading edge phase control
Terminals	
Output cable:	L = black, dimming output = brown, 0.75 mm <sup>2</sup> length approx. 20 cm
Bus and control cable:	KNX + red KNX – black binary input 1 green GND white binary input 2 yellow GND brown length approx. 33 cm, extendible to 5 m max.
Satellite input:	depending on parameterization either as extension inputs for push-button local control of the actuator or as independent binary inputs acting on the bus
Dimensions:	Ø 63 mm, height 25 mm
Rated voltage:	AC 230 V ~, 50/60 Hz
Rated current:	0.9 A
Minimum load:	50 W
Power loss:	2 W
Total connected load:	210 W/VA
Ohmic load:	50 ... 210 W
Incandescent lamps:	50 ... 210 W
HV halogen lamps:	50 ... 210 W
Inductive transformers	
with LV halogen lamps:	50 ... 210 VA
Electronic transformers	
with LV halogen lamps:	50 ... 210 VA
Mix of the specified load types (do not mix capacitive loads with inductive loads). When using mixed loads with inductive transformers, the ohmic load must not exceed 50 %.	
Approvals:	VDE





Ref.-no.

## Flush-mounted heating actuator, 1-gang with satellite input

3 binary inputs

1 output "TRIAC"

ETS product family: Heating, A/C, Ventilation

Product type: Valve

2501 HZ UP

### Intended use

- Switching of electrothermal actuators
- Installation in appliance box to DIN 49073
- Connection with enclosed terminals

### Product characteristics

- Control of electrothermal actuators
- Three binary inputs for potential-free contacts, usable as extension inputs for local operation
- Supply via bus, no additional power supply necessary
- Switching operation or PWM operation
- Actuators with characteristics opened or closed without power
- Overload-protected, short circuit-protected
- Protection against jamming valves
- Forced position
- Cyclical monitoring of the input signals configurable

**PWM operation:** electrothermal actuators only have the positions Open and Closed. In PWM operation, switch-on and switch-off during the drive's cycle time achieves an almost constant behaviour.

### Technical data

Rated voltage:	AC 230/240 V ~, 50/60 Hz
Switching voltage:	AC 250 V ~
Ambient temperature:	-5 ... +45 °C
Storage/transport temperature:	-25 ... +70 °C
Heating output	
Contact type:	semiconductor (triac), ε
Switching current:	5 ... 25 mA
Switch-on current:	max. 600 mA (2 s)
Number of drives per output:	max. 2
Control cable:	YY6x0.6
Input type:	floating contact
Total cable length:	max. 5 m
Voltage satellite inputs:	approx. 5 V
Dimensions (Ø x H):	53 x 28 mm
Connection:	screwless terminals
single wire:	1 ... 2.5 mm <sup>2</sup>
KNX supply:	DC 21 ... 32 V SELV
Power consumption KNX:	max. 240 mW
Connection, KNX:	terminal connected to control cable
Approvals:	VDE

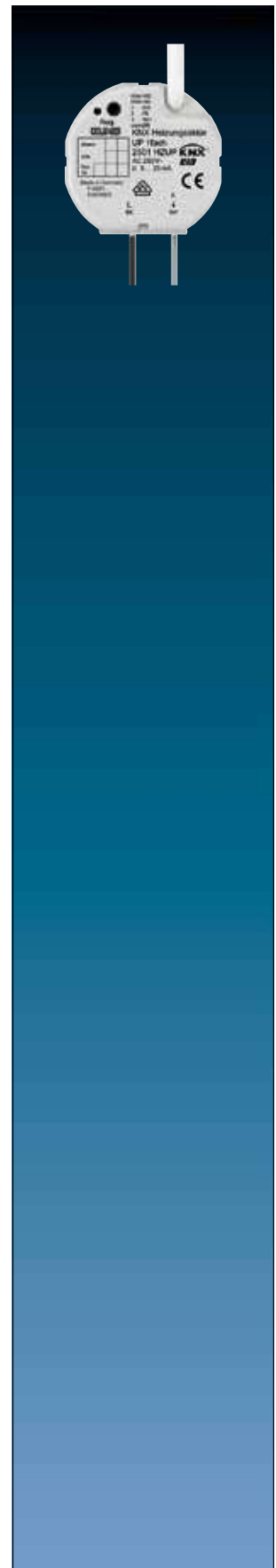

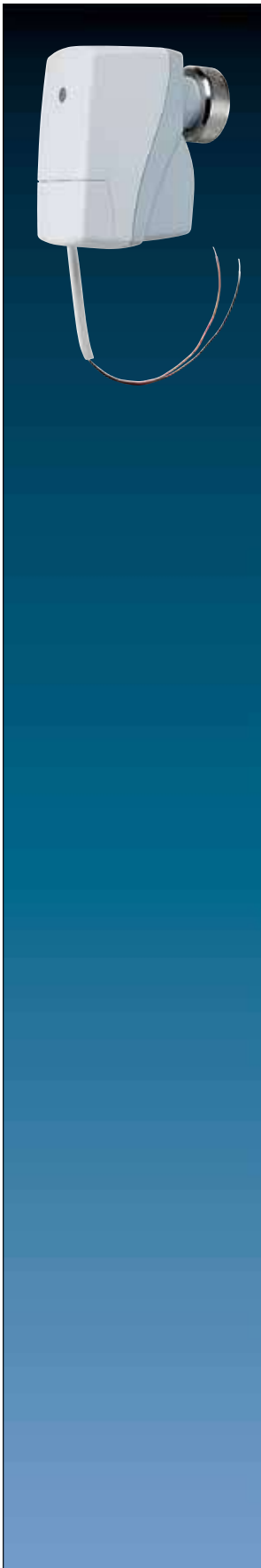

Ref.-no.

**Valve drive (motor-operated)  
with controller**

electromechanical servo drive  
ETS product family: Heating, A/C, Ventilation  
Product type: Valve

**2177 SV R****Intended use**

- Motor-operated valve drive for heating or cooling valves
- To be screwed on valve head

**Product characteristics**

- Integrated temperature sensor
- Room temperature control
- Mechanical indication of valve lift
- Automatic detection of valve lift
- One input, can be used as binary input or for an external temperature sensor (ref.-no.: FF 7.8)
- Use in heating circles possible
- Integrated bus coupling unit
- Valve protection function

**Technical data**

Rated voltage KNX:	DC 21 ... 32 V SELV
Current consumption KNX:	max. 20 mA
Protection class:	III
Valve connection:	M 30 x 1.5
Valve lift:	1.0 ... 4.2 mm
Actuating power:	80 ... 120 N
Dimensions (L x W x H):	76 x 47 x 85 mm
Connection cable	
Cable type:	J-YY 1 x 2 x 0.6 mm
Cable length:	1 m
Total length per line:	max. 30 m
Number of drives per line:	max. 30
Connection cable, binary input/external sensor	
Cable length:	max. 10 m
single wire:	0.08 ... 1.5 mm <sup>2</sup>
stranded without ferrule:	0.08 mm <sup>2</sup> ... 1.0 mm <sup>2</sup>
stranded with ferrule:	0.14 mm <sup>2</sup> ... 0.5 mm <sup>2</sup>
Protection level:	IP 40
Ambient temperature:	0 ... +50 °C
Storage/transport temperature:	-20 ... +70 °C
Relative humidity:	5 ... 95 % (no condensation)

Ref.-no.

**Condensation sensor****BTS 01****Intended use**

- Detection of water condensation on coolant lines in residential or functional buildings
- Connection to KNX push-button interfaces or similar binary inputs
- Fitting on the coolant line

**Technical data**

Rated voltage:	DC 3.3 ... 5 V SELV
Current consumption:	typical 0.5 mA
Short-circuit current:	max. 100 mA
Protection class:	III
Ambient temperature:	0 ... +50 °C
Length of connected cable:	2 m
Protection level:	IP 67

**Leakage sensor****LES 01****Intended use**

- Detection of water penetration and leaks
- Connection to KNX push-button interfaces or similar binary inputs
- Fitting to the surface to be monitored

**Application examples**

- Below or next to the bathtub or shower
- Under the kitchen unit
- Below or behind washing machines
- In boiler rooms
- In supply shafts with water pipes
- In cellar rooms with a risk of backflow
- Below or behind aquariums
- In the heating manifold of floor heating systems

**Technical data**

Rated voltage:	DC 3.3 ... 5 V SELV
Current consumption:	typical 0.5 mA
Short-circuit current:	max. 100 mA
Protection class:	III
Ambient temperature:	0 ... +50 °C
Length of connected cable:	2 m
Protection level:	IP 67

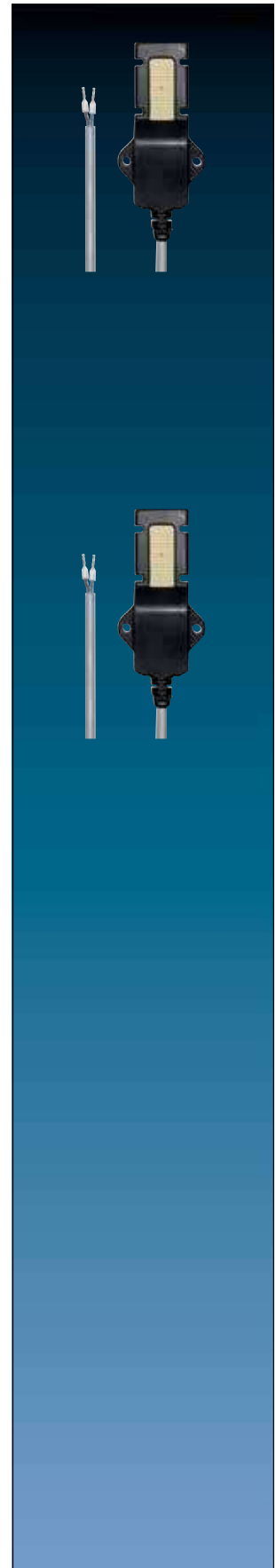



Ref.-no.

**Binary input, 6-gang**

Rail mounting device, 2 rail units

6 inputs AC/DC 10 ... 230 V ~

(different L conductors possible, e.g.: E1-3 = L1 and E4-E6 = L2)

with status indicator

ETS product family: Input

Product type: Binary input

**2116 REG****Intended use**

- Polling of conventional switching or push-button contacts, window contacts etc. in KNX systems, for reporting of states, operation of loads, etc.
- Mounting on DIN rail according to EN 60715 in distribution boxes

**Product characteristics**

- Status LED for each input
- Evaluation of voltage levels and changes at the input
- Transmitting of input status to the bus
- Transmitting behaviour adjustable
- Functions: switching, dimming, blinds up/down, brightness values, temperatures, calling up and saving light scenes, etc.
- Impuls and switch counter function
- Inputs can be blocked separately
- Connection of external AC or DC voltages

**Technical data**

Rated voltage KNX:	DC 21 ... 32 V SELV
Current consumption KNX:	max. 7.5 mA
Connection, KNX:	terminal
Ambient temperature:	-5 ... +45 °C
Storage/transport temperature:	-25 ... +75 °C
Relative humidity:	max. 93 % r. h., no condensation
Inputs	
Rated voltage:	AC/DC 10 ... 230 V
Signal level "0" signal:	AC/DC 0 ... 2 V
Signal level "1" signal:	AC/DC 7 ... 265 V
Input current at rated voltage:	approx. 0.7 mA
Rated frequency AC signal:	30 ... 60 Hz
Signal duration pulse counter:	min. 100 ms
Cable length:	max. 100 m
Number of contacts per input	
Make contacts:	max. 50
Break contacts:	max. 50
Mounting width:	36 mm (2 rail units)
Power loss:	max. 1 W
Connection:	screw terminals
single wire:	0.5 ... 4 mm <sup>2</sup>
stranded without ferrule:	0.5 ... 4 mm <sup>2</sup>
stranded with ferrule:	0.5 ... 2.5 mm <sup>2</sup>

Ref.-no.

**Binary input, 8-gang**

Rail mounting device, 4 rail units

8 inputs 12 ... 48 V AC/DC

Auxiliary voltage output DC 24 V (SELV) for polling potential-free contacts with status indicator

ETS product family: Input

Product type: Binary input

**2128 REG****Product characteristics**

- Status LED for each input
- Detection of voltage levels and changes on the input
- Transmitting the input state to the bus
- Transmission behaviour freely settable
- Functions: switching, dimming, blinds up/down, brightness values, temperatures, calling up and saving scenes
- Inputs can be disabled separately
- External AC and DC voltages can be connected
- Auxiliary voltage output for polling potential-free contacts
- No separate power supply required
- Separate reference potentials for inputs
- Pulse counter (firmware version V02 or higher), also suitable for S0 pulses

**Technical data**

Rated voltage KNX:	DC 21 ... 32 V SELV
Power consumption KNX:	max. 350 mW
Stand-by:	max. 200 mW
Connection, KNX:	terminal
Ambient temperature:	-5 ... +45 °C
Storage/transport temperature:	-25 ... +70 °C
Inputs	
Rated voltage:	AC/DC 12 ... 48 V
Signal level "0" signal:	AC/DC -48 ... +2 V
Signal level "1" signal:	AC/DC 8 ... 48 V
Input current at rated voltage:	2 mA
Signal duration:	min. 30 ms
Rated frequency AC signal:	30 ... 60 Hz
Number of contacts per input	
Make contacts:	unlimited
Break contacts:	max. 20
Output voltage:	DC 24 V SELV
Mounting width:	72 mm (4 rail units)
Stand-by power:	max. 200 mW
Power loss:	max. 1 W
Connection:	screw terminals
single wire:	0.2 ... 4 mm <sup>2</sup>
stranded without ferrule:	0.34 ... 4 mm <sup>2</sup>
stranded with ferrule:	0.14 ... 2.5 mm <sup>2</sup>
Cable length:	max. 100 m



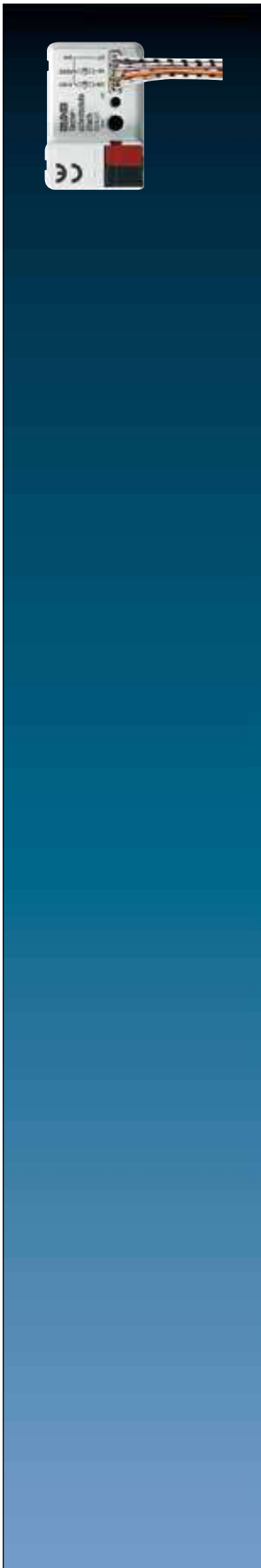

Ref.-no.

**Push-button interface, 2-gang**

ETS product family: Input

Product type: Binary input

**2076-2 T**

- Can be used as binary input
- Can be used as switching output, e.g. for LEDs, max. 0.8 mA

**Technical data**

## Inputs

Number:	2
Signal voltage:	5 V
Signal current:	> 1 mA
Connection:	branching terminal, 5 pins
Length of input cable:	25 cm prefabricated, extendable to 5 m max

## Outputs

Output voltage:	5 V with outputs open circuit (ballast resistor 3.9 k $\Omega$ )
Output current:	2 mA for red low-current LED (at approx. 1.4 V)
Dimensions (W x H x D):	28 x 43 x 16 mm

Ref.-no.

**Push-button interface, 4-gang**

ETS product family: Input

Product type: Binary input

**2076-4 T**

- Can be used as binary input
- Can be used as switching output, e.g. for LEDs, max. 0.8 mA

**Technical data**

## Inputs

Number:	4
Signal voltage:	5 V
Signal current:	> 1 mA
Connection:	branching terminal, 5 pins
Length of input cable:	25 cm prefabricated, extendable to 5 m max

## Outputs

Output voltage:	5 V with outputs open circuit (ballast resistor 3.9 k $\Omega$ )
Output current:	2 mA for red low-current LED (at approx. 1.4 V)
Dimensions (W x H x D):	28 x 43 x 16 mm





# Energy sensor



## KNX ENERGY SENSOR

Measurement and monitoring of energy consumption

The KNX energy sensor can also be retrofitted into already existing KNX systems and has three channels for connecting consumers. For each channel, the voltage, current, effective power and reactive power can be measured: these data are then sent cyclically to the KNX bus for evaluation and visualisation and when any changes occur.

## APPLICATION EXAMPLE

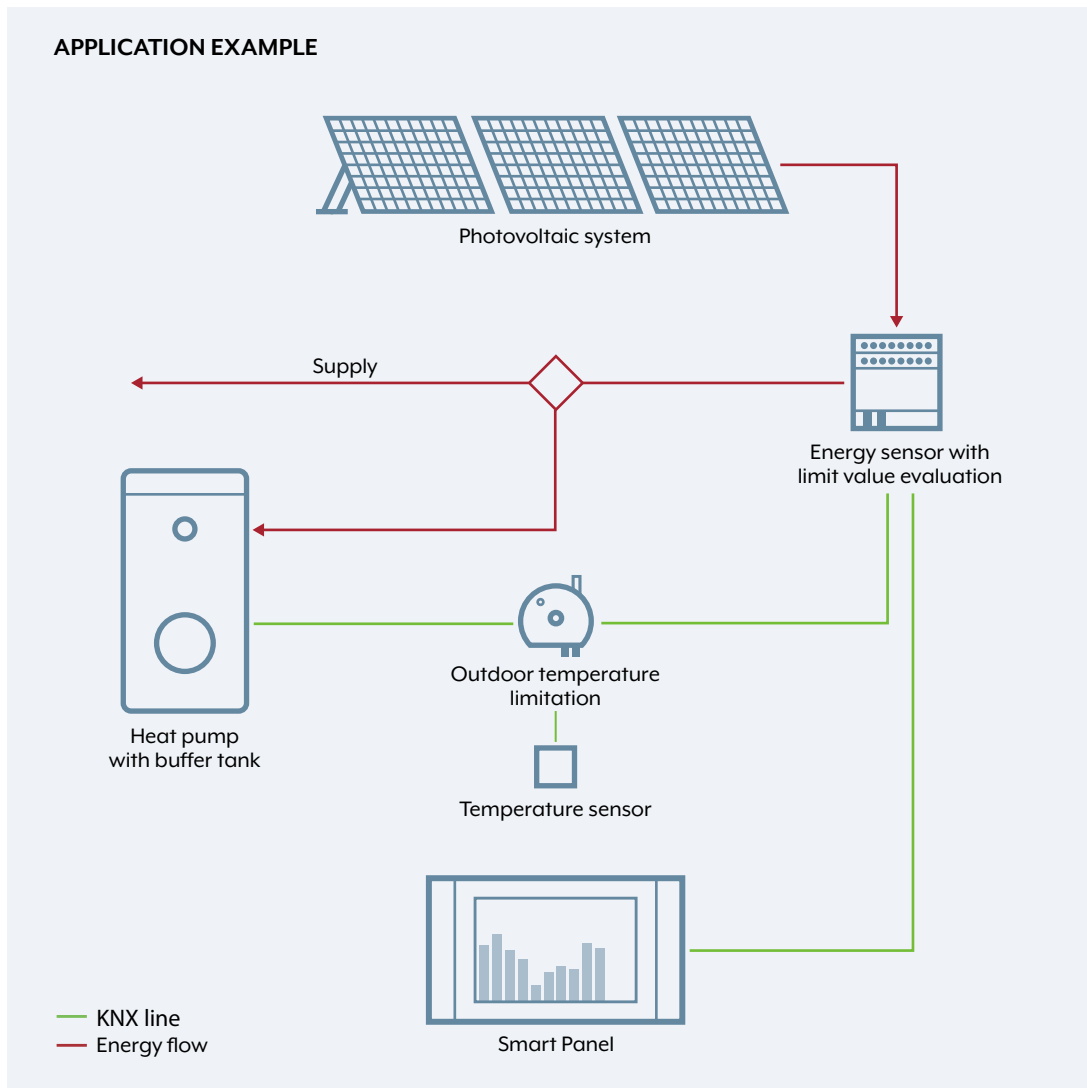

The energy sensor has been expanded with the „converter measurement“ function using optimised software. As well as the three electrical circuits up to 16 Amp to date, it can now also measure the complete building consumption or commercial consumers up to 75 amperes using converters. The sensor records both consumption and supply.

Visualisation of the received data and energy monitoring is performed on the JUNG KNX smart displays or smart devices. Here the values can be stored over months and years and portrayed with clear graphics and statistics. This enables users to identify any possible savings potentials at a glance and to optimise their deployment of energy accordingly.

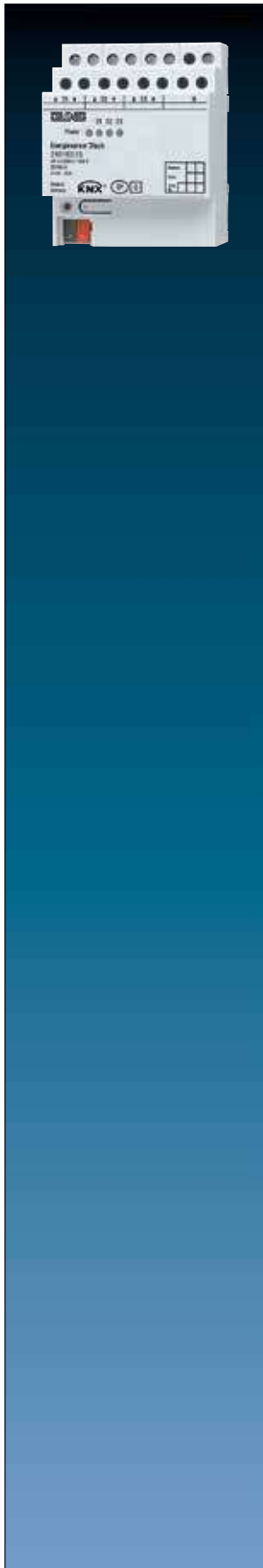

Ref.-no.

**Energy detector, 3-gang, for rail mounting**

Rail mounting device, 4 rail units

ETS product family: Physical sensors

Product type: Energy detector

**2103 REG ES****Product characteristics**

The energy detector has three channels for connecting loads to up to three separate phases with a common neutral conductor. Each channel can measure:

- Voltage (eff.)
- Current (eff.)
- Active power
- Reactive power

Additionally, the active power and reactive power of all channels will be summed up and displayed as three-phase power values along with the mains frequency.

According to the parameterisation the measured values will be transmitted on the KNX bus, either cyclically and / or when the value changes. An additional telegram will be transmitted if certain values exceed or fall below a specified limit.

The following meters exist for each channel and for the three-phase values:

- 1 x energy meter total
- 1 x energy meter ¼ h value
- 3 x energy meter n
- 3 x energy intermediate meter n

**New in version 01:**

- Direct measurement (without transformer)
- Transformer measurement (with external 75 A transformer, ratio 75:5, e.g. Phoenix Contact order key 2277611)

**Technical data ref.-no. 2103 REG ES**

Power supply via E1/N	
Rated voltage:	AC 110 ... 240 V ~
Mains frequency:	50 / 60 Hz
Power consumption:	max. 2 W
Inputs E1 ... E3	
Rated voltage range:	AC 85 ... 265 V ~
Rated current range:	4 mA ... 16 A
Rated frequency:	50 / 60 Hz
Measurands:	voltage (rms value) current (rms value) frequency active power (signed +/-) reactive power (signed +/-) active energy (signed +/-)
External transformer	
Transformation ratio:	75:5
Secondary current:	0 ... 5 A
Accuracy:	
Direct measurement (without transformer):	1 % of 200 mA ... 16 A
Transformer measurement (75 A transformer, class 1):	2 % of 7.5 A ... 75 A
Pulses LED:	
Direct measurement (without transformer):	6400 / kWh
Transformer measurement (75 A transformer):	427 / kWh
Pulse duration:	4.9 ms
Power loss	
Voltage measurement:	≤ 0.03 W / phase
Current measurement:	≤ 0.8 W / phase
Power consumption from mains:	< 1 W
Connection:	
single wire:	0.5 ... 2.5 mm <sup>2</sup>
stranded without ferrule:	0.5 ... 2.5 mm <sup>2</sup>
stranded with ferrule:	0.5 ... 2.5 mm <sup>2</sup>
Ambient temperature:	-5 ... +45 °C
Storage/transport temperature:	-25 ... +70 °C
Mounting width:	72 mm (4 rail units)
KNX medium:	TP 256
Rated voltage KNX:	DC 21 ... 32 V SELV
Current consumption KNX:	max. 5 mA
Connection, KNX:	terminal



# Multiroom amplifier

Central unit for audio distribution: The KNX Multiroom amplifier in its 19" rack housing routes the stereo sound from four sources to up to eight stereo loudspeaker outputs.



Sixteen radio stations can be selected using the integrated web radio. The MP3 player plays music data from the SD card that can be inserted into the integrated SD card reader. New music data can be transferred via FTP to the card at any time. Low-frequency (cinch) inputs for possible playback devices such as Hi-Fi system, DVD player and computer, etc. are available for the connection of other sources. Practical: Only the loudspeaker wiring is required in an existing KNX system.

## EASY OPERATION USING KNX SENSORS



## SYSTEM DESIGN

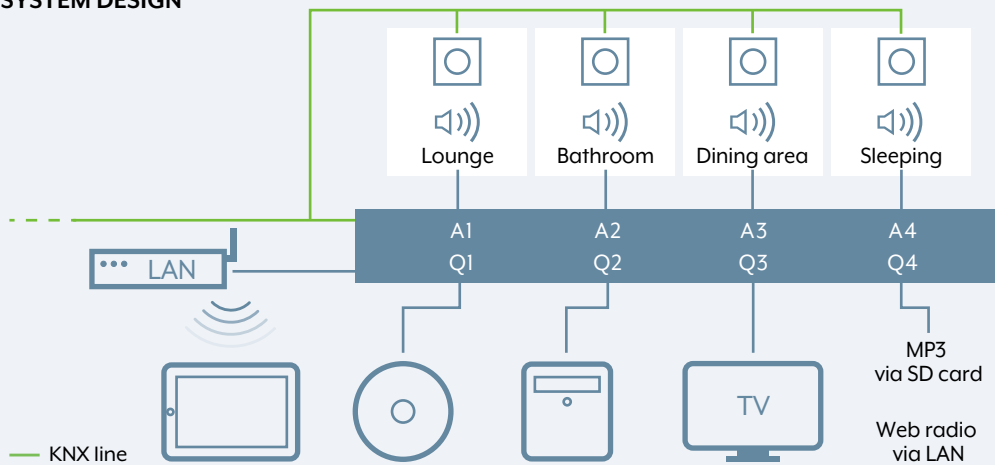

The multiroom amplifier including web radio and MP3 player is operated via the KNX system, together with room functions such as lighting and temperature. The volume is controlled using a rotary sensor; the source selection is made using push-button sensor. Through the OLED graphic display of the connected room controller, the title, artist

and album or radio station are displayed on a scrolling text. The multiroom control can also be optionally performed using a web interface. As well as title selection and volume control etc., the desired zone can also be selected using this. Displaying the cover artwork of the selected album is an additional feature.





**JUNG**  
MULTIROOM AMP

VOLUME BASS TREBLE MUTE

CHANNEL ROUTING

STATUS 1 3 5 7 9 11 13 15 17 19 21 23 25  
SPEED 2 4 6 8 10 12 14 16 18 20 22 24 26

Ref.-no.

**KNX Multiroom amplifier  
with web radio and integrated MP3 player  
with integrated BCU**

**4 outputs stereo**

housing made for the installation into 19" racks

ETS product family: Multimedia

Product type: Multiroom

MR WR-AMP 4.4

**Intended use**

• Sound exposure of various building zones • Fixed installation in interior areas • For mounting in 19" rack systems IEC 60297

**Product characteristics**

• Operation via KNX or via buttons on the front of the device • Audio matrix with integrated amplifiers  
• Independent sound exposure of 4 zones • 4 stereo inputs (AF signal) • 4 loudspeaker outputs stereo  
• 2 stereo outputs (AF signal) • Expandable due to modular structure • Integrated bus coupling unit  
• Status indicator • LAN connection RJ45 (10/100 Mbit/s) • Web radio • 16 radio stations can be accessed directly (KNX object) • Configuration of radio stations via web frontend • Integrated card reader for SD cards (max. 8 GB / FAT32) • SD card can be exchanged • Integrated MP3 player for music files on the SD card  
• New music files can be transferred to the SD card via FTP • Up to 16 folders with max. 250 tracks each  
• Functions such as Switch radio station, Choose title, Stop, Pause etc. are already included • Feedback of media information (artist, title etc.) directly into the KNX system (14 byte) • Web radio and integrated MP3 player can be fully operated via KNX (only web radio and MP3 player can be streamed)

**Technical data**

Rated voltage:	AC 110 ... 230 V ~, 50/60 Hz
Fuse:	
rear side of the device:	T1.0A
top side of the device:	T10A
Connection:	power outlet acc. to IEC 60320-C13
Power consumption:	
110 V:	approx. 181 W
230 V:	approx. 177 W
Stand-by 110 V:	approx. 5 W
Stand-by 230 V:	approx. 6 W
Ambient temperature:	0 ... +45 °C
Number of audio inputs (AF):	4
Number of audio outputs (AF):	2
Connection mode (AF):	cinch (RCA) sockets
Number of loudspeaker outputs (pairs):	4
Frequency range:	30 Hz ... 21 kHz
Total harmonic distortion:	0.2 %
Nominal power output per zone:	30 W (2 x 15 W)
Loudspeaker:	
Permissible load:	min. 30 W
Impedance:	8 Ohm
Connection mode:	screw terminals
stranded without ferrule:	0.75 ... 2.5 mm <sup>2</sup>
KNX:	
Rated voltage:	DC 21 ... 32 V SELV
Connection bus:	Hartmann/PTR BU 9502
Current consumption:	max. 9 mA
Dimensions (W x H x D):	483 x 44.5 x 230 mm



Ref.-no.

**KNX Multiroom amplifier  
with web radio and integrated MP3 player  
with integrated BCU  
8 outputs stereo**

housing made for the installation into 19" racks

ETS product family: Multimedia

Product type: Multiroom

**MR WR-AMP 4.8****Intended use**

• Sound exposure of various building zones • Fixed installation in interior areas • For mounting in 19" rack systems IEC 60297

**Product characteristics**

• Operation via KNX or via buttons on the front of the device • Audio matrix with integrated amplifiers  
• Independent sound exposure of 8 zones • 4 stereo inputs (AF signal) • 8 loudspeaker outputs stereo  
• 2 stereo outputs (AF signal) • Expandable due to modular structure • Integrated bus coupling unit • Status indicator • LAN connection RJ45 (10/100 Mbit/s) • Web radio • 16 radio stations can be accessed directly (KNX object) • Configuration of radio stations via web frontend • Integrated card reader for SD cards (max. 8 GB / FAT32) • SD card can be exchanged • Integrated MP3 player for music files on the SD card  
• New music files can be transferred to the SD card via FTP • Up to 16 folders with max. 250 tracks each  
• Functions such as Switch radio station, Choose title, Stop, Pause etc. are already included • Feedback of media information (artist, title etc.) directly into the KNX system (14 byte) • Web radio and integrated MP3 player can be fully operated via KNX (only web radio and MP3 player can be streamed)

**Technical data**

Rated voltage:	AC 110 ... 230 V ~, 50/60 Hz
Fuse:	
rear side of the device:	T2.0A
top side of the device:	T10A
Connection:	power outlet acc. to IEC 60320-C13
Power consumption:	
110 V:	approx. 397 W
230 V:	approx. 391 W
Stand-by 110 V:	approx. 5.5 W
Stand-by 230 V:	approx. 6 W
Ambient temperature:	0 ... +45 °C
Number of audio inputs (AF):	4
Number of audio outputs (AF):	2
Connection mode (AF):	cinch (RCA) sockets
Number of loudspeaker outputs (pairs):	8
Frequency range:	30 Hz ... 21 kHz
Total harmonic distortion:	0.2 %
Nominal power output per zone:	30 W (2 x 15 W)
Loudspeaker:	
Permissible load:	min. 30 W
Impedance:	8 Ohm
Connection mode:	screw terminals
stranded without ferrule:	0.75 ... 2.5 mm <sup>2</sup>
KNX:	
Rated voltage:	DC 21 ... 32 V SELV
Connection bus:	Hartmann/PTR BU 9502
Current consumption:	max. 9 mA
Dimensions (W x H x D):	483 x 44.5 x 230 mm







KNX ROOM CONTROLLER OLED



# KNX Sonos Gateway



## **KNX SONOS GATEWAY**

Integrating the Sonos sound system in KNX

This gateway connects the intelligent KNX technology to the Sonos multiroom sound. Using various controls or smart devices, up to 30 Sonos devices can be controlled – together with room functions such as lighting, shading and temperature. The operation of the rooms is then optionally performed individually or in parallel using the party mode.

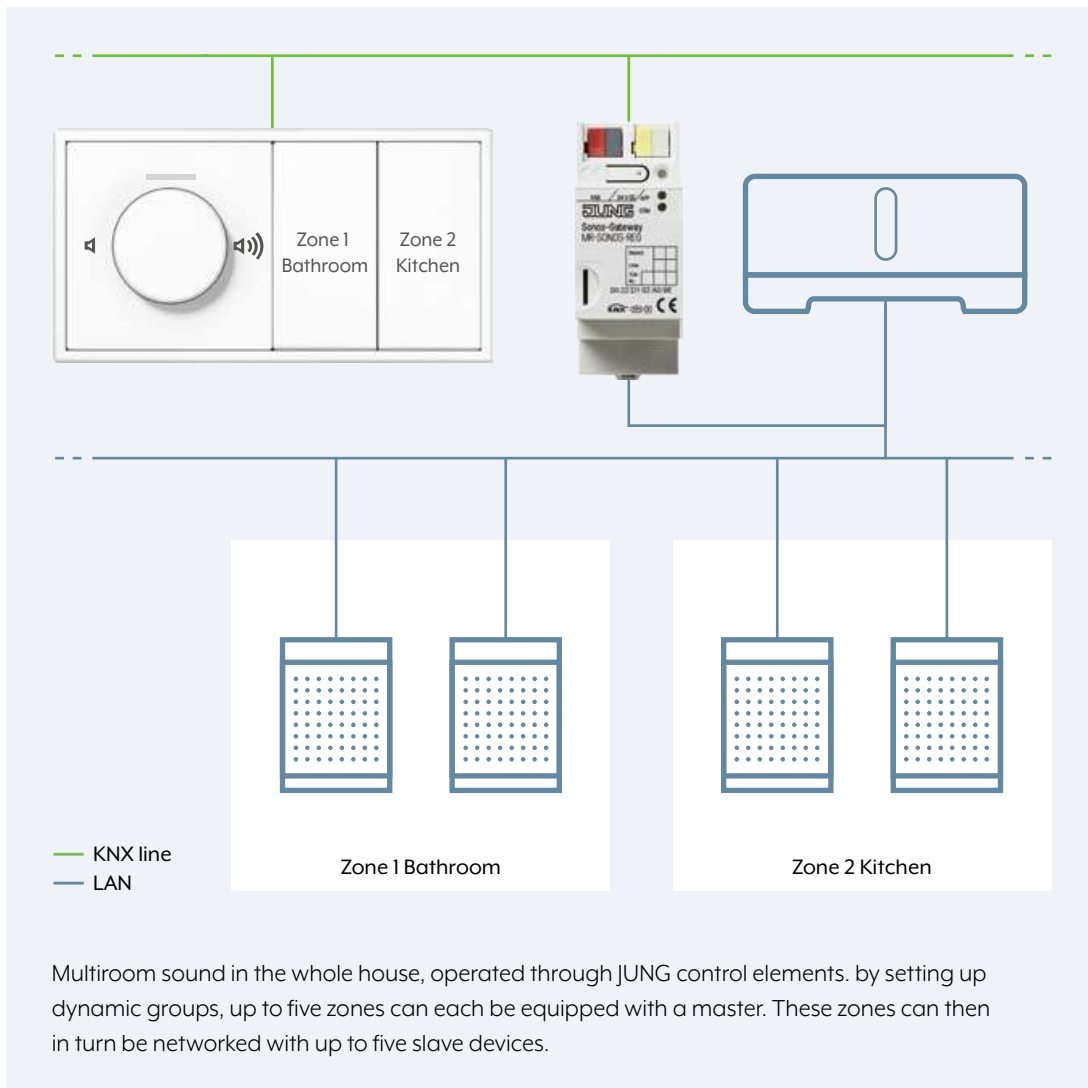

Volume control, title selection, start/stop etc.: Intuitively controlled using KNX sensors or smart phone / tablet in connection with Smart Visu Server. Title, interpret and album are also shown on the displays of room controllers or smart devices. For even greater music enjoyment, playing back music on a micro SD card is also possible in the KNX Sonos Gateway (not included in the scope of delivery).

Ref.-no.

**Sonos gateway**

Rail mounting device, 2 rail units

ETS product family: Multimedia

Product type: Multiroom

**MR-SONOS-REG****Intended use**

- Controlling of Sonos audio devices via KNX
- Mounting on DIN rail according to EN 60715 in distribution boxes

**Product characteristics**

- Control of up to 30 Sonos devices via KNX devices, independent of the Sonos App
- Dynamic group creation of up to five zones with one master and five slave devices each via KNX objects
- Party mode: same music for all rooms
- Volume control for master, slaves and the whole group
- Control of play lists
- Playing music from microSD card (not included) in the Sonos gateway
- Title, artist and album on KNX text objects
- Integrated data network switch with two RJ45 terminals
- Requires ETS version 4.2 or 5.0.2 or higher

**Technical data**

External supply

Rated voltage: DC 24 ... 30 V  $\pm$  10 %

Connection: connecting terminal yellow/white

Power consumption: typical 2 W (at DC 24 V, two Ethernet cables connected)

IP communication: Ethernet 10/100 BaseT (10/100 Mbit/s)

IP connection: 2 x RJ45

Protocols: ARP, ICMP, IGMP, UDP/IP, DHCP, AutoIP,  
KNXnet/IP (Core, Device Management)

Memory card: max. 32 GB microSDHC

Ambient temperature: 0 ... +45 °C

Storage/transport temperature: -25 ... +70 °C

Mounting width: 36 mm (2 rail units)

Rated voltage KNX: DC 21 ... 32 V SELV

Connection, KNX: bus connection block (red/black)





# Universal weather station



**KNX UNIVERSAL WEATHER STATION**  
Compact design, precise measurement

All important sensors for recording and evaluation of meteorological data combined in compact design: the JUNG KNX weather station for weather-dependent automatic shading control for façade protection.

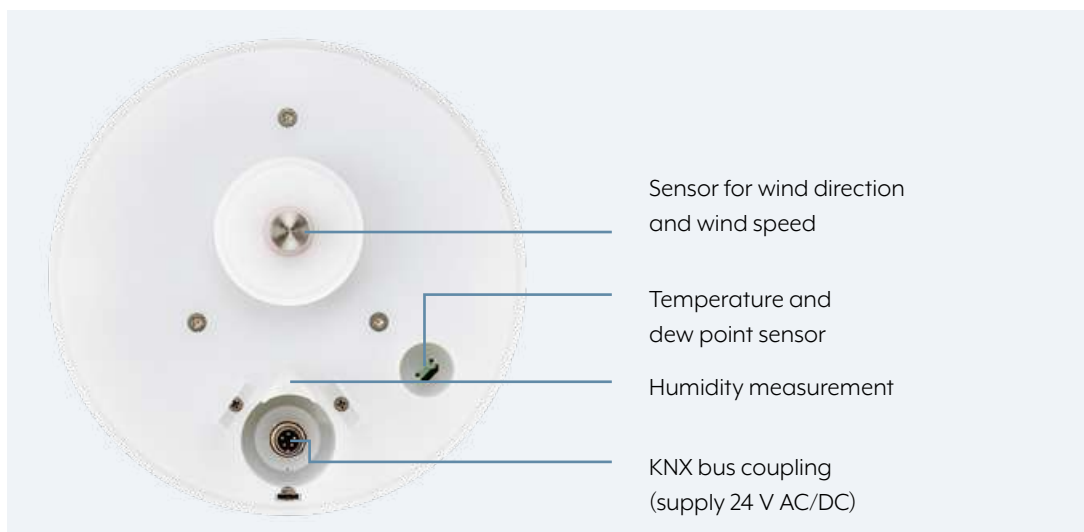
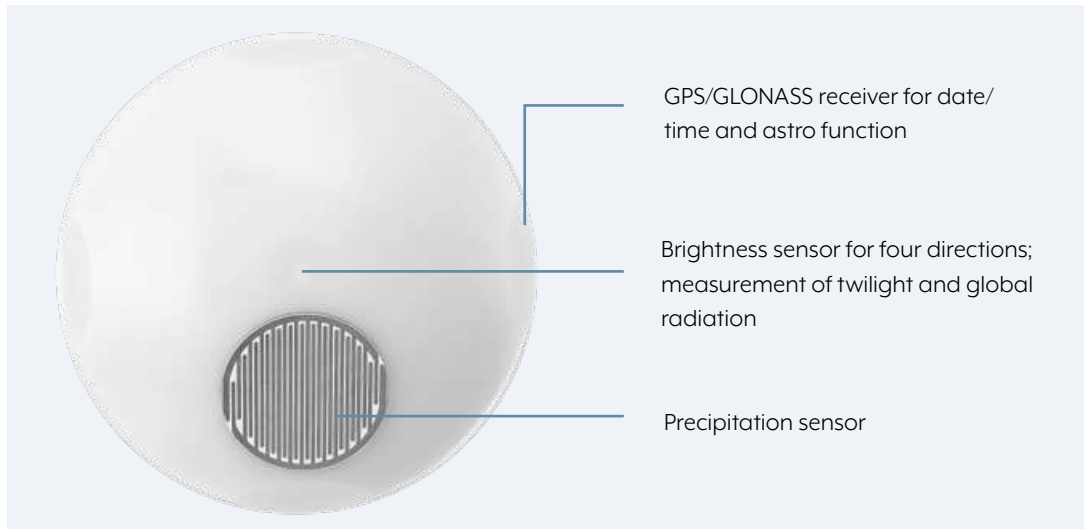

Wind speed, wind direction, brightness in four directions, twilight, global radiation, precipitation, relative air humidity and air pressure are measured using the integrated sensors. The calculation of further data such as absolute humidity and perceived temperature is also carried out. Operating interdependently with each other, values are also determined in terms of the mugginess curve and comfort characteristic that can then be used to optimise the ventilation control.

These features are enhanced with a GPS/GLONASS receiver for the date and time and an astro function for determining the position of the sun. This makes it no-longer necessary to set the time manually. The installation of the weather station is carried out with its own fastening arm on the installation mast. This ensures the best capture and measurement of the weather data. The weather station can also be mounted onto the façade by means of the fastening arm.

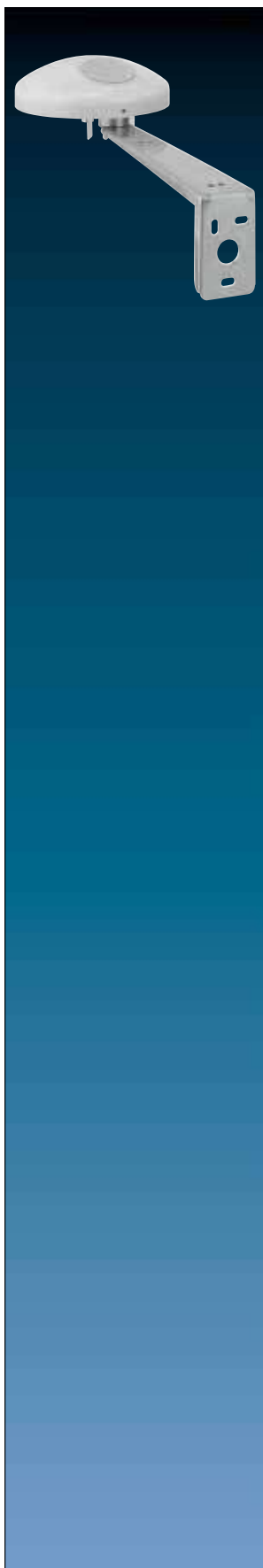

Ref.-no.

**KNX universal weather station**

compact housing  
including fastening arm  
ETS product family: Input  
Product type: Analogue input 4-gang

**2225 WS U****Intended use**

- Measurement and evaluation of weather data: wind speed, wind direction, precipitation, brightness, global radiation, twilight, temperature, relative air humidity and air pressure
- Installation on the outside of buildings, preferable in the roof and facade area
- Operation with additional power supply (ref.-no.: WSSV 10)

**Product characteristics**

- Integrated GPS/GLONASS receiver for automated positioning
- Calculation of additional weather data: absolute air humidity, chill temperature, comfort
- Function for shading control
- Integrated KNX bus coupling unit
- Measuring and limit value monitoring
- Software logic modules for linking events
- Integrated heating

**The weather station needs an operating voltage supply of 24 V AC,  
for example power supply module ref.-no. WSSV 10.**

**Technical data**

Power supply	
Rated voltage:	AC 24 V SELV ( $\pm 10\%$ ) DC 21 ... 32 V SELV
Current consumption:	100 ... 400 mA (dependent on the weather)
Protection class:	III
Cable type:	LiYCY 4xAWG26
Cable length:	5 m
Total length per line:	15 m
Number of weather stations:	max. 3 (per line)
Rated voltage KNX:	DC 21 ... 32 V SELV
Current consumption KNX:	max. 5 mA
Ambient temperature:	-30 ... +60 °C
Storage/transport temperature:	-25 ... +70 °C
Protection level:	IP 44 (in position for use)
Dimensions ( $\varnothing$ x H):	130 x 68 mm
Wind direction sensor	
Measuring range:	1 ... 360°
Resolution:	1°
Accuracy:	$\pm 10\%$ (laminar wind stream)
Wind speed sensor	
Measuring range:	approx. 0 ... 40 m/s
Resolution:	0.1 m/s
Accuracy ( $\leq 10$ m/s):	$\pm 1$ m/s
Accuracy ( $> 10$ m/s):	$\pm 5\%$
Temperature sensor	
Measuring range:	-30 ... +60 °C
Resolution:	0.1 K
Accuracy:	$\pm 1$ K (wind $> 2$ m/s, for -5 ... +25 °C)
Precipitation sensor	
Measuring range:	yes / no
Accuracy:	fine drizzle

---

## Continue Technical data ref.-no. 2225 WS U

Brightness sensors	
Number:	4
Measuring range:	approx. 0 ... 150 klx
Resolution:	1 klx
Accuracy:	± 3 %
Spectral range:	475 ... 650 nm
Dawn sensor	
Measuring range:	approx. 0 ... 900 lx
Resolution:	1 lx
Accuracy:	± 10 lx
Air pressure sensor	
Measuring range:	300 ... 1100 hPa
Resolution:	0.01 hPa
Accuracy:	± 0.5 hPa (20 °C)
Humidity sensor	
Measuring range:	0 ... 100 % relative humidity (r. h.)
Resolution:	0.1 % relative humidity (r. h.)
Accuracy:	± 10 % rel. humidity (20 °C)
Absolute humidity:	0 ... 400 g/m <sup>3</sup>
Resolution:	0.01 g/m <sup>3</sup>
Global radiation	
Measuring range:	0 ... 1300 W/m <sup>2</sup>
Resolution:	1 W/m <sup>2</sup>
Accuracy:	± 10 %
Spectral range:	350 ... 1100 nm

All accuracy specifications relate to the respective measuring range end value.

---

Ref.-no.

### Fastening arm

(Spare part)

for installation of the universal weather station, ref.-no.: 2225 WSU

---

**2225 BFA**



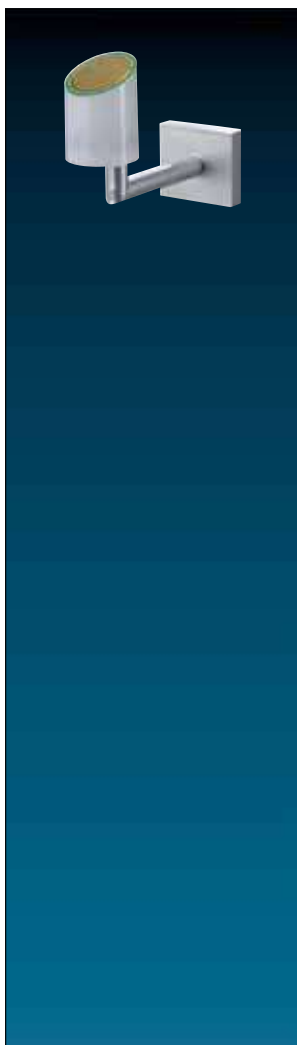

Ref.-no.

**KNX weather station "home"****2224 WH**

The KNX weather station detects the meteorological data "Wind speed", "Precipitation", "Twilight", "Temperature" and the brightness in three directions. Its main area of application is the automatic, weather-dependent control of shading. It is specially designed for use in homes. To increase functional reliability, the weather station monitors itself in some important functions, and reports any corresponding errors to the bus automatically via indicator objects. It is intended for outdoor installation on a mast or on a wall. The bus coupling to the KNX/EIB is integrated (monoblock). Evaluation of the data themselves, in particular the limiting value processing, is performed already in the weather station. A built-in heater protects against degradation of function from frost and moisture condensation down to  $-20\text{ }^{\circ}\text{C}$ . The heating system further ensures that the sensor surface of the precipitation sensor will dry off quickly after rain, and also melts snow and ice. Power is supplied to the unit via the bus, except for the heating system and the power supply for the precipitation sensor. The weather station requires an external 24 V AC/DC power supply for the heating system, without which precipitation detection is not possible. Logic gates are available for cascading a number of weather stations and for linking the limiting values and the monitoring functions. Blocking elements make it possible to block individual functions at the installation location.

**Intended use**

- Measurement and evaluation of weather data: wind speed, precipitation, twilight, temperature and brightness
- Vertical mounting on the outside of buildings, preferably on roofs and at façades

**Product characteristics**

- Integrated KNX bus coupler
- Compact housing
- Low-maintenance device
- Measured-value acquisition and limit value monitoring

**The power supply ref.-no.: WSSV 10 is necessary for precipitation detection.**

**Technical data**

Rated voltage KNX:	DC 21 ... 32 V SELV
Power consumption KNX:	typical 450 mW
Connection, KNX:	KNX bus connection block
External power supply	
Rated voltage:	AC/DC 24 V SELV
Power consumption:	typical 7.5 W
Connection:	connecting terminal yellow/white
Ambient temperature:	$-20\text{ }^{\circ}\text{C}$ ... $+55\text{ }^{\circ}\text{C}$ (free of ice and dirt)
Storing temperature:	$-40\text{ }^{\circ}\text{C}$ ... $+70\text{ }^{\circ}\text{C}$
Protection level:	IP 44 (in position for use)
Protection class:	III
Dimensions (W x H x D):	approx. 88 x 170 x 204 mm (with assembly arm)
Weight:	approx. 240 g

**Sensor signals**

Temperature sensor	
Measuring range:	$-20\text{ }^{\circ}\text{C}$ ... $+55\text{ }^{\circ}\text{C}$
Accuracy:	$\pm 1\text{ K}$ (for wind speeds $> 0.5\text{ m/s}$ )
Wind sensor	
Measuring range:	approx. 0 ... 40 m/s
Accuracy:	$\pm 2\text{ m/s}$
Precipitation sensor	
Measuring range:	precipitation yes / no
Sensitivity:	fine drizzle
Switch-off delay:	adjustable
Brightness sensor	
Direction:	east, south, west
Measuring range:	approx. 1 ... 110 klx
Spectral range:	approx. 700 ... 1050 nm
Accuracy:	10 % (upper end of measuring range)
Dawn sensor	
Direction:	south
Measuring range:	approx. 0 ... 674 lx
Spectral range:	approx. 700 ... 1050 nm
Accuracy:	10 % (upper end of measuring range)

		Ref.-no.
<b>Connection set</b>		
<b>for weather station home ref.-no.: 2224 WH</b>		
for pole mounting 50 – 120 mm Ø		<b>MM 100</b>
for edge mounting	white	<b>MW 270 WW</b>
	aluminium (lacquered)	<b>MW 270 AL</b>

**Analogue input, 4-gang**

Rail mounting device, 4 rail units

ETS product family: Input

Product type: Analogue input 4-gang

**2214 REG A**

The analogue input processes measured-value data supplied by analogue sensors.

Four analogue transducers in any combination can be connected to the input.

The analogue input evaluates voltage and current signals.

Voltage signals: 0 ... 1 V DC 0 ... 10 V DC

Current signals: 0 ... 20 mA DC 4 ... 20 mA DC

The 4 ... 20 mA current inputs can be monitored for open-circuit conditions.

**The analogue input needs a separate power supply,  
for example the power supply module ref.-no. WSSV 10.**

**Technical data**

Supply voltage:	AC 24 V ~ ± 10 %
Analogue inputs:	4
Format:	EIS 5 (2 Byte) or EIS 6 (1 Byte)
Ranges:	voltage 0 ... 1 V, 0 ... 10 V; current 0 ... 20 mA, 4 ... 20 mA; depending on parameterization
Limit values:	2 per channel
Supply output for sensor:	2 terminal pairs
Voltage:	DC 24 V ± 25 %
Total current:	max. 100 mA





Ref.-no.

**Analogue input extension module, 4-gang**

Rail mounting device, 4 rail units  
extension module for analogue input

**2214 REGAM**

The analogue input extension module provides a KNX analogue input 2214 REG A with four additional sensor inputs. The evaluation of the measured data and the limiting values will be handled by the connected KNX device.

The analogue input extension module evaluates voltage and current signals.

Voltage signals: 0 ... 1 V DC 0 ... 10 V DC

Current signals: 0 ... 20 mA DC 4 ... 20 mA DC

**Technical data**

External supply

Voltage: AC 24 V ~ ± 15 %  
Current consumption: max. 170 mA (incl. sensors)

Analogue inputs: 4

Measuring ranges per channel

Voltage: 0 ... 1 V, 0 ... 5 V, 0 ... 10 V (DC)  
Impedance approx. 18 kΩ

Current: 0 ... 20 mA, 4 ... 20 mA  
Impedance approx. 100 kΩ

A/D converter: 14 bit

Power supply for sensors: DC 24 V max. 100 mA

**Power supply AC 24 V ~**

**for universal weather station ref.-no.: 2225 WS U**

**for weather station home ref.-no.: 2224 WH**

**for analogue input ref.-no.: 2214 REG A**

**for analogue actuator ref.-no.: 2204.01 REGA**

Rail mounting device, 4 rail units

**WSSV 10****Product characteristics**

- Two internally connected 24 V outputs
- Overload and short-circuit protection via thermo switch

**Technical data**

Rated voltage: AC 230 V ~, 50/60 Hz  
Output current: max. 1 A  
Output voltage: AC 24 V ~  
Storage/transport temperature: -25 ... +70 °C  
Ambient temperature: -5 ... +40 °C  
Relative humidity: max. 93 % r. h., no condensation  
Mounting width: 72 mm (4 rail units)  
Connection: screw terminals  
single wire: 0.5 ... 4 mm<sup>2</sup>  
stranded with ferrule: 0.14 ... 2.5 mm<sup>2</sup>  
stranded without ferrule: 0.34 ... 4 mm<sup>2</sup>



Ref.-no.

**Wind sensor****WS 10 W****Intended use**

- Sensor for measuring weather data
- Sensor signals are evaluated via additional electronics, e.g. analogue input (ref.-no. 2214 REG A)
- Detection of the horizontal wind speed
- Vertical installation in outdoor areas, e.g. on walls of buildings, using the supplied mounting bracket

**Product characteristics**

- Measurement of the rotational speed of the anemometer
- Output with analogue output signal 0 ... 10 V
- Maintenance-free
- Operation without additional power supply possible
- To avoid dew and condensation, use a separate power supply (ref.-no. WSSV 10) for heating

**Technical data**

## Power supply

Rated voltage:	DC 18 ... 32 V SELV
Current consumption:	6 ... 12 mA

## Heating

Rated voltage:	AC/DC 24 V
Switch-on current:	max. 1 A

Ambient temperature: -25 ... +60 °C

Protection class: III

Protection level: IP 65 (in position for use)

## Output signal

Measuring range:	0.9 ... 40 m/s
Strain:	max. 60 m/s (for short periods)
Output voltage:	DC 0 ... 10 V
Load:	min. 1.5 kΩ

Cable type: LiYY 6 x 0.25 mm<sup>2</sup>

Cable length: approx. 3 m

can be extended up to: max. 100 m

Dimensions (Ø x H): 134 x 160 mm



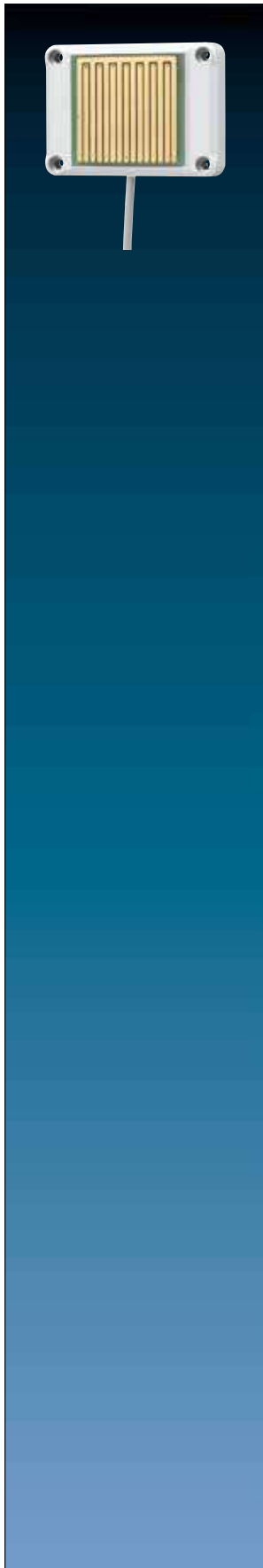

Ref.-no.

**Rain sensor****WS 10 R****Intended use**

- Sensor for measuring weather data
- Sensor signals are evaluated via additional electronics, e.g. analogue input (ref.-no. 2214 REG A)
- Detection of precipitation
- Installation in outdoor areas, e.g. on walls of buildings, using the supplied 110° mounting bracket

**Product characteristics**

- Measurement of the electrical conductivity on the sensor surface
- Output by means of analogue output signal: 0 = dry, 10 V = rain
- Heating of the sensor surface with separate 24 V AC/DC power supply, ref.-no.: WSSV 10

**Technical data**

## Power supply

Rated voltage:	DC 15 ... 30 V
Current consumption:	approx. 10 mA

## Heating

Rated voltage:	AC/DC 24 V
Power consumption:	max. 4.5 W

## Ambient temperature:

-30 ... +70 °C

## Protection class:

III

## Protection level:

IP 65

## Output signal

Output voltage: DC 0 / 10 V

Load: min. 1 kΩ

Reaction time: max. 4 min

## Cable type:

LiYY 5 x 0.25 mm<sup>2</sup>

## Cable length:

approx. 3 m

## can be extended up to:

max. 100 m

## Dimensions (Ø x H):

58 x 83 x 17 mm

	Ref.-no.
<b>Brightness sensor</b> Rated voltage 24 V DC range 0 ... 60 000 lux, linear 58 x 35 x 64 mm	<b>WS 10 H</b>

<b>Dawn sensor</b> Rated voltage 24 V DC range 0 ... 255 lux, linear 58 x 35 x 64 mm	<b>WS 10 D</b>
---	----------------

<b>Temperature sensor</b> Rated voltage 24 V DC range -30 °C ... +70 °C, linear 58 x 35 x 64 mm	<b>WS 10 T</b>
--	----------------

The brightness sensor is used for the measuring and evaluation of the brightness.

The dawn sensor is used for the measuring and evaluation of the brightness (dawn/dusk).

The temperature sensor is used for the measuring and evaluation of the temperature.

The value measured by the sensor is transmitted to an analogue output signal of 0 ... 10 V by the electronics.

#### Connections:

Plastic housing with PG7 thread + screw and pressure / moisture compensation (recommended cable 3 x 0.25 mm<sup>2</sup>)

+UB: operating voltage 24 V DC

GND: corresponding ground

OUT: output 0 ... 10 V

#### Technical data

Supply voltage:	24 V DC (15 ... 30 V DC)
Connection:	screw terminals
Terminals for:	2.5 mm <sup>2</sup>
Connecting cable:	through screwed conduit entry PG 7
Recommended cable:	3 x 0,25 mm <sup>2</sup>
Cable length:	max. 100 m
Output:	0 ... 10 V DC (into a load of at least 1 kΩ, short-circuit protected)
Ambient temperature:	-30 ... +70 °C
Protection level:	IP 65
Mounting position:	optional



# Signalling System

The KNX signalling system uses a well thought out design for optimal functionality. The core is the central centre where the display is controlled and all processes are regulated.



KNX SMART PANEL 5.1

## THE SYSTEM ALSO CONSISTS OF THE FOLLOWING MODULES AND FUNCTIONS:

### Alert

Various devices for the loud and silent alarms.

### Certainty

There is a locking unit for use on the entrance door.

### Activation

Activation is done using a key switch.

### Detectors

Sensors, contacts and movement detectors perform the monitoring tasks in rooms, on windows and doors.



**ALARM SIGNALLING**

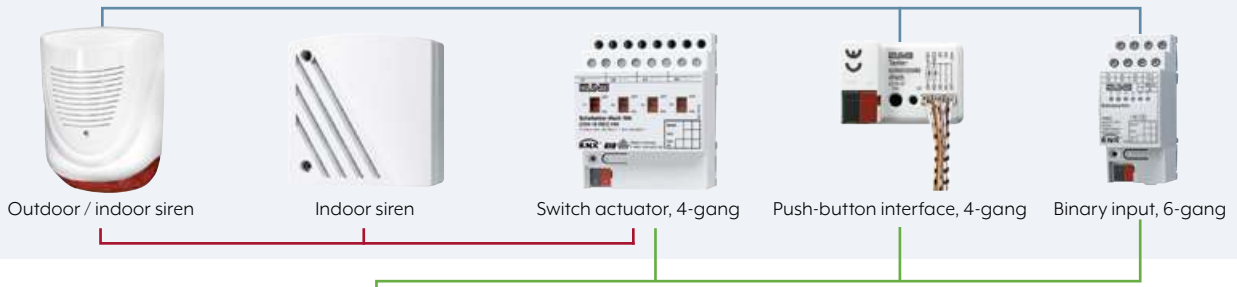

**CONTROL CENTRE**



Smart Panel 5.1

**POWER SUPPLY**



Uninterruptible Power Supply

**ACTIVATION**

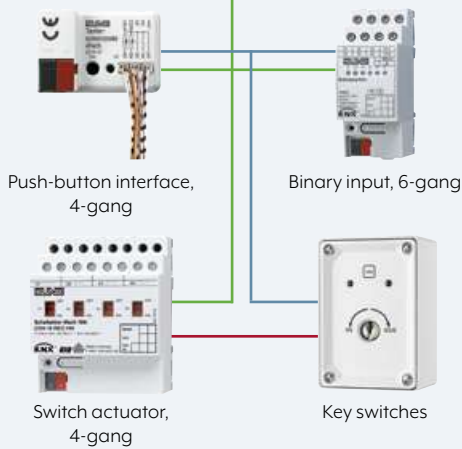

**CERTAINTY**

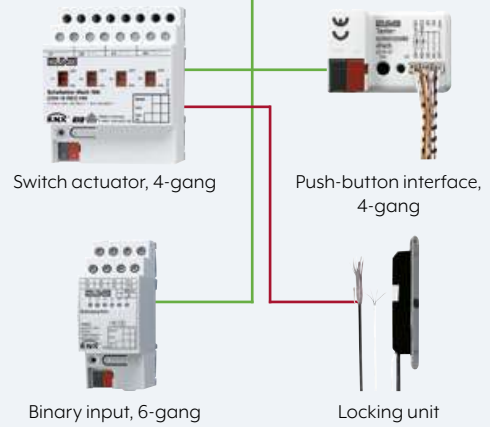

**DETECTORS**

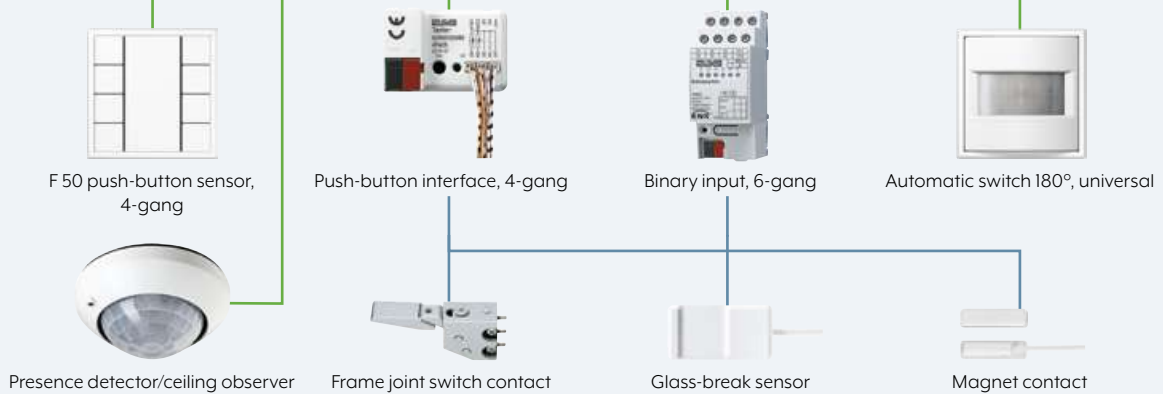



Ref.-no.

**Smart Panel  
with integrated BCU  
aspect ratio 4:3**

for installation in walls, touch screen  
fanless, without rotating parts

SP 5.1 KNX

**Intended use**

- Operation and visualisation of system statuses and information on building automation
- Flush-mounted fitting indoors

**Integrated signalling system**

A signalling system offers a safety-oriented system for the observation of windows and doors. The signalling system can display the status of window contacts, motion detectors or glass break sensors and monitors changes in the statuses of these detectors. The detectors integrated in the signalling system can be combined into up to two security areas (internal/external). Arming these areas allows monitoring of the secured area for break-ins when people are present or absent. In addition, sections of the area can be monitored for sabotage. If there is a break-in alarm, visual and acoustic alarms (flash light, siren) can be activated via KNX components (e.g. switching actuators).

Max. 40 detectors (KNX)

Two security areas

**Product characteristics**

- Illuminated graphic colour screen TFT, 640 x 480 pixels, 262 000 colours
- Touchscreen
- KNX Interface
- Interfaces – accessible from front: 1 x USB 2.0
- Interfaces – accessible from behind: Ethernet
- Graphical user interface for visualisation and operation of KNX devices
- Predefined graphical user interface
- Free graphical user interface
- KNX special functions, e.g. scenes, forced position, timer, presence simulation
- Fast access to pages and functions
- Remote access (remote function)
- Acoustic signal encoder, configurable
- Combination of predefined and free graphical user interface
- Master pages: max. 10
- Free pages: max. 50
- Elements: max. 400
- Copy & Paste functions
- 50 rooms
- 10 function units
- 240 functions, e.g.:
  - Scene recalls: max. 40
  - Signalling system: max. 40 detectors (internal and external skin together)
  - Datalogger: max. 20 datalogger channels
  - Logic gates: max. 80 gates with up to 8 inputs and one output each
  - Timers: max. 40
  - Limiting value modules: max. 40
  - Demultiplexer "1 to 2" and "1 to 4": max. of 7 each
  - Timer: max. 64 switching channels with a total of 128 switching times
  - Scenes: max. of 24 scenes, max. of 32 scene functions
  - Presence simulation: max. 8 simulations, max. 32 functions (15 functions per simulation)
  - Fault messages: max. 50
  - Event e-mails: max. 50
  - Video messages: max. 8
  - System time: max. 40

Frames and accessories see page 241

	Ref.-no.
<b>Indoor siren</b>	
	<b>DAS 4120</b>
To be integrated into the signalling system of the Smart Panels by the KNX system via switching actuators (flash light and siren). Supply voltage 12 V DC, separate power supply	
<b>Key switch/push-button</b> for activating and deactivating of alarm systems	
Surface-mounted	<b>DAS 4300 A</b>
Housing, front plate: diecast aluminium Dimensions of housing (W x H x D): 79 x 113 x 54 mm Colour: white RAL 9010	
<b>Key switch/push-button</b> for activating and deactivating of alarm systems	
Flush-mounted	<b>DAS 4300 U</b>
Housing, front plate: aluminium (precision casting) Dimensions of front plate (W x H x D): 101 x 135 x 3 mm Dimensions of flush housing (W x H x D): 79 x 113 x 54 mm profile cylinder lock is not included • wired • sealed housing for indoor and outdoor use • either permanent or pulse contact • two LED for individual wiring • buzzer for acknowledgement or refusal • tear-off and lift-off contact against sabotage • protection against drilling To be integrated into the signalling system of the Smart Panels by the KNX system via binary inputs / push-button interfaces (evaluation armed/unarmed) and switching actuator (ACK buzzer / LED). Cable: min. 6 wires Supply voltage 12 V DC, separate power supply	
<b>Technical data</b>	
Operating voltage:	9 ... 15 V DC
Rated voltage:	12 V DC
Current consumption per LED:	approx. 10 mA
Current consumption buzzer:	approx. 25 mA
Buzzer:	buzzer 12 V 85 dBA / 10 cm
Permissible load of all contacts:	max. 60 V / 0.5 A
Protection level:	IP 54
<b>Locking cylinder for key switches</b> with 3 keys	
different locks	<b>28</b>
equal locks	<b>28 G1</b>
<b>Key</b> <b>for locking cylinder 28 G1</b> (Spare part)	
1 piece	<b>28 G1 SL</b>

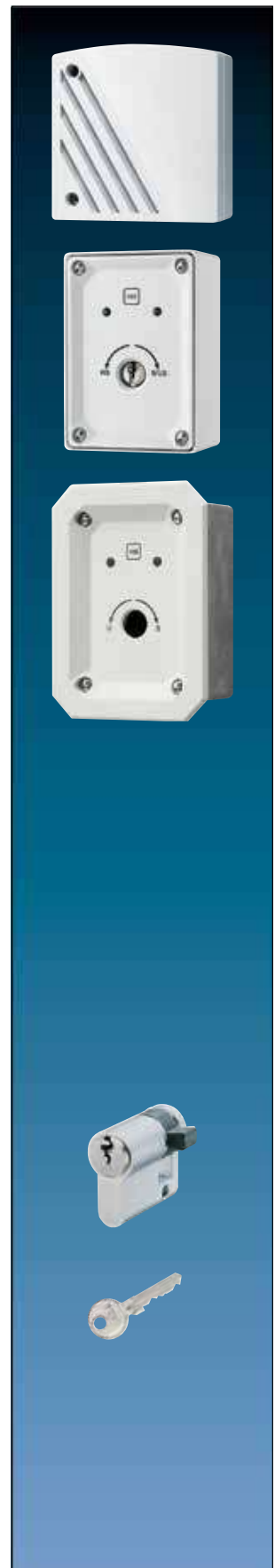





Ref.-no.

**Locking unit****DAS 4370**

The motorized locking unit serves for the mechanical door lock.

It prevents an unintended entering of armed security areas.

Can be cascaded for several doors.

Features:

- Robust housing of plastics and stainless steel
- Electrical and mechanical emergency operation
- Low noise
- Low stand-by current
- Integrated magnetic contact
- Acknowledge of the bolt position
- To be controlled with static or dynamic signals
- Simple adaption to the door frame

One magnet and two counterparts are included in the delivery. To be integrated into the signalling system of the Smart Panels by the KNX system via switching actuators (inputs and emergency opening) or via binary inputs / push-button interfaces (evaluation of the locking unit outputs and the integrated magnetic contacts) respectively.

Supply voltage 12 V DC, separate power supply

**Movement detector**

PIR detection

**DAS 4210**

Detected area: 90° (volumetric), 34 double zones in 3 levels, maximum detected area approx. 15 x 15 m

The detector is a compact passive infra-red movement detector with micro processor. It is designed to be highly reliable and versatile. The detector has a memory which can be called by a signal at the control input. If the alarm system is active, a movement detection will trigger a relay and activate the memory logic.

The test LED is automatically disabled in the active state – there is no optical indication.

If the alarm system is deactivated (no signal at set input) a stored alarm will be indicated by a permanently lit LED. The stored alarm will automatically be deleted when the alarm system is activated again.

Since the control signal for the set input may vary, depending on the central unit, the polarity of the signal can be changed at the PIR detector.

The pyroelectric element of the PIR detector is separately encased to prevent insects or atmospheric turbulence to trigger false alarms.

The detector can be mounted at a wall or in a room corner.

To be integrated into the signalling system of the Smart Panels by the KNX system via binary inputs / push-button interfaces (evaluation of movement or sabotage).

Supply voltage 12 V DC, separate power supply

		Ref.-no.
<b>Frame joint switch contact</b>		
		<b>DAS 4360</b>
<p>Electromechanical switching contact for monitoring the locking of doors.                      To be mounted into the locking plate of the door frame and is activated by closing the door.                      Micro switch, dust and water proof with solder connection                      Zn diecast housing                      no limitation of the bolt path                      Construction kit with extension piece                      To be integrated into the signalling system of the Smart Panels by the KNX system                      via binary inputs / push-button interfaces.</p>		
<b>Glass-break sensor, passive</b>		
white	similar RAL 9010	<b>FUS 4415 WW</b>
<p>break contact                      for monitoring of plane glass surfaces (no laminated, structured or wired glass)                      A glass break or damage causes typical ultrasonic signals. The frequency and amplitude is evaluated.                      The generated energy activates the alarm by piezo ceramic vibrations.                      opening of the signalling line for approx. 0.5 to 5 seconds, depending on the glass type.                      To be integrated into the signalling system of the Smart Panels by the KNX system                      via binary inputs / push-button interfaces.</p>		
<b>Magnet contact</b>		
white	similar RAL 9010	<b>FUS 4410 WW</b>
brown		<b>FUS 4410 BR</b>
<p>A sealed tubular glass envelope protects the magnet contact (reed contact) against dust and water.                      The reed contact is actuated by means of a permanent magnet.                      For installation in steel profiles (magnetic material) only block reed contacts can be used.                      Included in delivery:                      2 surface-mounted housings, 2 caps,                      3 spacers 2 mm                      1 spacer 6 mm                      To be integrated into the signalling system of the Smart Panels by the KNX system                      via binary inputs / push-button interfaces.</p>		

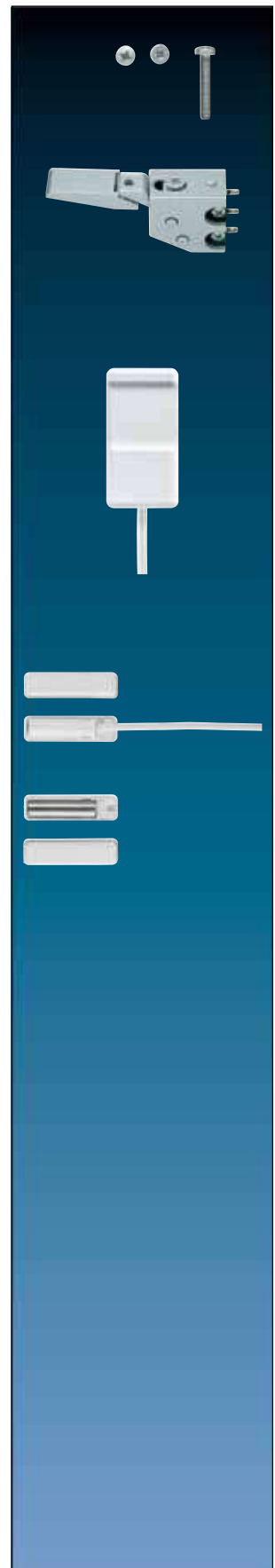

# Signal panel



## KNX SIGNAL PANEL

Surface mounting variant with robust plastic enclosure

The KNX signal panel is ideal for use in supermarkets, shops and offices. There are 24 capacitive sensor buttons on its high quality glass front that are used to control the lighting, blinds and scene functions for the entire premises. 24 coloured RGB LEDs and individual labelling strips make labelling simple and clear.

	Ref.-no.
<b>Signal panel</b>	
ETS product family: Display	
Product type: Signal panel	
glass green	<b>MBT 2424</b>
glass white	<b>MBT 2424 WW</b>
glass black	<b>MBT 2424 SW</b>
<p>The glass panel with aluminium housing is equipped with 24 capacitive sensor buttons and 24 status LEDs. The panel enables the control of switching, dimming and push-button functions as well as light scene and value transmitter functions. The LEDs can be separately parameterised to be illuminated in green, red or blue to signalise different situations of the KNX installation. Single sensor buttons, full columns or the entire panel can be blocked with blocking functions. Acoustic signals when pushing the sensor buttons can be parameterised. The surface can be labelled with exchangeable labelling foils, which can be labelled with the JUNG label tool.</p> <p>The MBT 2424 will be installed into a 2-gang wall box or a surface-mounted housing.</p> <p>Programming takes place via ETS.</p> <p>A drilling template and a bit for assembling will be delivered with the device.</p>	
<b>Product characteristics</b>	
<ul style="list-style-type: none"> <li>• Switching, dimming, push-button and blinds control, value transmitter and light scenes</li> <li>• High quality glass surface with 24 sensor buttons</li> <li>• Operation via touching the sensor buttons</li> <li>• Labelling with exchangeable labelling foil</li> <li>• Status feedback with 24 LEDs; the colours red, green and blue can be configured</li> <li>• Acoustical feedback for touching sensor</li> <li>• Fault message on dismantling</li> <li>• Logic and time functions</li> <li>• Integrated BCU</li> <li>• Supply via separate power supply (ref.-no. NT 2405 VDC) or the auxiliary voltage output of the KNX power supply</li> </ul>	
<b>Surface-mounted housing</b>	
for signal panel ref.-no.: MBT 2424 ..	
	<b>EBG 2424</b>
<b>Flush-mounted power supply</b>	
for signal panel ref.-no.: MBT 2424 ..	
	<b>NT 2405 VDC</b>





# Smart Panel



KNX SMART PANEL 5.1



Operating comfort on 14.5 cm screen diagonal: Thanks to integrated control software, the functions are displayed and controlled using the colour TFT touchscreen with the KNX Smart Panel 5.1.

### JUNG GRAPHICAL USER INTERFACE

Visualisation and operation are performed using the uniform JUNG user interface that allows logical and intuitive operation of the various functions. This is generated quickly using the Smart Panel Designer.



### FREELY CONFIGURABLE USER INTERFACE

As an alternative or additionally, a freely configurable user interface can be created. This enables the realisation of an individual display for the user.



Additional security is provided by the integrated signalling system in the Smart Panel for up to 40 detectors for interior and exterior perimeter protection. Additional functions are the 64-channel week timer with random and astro functions, the pre-configured lighting scene management, data logger for consumption data, limit value modules, and logic and time gates. These optimise the features and are quickly integrated.



Ref.-no.

**Smart Panel  
with integrated BCU  
aspect ratio 4:3**

for installation in walls, touch screen  
fanless, without rotating parts

**SP 5.1 KNX****Intended use**

- Operation and visualisation of system statuses and information on building automation
- Flush-mounted fitting indoors

**Product characteristics**

- Illuminated graphic colour screen TFT, 640 x 480 pixels, 262 000 colours
- Touchscreen
- KNX Interface
- Interfaces – accessible from front: 1 x USB 2.0
- Interfaces – accessible from behind: Ethernet
- Graphical user interface for visualisation and operation of KNX devices
- Predefined graphical user interface
- Free graphical user interface
- KNX special functions, e.g. scenes, forced position, timer, presence simulation
- Fast access to pages and functions
- Remote access (remote function)
- Acoustic signal encoder, configurable
- Combination of predefined and free graphical user interface
- Master pages: max. 10
- Free pages: max. 50
- Elements: max. 400
- Copy & Paste functions
- 50 rooms
- 10 function units
- 240 functions, e.g.:
  - Scene recalls: max. 40
  - Signalling system: max. 40 detectors (internal and external skin together)
  - Datalogger: max. 20 datalogger channels
  - Logic gates: max. 80 gates with up to 8 inputs and one output each
  - Timers: max. 40
  - Limiting value modules: max. 40
  - Demultiplexer "1 to 2" and "1 to 4": max. of 7 each
  - Timer: max. 64 switching channels with a total of 128 switching times
  - Scenes: max. of 24 scenes, max. of 32 scene functions
  - Presence simulation: max. 8 simulations, max. 32 functions (15 functions per simulation)
  - Fault messages: max. 50
  - Event e-mails: max. 50
  - Video messages: max. 8
  - System time: max. 40



	Ref.-no.
<b>Frame for Smart Panel ref.-no.: SP 5.1 KNX</b>	
aluminium	<b>FP AL 781</b>
stainless steel	<b>FP ES 781</b>
Dimension: 236 x 170 x 10 mm (W x H x D)	
<b>Glass frame for Smart Panel ref.-no.: SP 5.1 KNX</b>	
glass green	<b>FP GLAS 781</b>
glass white	<b>FP GLAS 781 WW</b>
glass black	<b>FP GLAS 781 SW</b>
Dimension: 236 x 170 x 10 mm (W x H x D) safety glass acc. DIN 1249	
<b>Frame for Smart Panel ref.-no.: SP 5.1 KNX</b>	
aluminium	<b>R 5 AL E</b>
white (aluminium lacquered)	<b>R 5 WW E</b>
Dimension: 232 x 152 x 7 mm (W x H x D)	
<b>Frame for Smart Panel ref.-no.: SP 5.1 KNX industrial version</b>	
anthracite	<b>FPI 781 AN</b>
Dimension: 236 x 170 x 6 mm (W x H x D)	
<b>Flush-mounted recessed box for Smart Panel ref.-no.: SP 5.1 KNX</b>	
cut-out dimensions (W x H): 212 x 124 mm installation depth: 75 mm	
	<b>EBG 24</b>
can also be used for hollow wall mounting	



# Smart Controls



SMART CONTROL 15



Multifunctional control panel for smart buildings: The smart controls take over the control of various systems for building automation using apps. Thanks to the JUNG Launcher, all available applications are clearly displayed and can be called up directly by tapping on the respective icon. Due to the open operating system, the smart controls can be extended by other apps at any time. They are available in four different versions, depending on the application. In the most compact variant with a screen diagonal of seven inches, the Smart Control can also be mounted vertically.

#### VARIANTS

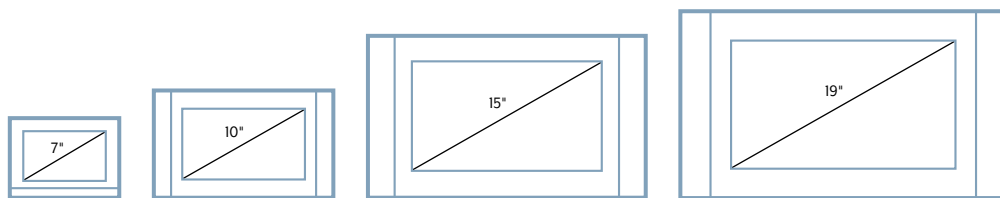

The Smart Controls for wall mounting are available in four sizes as required.

# Server and Launcher

## SMART VISU SERVER



For a standard KNX installation in private construction

## VISU PRO SERVER



For complex KNX installations in commercial or private properties

## SIEDLE SMART GATEWAY



For connection to the door communication

## eNet SERVER



For integration in the eNet SMART HOME

With the Smart Controls, KNX and eNet SMART HOME installations and door intercom functions can be operated using only one device, also in parallel. In combination with various system servers, all settings and functions are then conveniently controlled using the apps via Launcher. Thereby, options for use in private as well as commercial construction can be selected.

## KNX

KNX functions and scenes displayed on the JUNG Launcher and individually matched to the requirements.



## DOOR COMMUNICATION

The Smart Controls become video intercom stations using the link with the Siedle Smart Gateway.

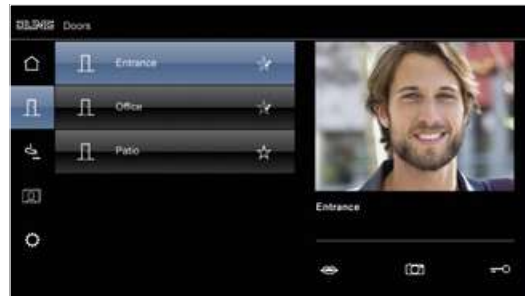

## WEATHER SCREEN

Good outlooks: The preinstalled screen shows local weather and travelling weather for the next few days.

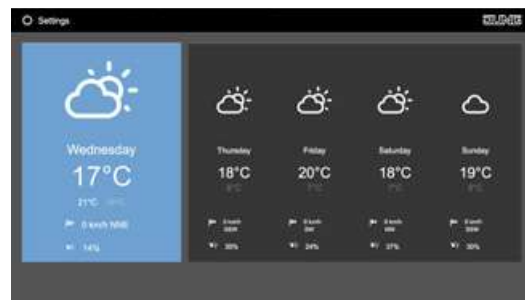

## WASTE SCHEDULER

Waste disposal dates can be registered individually; the reminder is performed automatically.



## eNet SMART HOME

Visualise the wirelessly networked smart home and control via the user interface of the Smart Controls.

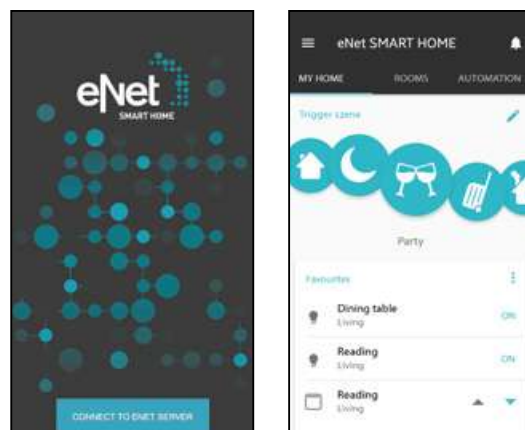



Ref.-no.

**Smart Control 7"****aspect ratio 16:9**

for installation in walls, capacitive touch screen

fanless, without rotating parts

aluminium

**SC 7 AL**

black

**SC 7 SW**

- Door call function only in combination with Siedle Smart Gateway SG 650-..
- Smart Gateway with integrated image storage
- For vertical or horizontal installation

Further functions:

- KNX visualisation in combination with Visu Pro Server (ref.-no.: JVP-SERVER-H)
- KNX visualization in combination with Smart Visu Server (ref.-no.: SV-SERVER-INT)
- Pre-installed iHaus-Server-App; iHaus-KNX connection exclusively via IP router (ref.-no.: IPR 200 REG) or IP interface (ref.-no.: IPS 200 REG)
- eNet visualisation in combination with eNet server for rail mounting (ref.-no.: ENET-SERVER) up to software version 1.4
- eNet visualisation in combination with eNet radio IP gateway IP (ref.-no.: FM-GATE-IP)
- Pre-installed weather page

**Update firmware prior to commissioning.****Please check Release Notes.****Flush-mounted recessed box**

for Smart Control ref.-no.: SC 7 AL, SC 7 SW

cut-out dimensions (W x H): 202 x 141 mm

installation depth: 67 mm

**SC 7 EBG****Power supply for rail mounting**

for Smart Control ref.-no.: SC 7 AL, SC 7 SW, SC 10, SC 15, SC 19

Rail mounting device, 4 rail units

**NT 2415 REG VDC**

	Ref.-no.
<p><b>Smart Controls</b></p> <ul style="list-style-type: none"> <li>• Door call function only in combination with Siedle Smart Gateway SG 650-..</li> <li>• KNX visualisation in combination with Visu Pro Server (ref.-no.: JVP-SERVER-H)</li> <li>• KNX visualization in combination with Smart Visu Server (ref.-no.: SV-SERVER-INT)</li> <li>• Pre-installed iHaus-Server-App; iHaus-KNX connection exclusively via IP router (ref.-no.: IPR 200 REG) or IP interface (ref.-no.: IPS 200 REG)</li> <li>• eNet visualisation in combination with eNet server for rail mounting (ref.-no.: ENET-SERVER) up to software version 1.4</li> <li>• eNet visualisation in combination with eNet radio IP gateway IP (ref.-no.: FM-GATE-IP)</li> <li>• Pre-installed weather page</li> </ul> <p><b>Update firmware prior to commissioning.</b>  <b>Please check Release Notes.</b></p>	
<p><b>Smart Control 10.1"</b>  <b>aspect ratio 16:9</b>  for installation in walls, capacitive touch screen  fanless, without rotating parts  25.6 cm – 10.1"</p>	<b>SC 10</b>
<p><b>Flush-mounted recessed box</b>  for Smart Control ref.-no.: SC 10  cut-out dimensions (W x H): 315 x 182 mm  installation depth: 80 mm</p>	<b>SC 10 EBG</b>
<p><b>Smart Control 15.6"</b>  <b>aspect ratio 16:9</b>  for installation in walls, capacitive touch screen  fanless, without rotating parts  39.6 cm – 15.6"</p>	<b>SC 15</b>
<p><b>Flush-mounted recessed box</b>  for Smart Control ref.-no.: SC 15  cut-out dimensions (W x H): 492 x 288 mm  installation depth: 80 mm</p>	<b>SC 15 EBG</b>
<p><b>Smart Control 18.5"</b>  <b>aspect ratio 16:9</b>  for installation in walls, capacitive touch screen  fanless, without rotating parts  47 cm – 18.5"</p>	<b>SC 19</b>
<p><b>Flush-mounted recessed box</b>  for Smart Control ref.-no.: SC 19  cut-out dimensions (W x H): 582 x 327 mm  installation depth: 80 mm</p>	<b>SC 19 EBG</b>





# Smart Visu Server





Lighting mood, comfortable temperature, sun protection, music: intelligently networked, brilliantly displayed. One fingertip and the comfort scene is set. Everything controlled with a smartphone. That is how easily a home becomes a Smart Home with the Smart Visu Server.

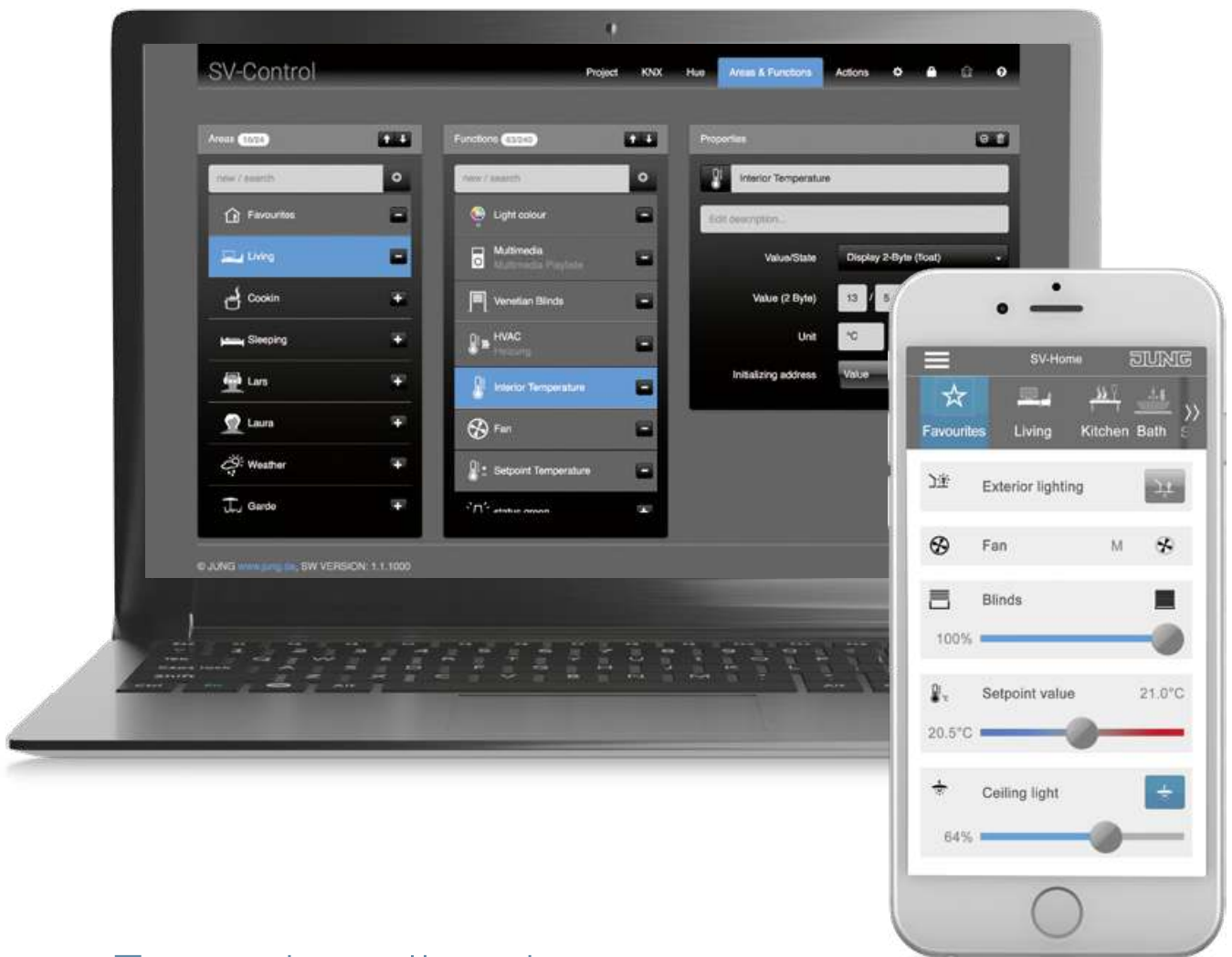

## Fast visualisation

The Smart Visu Server is integrated into the home network via the router. It is simply networked with the Smart Home using an IP connection. With the integrated start-up interface SV Control, the visualisation for the KNX installation is then built up step by step. SV Control works independently of the operating system and leads the user intuitively through the sequence for setting up.

### AWARD-WINNING

The Smart Visu Server with its clear, intelligent visualisation also impressed the respected expert jury of the German Design Award, the prestigious prize of the German Design Council.



## PASSWORD PROTECTION

The areas that the end customer may edit himself are defined during the project handover. All others are password-protected. The password must be advised if the end customer would like to edit additional areas. This can also represent a clear handover point of the responsibility and warranty obligation.



## ALWAYS UP-TO-DATE

All automatic updates and upgrades for the Smart Visu Server are listed chronologically in the "Change Log" document. This is available to download as a PDF at [www.jung.de/svs](http://www.jung.de/svs).



## ETS IMPORT

An existing KNX installation is imported directly from the ETS using an OPC file. The group addresses are presented in a sortable list for an optimum overview and simple allocation.

Group address	Group name	Description	Length	Import date
001	Central Escalator	Escalator control	1 Byte	2022/01/14 4:20:08 PM GMT+1
010	Central Decoupling	Schalter	1 Bit	2022/01/14 4:20:08 PM GMT+1
015	Central Decoupling	Schalter FM	1 Bit	2022/01/14 4:20:08 PM GMT+1
016	Zentrale Jalousie	Zentrale Jalousie	1 Bit	2022/01/14 4:20:08 PM GMT+1
100	Relaiswandler Schalter	Dezinter-Relaiswandler (Relaiswandler)	1 Bit	2022/01/14 4:20:08 PM GMT+1
101	Relaiswandler Schalter	Leuchte Schalter (Relaiswandler)	1 Bit	2022/01/14 4:20:08 PM GMT+1
102	Relaiswandler Schalter	Leuchte Schalter (Relaiswandler)	1 Bit	2022/01/14 4:20:08 PM GMT+1
110	Relaiswandler Schalter FM	Dezinter-Relaiswandler FM (Relaiswandler)	1 Bit	2022/01/14 4:20:08 PM GMT+1
111	Relaiswandler Schalter FM	Leuchte Schalter FM (Relaiswandler)	1 Bit	2022/01/14 4:20:08 PM GMT+1

## AREAS AND FUNCTIONS

Afterwards, areas are created first, such as rooms or trades. Functions are allocated to these areas. Both are named individually and provided with symbols. In this way, 240 functions with up to 1,200 data points can be created.



## BLOCK FUNCTIONS

The new Heating, Ventilation, Climate function groups as well as Multimedia Playlist and Multimedia Mode as „block functions“ are both easier to integrate as well as to use.



Structure creates the overview and convenience: with their own, individual groups, individual actions can be combined suitably so that the user can then call them and activate them as required.

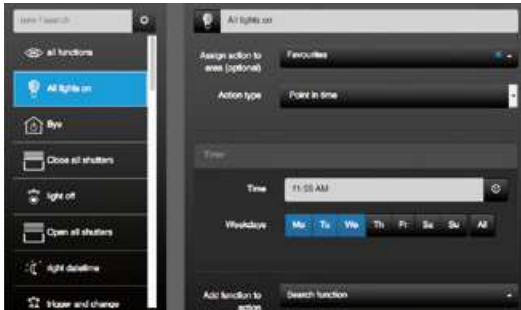

### CREATE ACTIONS

To create an action, first of all it is named. Allocating meaningful names under which functions will be collected is helpful. If required, the action can then be allocated to an area, such as a particular room or trade.



### ADD FUNCTIONS

Up to 16 functions can be allocated to an action and displayed in a selection list. The appropriate value is set for every function, such as "Colour light on" or "Dining table lamp on 50 %". In addition, time controls for actions can be specified.

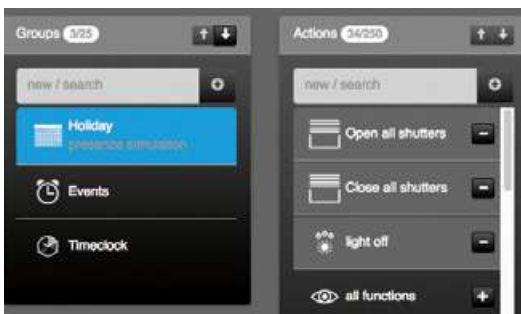

### CREATE GROUPS

Groups can then be assembled and named from the actions. For example, "Holiday" includes all actions for presence simulation, such as "Open all shutters", "Living room lamps 100 %" and "Path lighting on". Each action can be allocated to multiple groups.



### USE GROUPS

Using the appropriate button on the Smart Visu Home user interface, the user can call individual groups. If the user wants to activate/deactivate or edit a group, this takes place in SV Control. The installer defines the rights via the password protection.

Feel-good lighting with the Smart Visu Server: With the connection to the Philips Hue lighting system, users can create their own personal light scene with a tap of a finger on their smartphone.

#### AUTOMATIC SCAN

As soon as a Hue Bridge with learnt devices/lights is recognised in the network, it can be accessed on the Smart Visu Server interface.

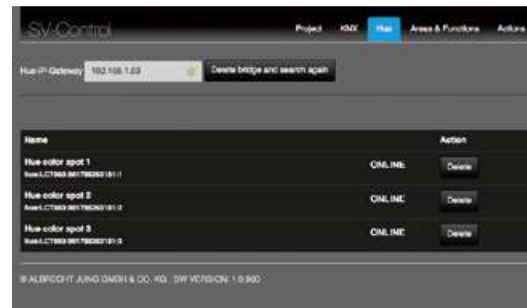

#### NAME/ALLOCATE LUMINAIRES

After the taught-in luminaires have been detected, individually appropriate names can be assigned. The lights named can then be appropriately allocated to individual areas and a room, favourite or trade.



#### CONVENIENT CONTROL

Control of the integrated lights is then via the Smart Visu Home user interface, as desired with a slider.







## Smart Visu Home

The Smart Visu Home user interface is realised in Responsive Design. This guarantees optimal presentation and operation on almost every smart device. Landing pages, background colour, font size and other content can also be individually adapted for each device and thus for each user. Responsive Design also takes account of the use of the smart devices in portrait or landscape orientation.



Ref.-no.

**Smart Visu Server**

with mounting plate for wall or rail mounting installation  
including plug-in power supply  
with Europlug

**SV-SERVER****Intended use**

- Visualisation and operation of KNX systems via devices with HTML5 browser, e.g. Smart Control (ref.-no.: SC 7 ..., SC 10, SC 15, SC 19), smartphone, tablet, laptop, PC, etc.
- Visualisation and operation of Philips Hue systems
- Operation in local IP networks, which support DHCP (Dynamic Host Configuration Protocol) or with a fixed IP address (IPv4)
- Operation indoors

**Product characteristics**

- Web visualisation of KNX system for status indication and operation (SV-Home)
- Integrated web-based commissioning tool (SV-Control)
- Easy to create a pre-configured user interface, optimised for domestic applications and small commercial facilities
- Graphical control elements: symbols can be selected from supplied libraries
- Import of group addresses (three-stage) via OPC import (ETS3, ETS4, ETS5)
- Manual input of group addresses possible
- 24 areas
- 240 dynamic functions (max. 1200 data points)
- 250 configurable actions (max. 16 functions per action)
  - customised
  - switching times
  - status logic
  - depending on events
- Connection to KNX bus via KNX IP router (ref.-no. IPR 200 REG) or KNX IP interface (ref.-no. IPS 200 REG)
- Integration of Philips Hue systems in the KNX installation
- Connection to Philips Hue via Philips Hue Bridge
- Update and upgrade compatible





## JUNG Visu Pro

This software, as successor of Facility Pilot, is the professional way to visualise and control building automation. Multiple, independent KNX systems can be included and managed conveniently at the same time.



### **VISUALISATION**

The visualisation can be individually customised.



### **GENERATOR**

Imports projects created with the Smart Assistant.

**COMMERCIAL USE**

Visualisation and control using an HTML5-capable browser

**PRIVATE USE**

Can be optimally tailored to the respective application situation

The JUNG Visu Pro software is a flexible system without data point limits and is thus also perfectly suited to complex applications, whether in the private or trade field. Particularly the option to include multiple independent KNX systems parallel in one process model via

KNXnet/IP protocol creates comprehensive possibilities for property-spanning projects. The Visu Pro software can be displayed on all HTML5-capable browsers, naturally including mobile end devices.

**DEVICE EDITOR**

Integration of different systems in the visualisation.

**PROCESS EDITOR**

Configuration of process models with KNX and OPC data.

The Visu Pro software consists of various function modules, each of which clearly deals with a task. The modules/editors familiar from the Facility-Pilot for creating the visualisation have been optimised and simplified with respect to their use and graphical representation.



### VISUALISATION

HTML5 visualisations are created consistently, thus guaranteeing the representation on different types of device. For this purpose, the control library has been significantly extended with HTML5 elements. The HTML5 controls can be freely placed on the spreadsheets and the look of the operating elements can be completely individualised.

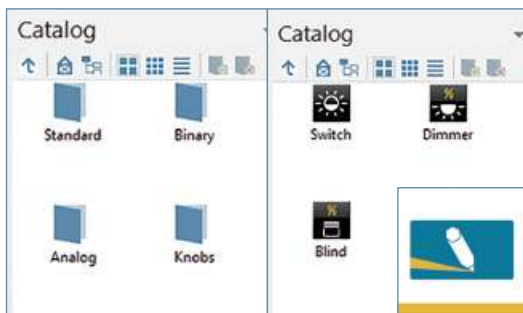

### CONTROL LIBRARY

The JUNG symbol set is supplied as a library in black and white. Alongside form factor, transparency and background image can be set, as well as separate views. In addition, individual symbols can also be imported and used appropriately.



### PROCESS MODEL

The process model is the logical core of the system. Process connections are integrated here, logics, time functions and scenes defined and charts produced.

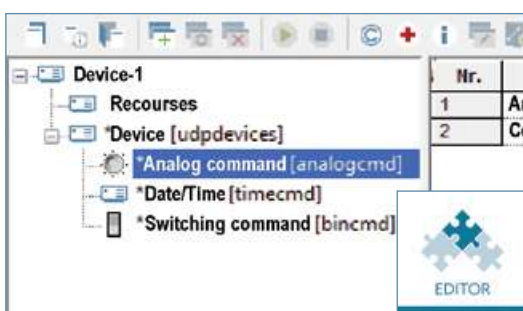

### DEVICE EDITOR

Special functions can be implemented here with process interfaces. System integrators with knowledge of LUA can independently program functions, including the communication with third party systems via TCP or UDP protocol (e.g. devices from consumer electronics).

Smart Assistant – intuitive planning assistance: To create JUNG interfaces, the system integrator can fall back on the Smart Assistant for automatic generation and thus minimise the creation effort. Visualisations can thus be prepared based on templates supplied.



## CONFIGURATION

First of all, functions, timer switches and scenes are selected from a tabular list and added to the individual project. These can be linked with each other as appropriate if required.

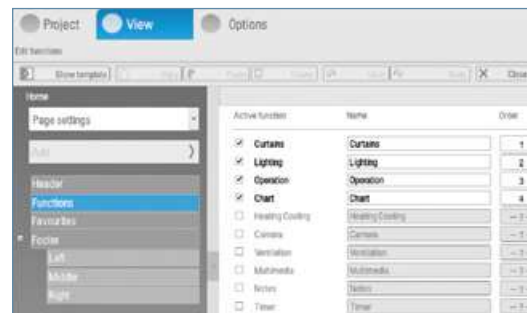

## EXAMPLE: SMART METERING

With the production of a consumption data chart, the settings for recording various consumptions are made, such as for electricity, water and gas. The visualisation of the consumption data check is then automatically generated from this.

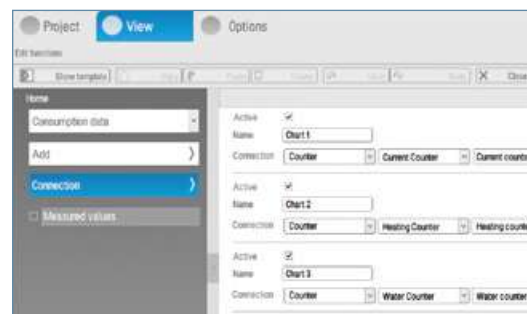

## CREATE BUILDING STRUCTURE

Afterwards, the building structure can be produced based on the floors and rooms, in each case with individual names. The previously configured functions and scenes can be allocated as appropriate and thus transferred to the visualisation.

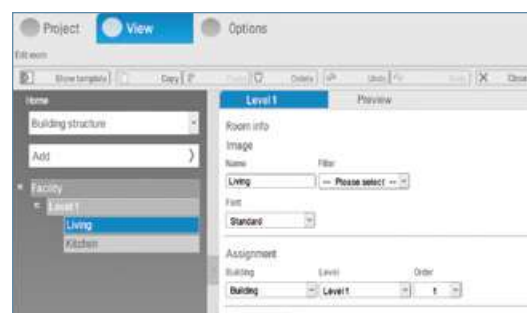

# Visu Pro Server

The JUNG Visu Pro Server is a device for controlling building automation in conjunction with the pre-installed Visu Pro software. With its compact dimensions of 12 x 12 x 2.4 cm, the server is designed for installation on a wall rail or DIN rail. The maximum project scope is based on the templates as created using the JUNG Smart Assistant and is thus ideally suitable for applications in demanding private constructions.

## NUMEROUS INTERFACES TO OTHER SYSTEMS



SD card slot

2 x USB 2.0



USB 3.0

HDMI™ connection

Gigabit-LAN

3.5 mm audio jack

Ref.-no.

**Visu Pro Server**

fanless, without rotating parts

English version

**JVP-SERVER-H-GB****Intended use**

- Visualization and operation of system statuses and information on building automation in combination with JUNG Visu Pro software (pre-installed)
- Desktop device, mounting on DIN rail according to EN 60715 possible
- Max. size of the visualization project as template in JUNG Smart Assistant
- Connection to KNX bus via KNX IP router (ref.-no. IPR 200 REG) or KNX IP interface (ref.-no. IPS 200 REG)

**Product characteristics**

- Fanless mini PC
- JUNG Visu Pro software pre-installed and activated
- KNX interface (e.g. IPS 200 REG) needs to be ordered separately
- Windows 10 Home (64-bit) pre-installed
- Quadcore Intel Atom processor
- 2 GB RAM
- 32 GB internal memory, partly used by operating system
- 1 x HDMI 1.4
- 2 x USB 2.0
- 1 x USB 3.0
- 1 x LAN RJ45
- Dual-band WLAN
- Stand-by power max. 2 W, full load max. 7 W
- Plug-in power supply 100 ... 240 V AC / 5 V DC / 2 A (included in delivery)
- The visualization can be realized with devices with a browser suitable for HTML5 (e.g. latest version of Chrome, Firefox or Safari)
- Access from max. 10 different clients possible





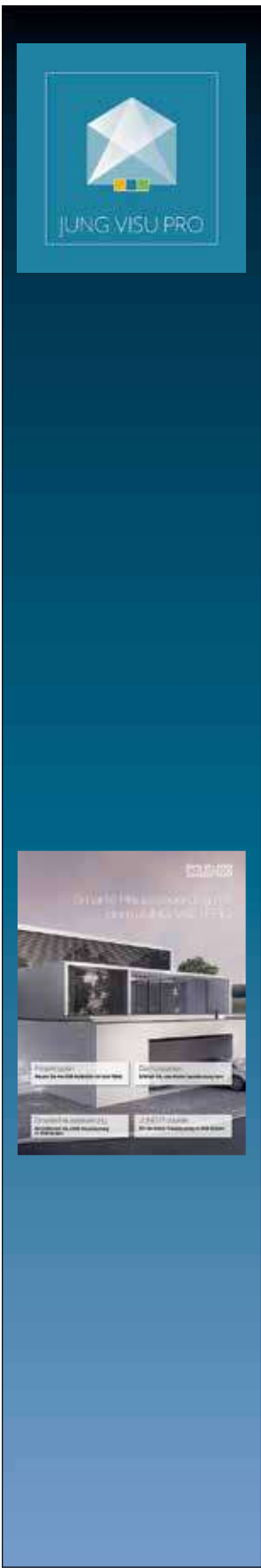

	Ref.-no.
<b>JUNG Visu Pro software</b>	
Full version	<b>JVP-V</b>
Planner version	<b>JVP-P</b>

**Note:** The software can only be downloaded from the JUNG website [www.jung.de](http://www.jung.de). When downloading, you can choose between the English and the German version. Each installation will run in demo mode for 20 days or 400 starts. For an unrestricted use the software must be activated via a MyJUNG account.

**Intended use**

- Visualization and operation of system statuses and information on building automation
- The visualization can be realized with devices with a browser suitable for HTML5 (e.g. latest version of Chrome, Firefox or Safari)
- Access from max. 25 different clients possible

**Requirements**

**Hardware**

as Visu Pro Server (ref.-no.: JVP-SERVER-H-GB) or better  
 Please note: The performance of the hardware is one of the limiting factors for the project size.

**Operating systems**

Windows 7 Home, Professional and Ultimate (32- and 64-bit) or higher, not Windows 2008 or 2012 Server

**Process connection**

The Falcon driver of the KNX Association is used for the KNX bus. The KNX connection requires a suitable version of the Falcon driver and the respective interfaces.

An optional OPC client for the visualization allows the use of an OPC server instead of / in addition to KNX.

**Data import from ETS**

ETS5: use of project export of ETS	ETS2 version 1.1, 1.2 and 1.3: files generated
ETS4: use of project export of ETS	by "print export" can be read
ETS3: use of OPC export of ETS	Previous ETS versions: not possible

**Software**

Falcon driver 2.2	Internet Explorer
DirectX, version 9.0c	.NET framework 3.5 SP1

**JUNG App Visu Pro**

App for remote control of all JUNG KNX devices with integrated Visu Pro software: You can control all functions with your iPad in a convenient and flexible way. The clearly structured visualization ensures an intuitive operation. In addition to controlling your own KNX installation the app also includes a demo version. The free App "Visu Pro" can only be downloaded from the iTunes Store.

**Smart Assistant**

<b>SMART-ASSIST</b>
---------------------

**Note:** The software can only be downloaded from the JUNG website [www.jung.de](http://www.jung.de).

For an unrestricted use the software must be activated via a MyJUNG account.

Smart Assistant is a planning tool for the simple creation of visualization projects for the JUNG Visu Pro software or other automation applications such as iHaus. The use of conventions and schemes (trade, floor, room, function) does not require knowledge of KNX group addresses.

Export formats are available for JUNG Visu Pro software, iHaus and ETS group addresses.

**Requirements**

Server/client-based software, but can be used with one PC

Operating systems for server: Windows 7 Home, Professional and Ultimate (32- and 64-bit) or higher, not Windows 2008 or 2012 Server

Clients: Browser suitable for HTML5 (e.g. latest version of Chrome, Firefox or Safari)

	Ref.-no.
<b>Bus connection block</b>	
red/black (for KNX)	<b>2050 RT SW</b>
yellow/white	<b>2050 GE WS</b>
<b>Connection cover</b> for bus terminal of rail mounting devices	
	<b>2050 K</b>
<b>Product data base</b> Database for ETS	
<b>Button lever</b> for the simple and gentle deinstallation of rockers and covers	
	<b>W-KEIL</b>

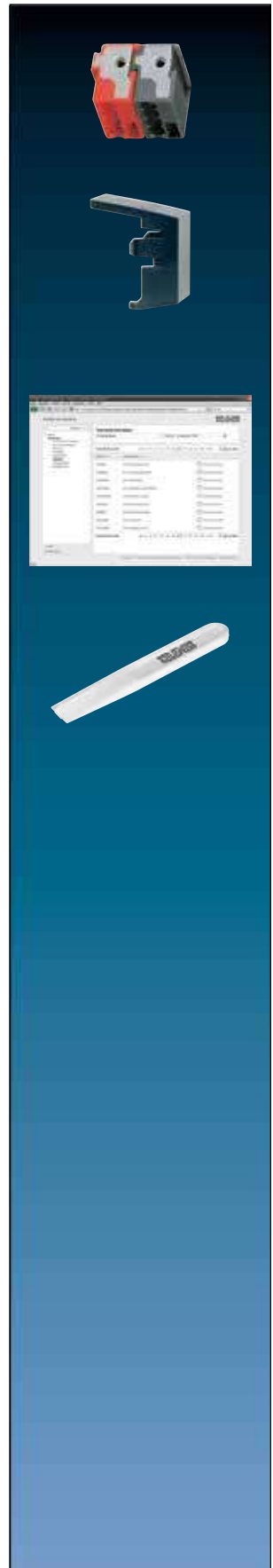



**SMART CONTROL 7**  
as video intercom station

# Door communication and KNX

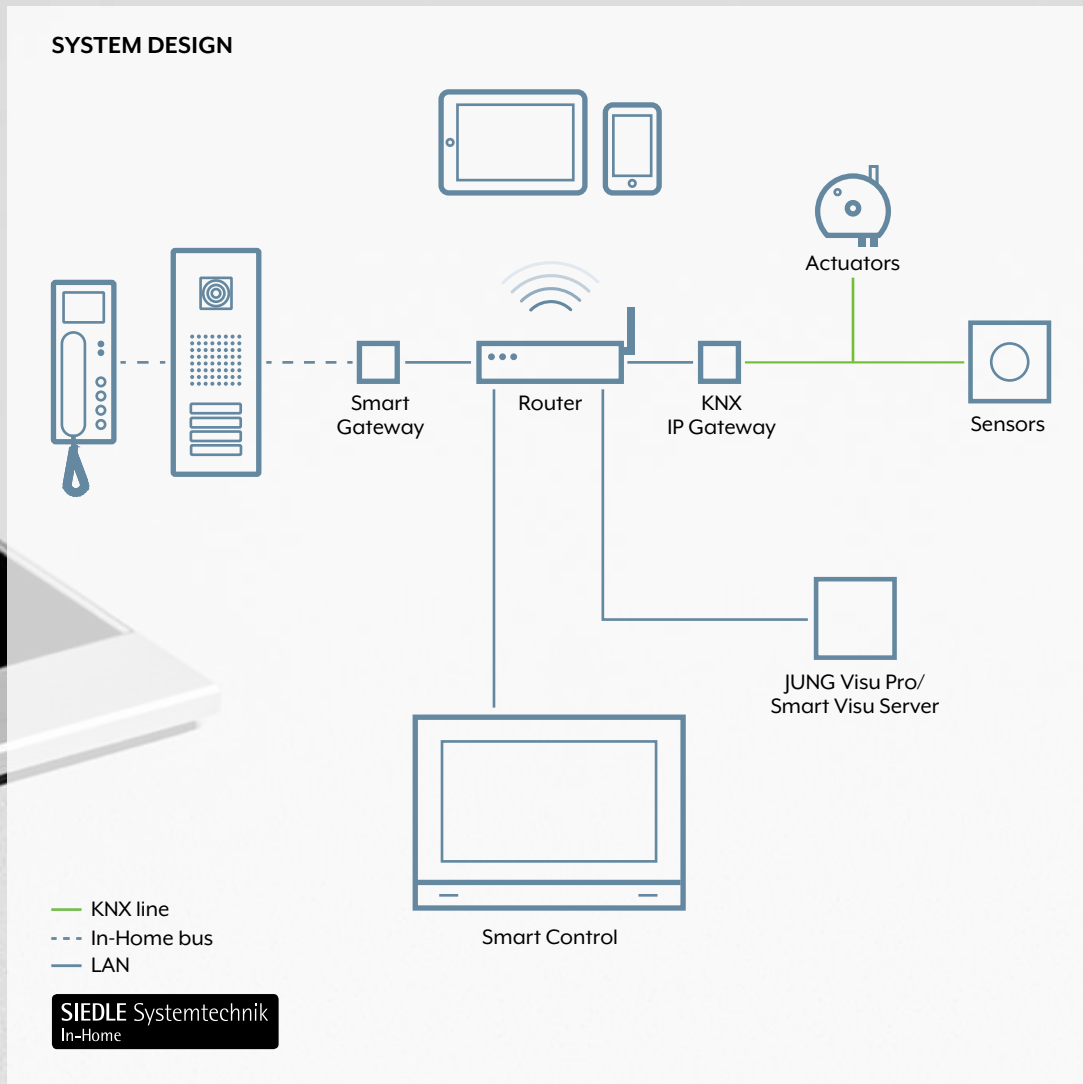

Combined operation of building system technology and building communication – for greater security and convenience: The Siedle Smart Gateway functions as interface to the door communication in a KNX installation. The JUNG KNX Smart Controls 7, 10, 15 and 19 and smart devices become intuitively usable video intercom stations using this.

# Index

Ref.-no.	Page
20160 REG	148
20320 REG	149
2050 GE WS	263
2050 K	263
2050 RT SW	263
20640 REG	149
2073 U	128
2076-2 T	204
2076-4 T	205
2096 LUX	120
2099 REGHE	161
2103 REG ES	208
2116 REG	202
2128 REG	203
21280 REG	150
2130 USB	153
2130 USB REG	153
2131.16 UP	194
2132.6 UP	195
2142 REG	157
2177 SV R	200
2178	139
2178 ORTS	143
2178 TS	141
2194 REGHM	181
2204.01 REGA	186
2204.01 REGAM	187
2214 REG A	225
2214 REGAM	226
2224 WH	224
2225 BFA	223
2225 WS U	222
2302.16 REGHM	164
2304.16 REGCHM	167
2304.16 REGHE	169
2304.16 REGHM	165
23066 REGHE	190e
2308.16 REGCHM	168
2308.16 REGHE	170
2308.16 REGHM	166
2316.16 REGHE	171
2336 REG HZ HE	184
2336 REG HZR HE	185
2424 REGHE	172
2501 HZ UP	199
2501 UP	197
2502 REGHE	172
2504 REGHE	173
2504 REGHER	175
2508 REGHE	174
2514 REGHE	173
2531 UP	196
28	233
28 G1	233
28 G1 SL	233
3210 UP	198
33 AN K	115
33 AN L	115
33 AN N	115
33 AN T	115
33 GN	115
33 KLAR	115
33 NR	115
3361 AL	124
3361 M WW	118
3361 WW	124
3361-1 AL	124
3361-1 M WW	118
3361-1 WW	124
3901 REGHE	176
3902 REGHE	177
3904 EB LED	180
3904 REG LED	179
3904 REGHE	178

Ref.-no.	Page
4071 RF TSM	85
4071 TSM	60
4071.01 LED	98
4071.02 LED	98
4072 RF TSM	85
4072 TSM	60
4072.01 LED	105
4072.02 LED	105
4073 RF TSM	85
4073 TSM	60
4074 RF TSM	86
4074 TSM	61
4091 TSEM	62
4092 TSEM	62
4093 KRM TS D	72
4093 TSEM	62
4094 TSEM	62
4191 TSM	61
4192 TSM	61
4193 TSM	62
4194 TSM	62
569 T	154
569 TNA	154
800 KO	114
800 NA	114
800 NT	114
800 P	114
805 MP	115
805 NT	115
805 P	115
8471.01 LED W	114
8471.02 LED W	114
8472.01 LED W	115
8472.02 LED W	115
A 1540 BF KO5 ANM	93
A 1540 BF KO5 SW	93
A 1540 BF KO5 WW	93
A 1540 KO5	93
A 1540 KO5 AL	93
A 1540 KO5 CH	93
A 1540 KO5 MO	93
A 1540 KO5 SW	93
A 1540 KO5 WW	93
A 2178	139
A 2178 AL	139
A 2178 ANM	139
A 2178 BF ORTS ANM	143
A 2178 BF ORTS SW	143
A 2178 BF ORTS WW	143
A 2178 CH	139
A 2178 MO	139
A 2178 ORTS	143
A 2178 ORTS AL	143
A 2178 ORTS CH	143
A 2178 ORTS MO	143
A 2178 ORTS SW	143
A 2178 ORTS WW	143
A 2178 SW	139
A 2178 TS	141
A 2178 TS AL	141
A 2178 TS ANM	141
A 2178 TS CH	141
A 2178 TS MO	141
A 2178 TS SW	141
A 2178 TS WW	141
A 2178 WW	139
A 3181	128
A 3181 AL	128
A 3181 ANM	128
A 3181 CH	128
A 3181 MO	128
A 3181 SW	128
A 3181 WW	128
A 3181-1	129

Ref.-no.	Page
A 3181-1 AL	129
A 3181-1 ANM	129
A 3181-1 CH	129
A 3181-1 MO	129
A 3181-1 SW	129
A 3181-1 WW	129
A 3281	130
A 3281 AL	130
A 3281 ANM	130
A 3281 CH	130
A 3281 MO	130
A 3281 SW	130
A 3281 WW	130
A 3281-1	130
A 3281-1 AL	130
A 3281-1 ANM	130
A 3281-1 CH	130
A 3281-1 MO	130
A 3281-1 SW	130
A 3281-1 WW	130
A 401 TSA	63
A 401 TSA AL	63
A 401 TSA ANM	63
A 401 TSA CH	63
A 401 TSA MO	63
A 401 TSA SW	63
A 401 TSA WW	63
A 401 TSAP	64
A 401 TSAP AL	64
A 401 TSAP ANM	64
A 401 TSAP CH	64
A 401 TSAP MO	64
A 401 TSAP SW	64
A 401 TSAP WW	64
A 402 TSA	63
A 402 TSA AL	63
A 402 TSA ANM	63
A 402 TSA CH	63
A 402 TSA MO	63
A 402 TSA SW	63
A 402 TSA WW	63
A 402 TSAP	64
A 402 TSAP AL	64
A 402 TSAP ANM	64
A 402 TSAP CH	64
A 402 TSAP MO	64
A 402 TSAP SW	64
A 402 TSAP WW	64
A 403 TSA	63
A 403 TSA AL	63
A 403 TSA ANM	63
A 403 TSA CH	63
A 403 TSA MO	63
A 403 TSA SW	63
A 403 TSA WW	63
A 404 TSA	63
A 404 TSA AL	63
A 404 TSA ANM	63
A 404 TSA CH	63
A 404 TSA MO	63
A 404 TSA SW	63
A 404 TSA WW	63
A 404 TSAP 14	64
A 404 TSAP 23	64
A 404 TSAP AL 14	64
A 404 TSAP AL 23	64
A 404 TSAP ANM 14	64
A 404 TSAP ANM 23	64
A 404 TSAP CH 14	64
A 404 TSAP CH 23	64
A 404 TSAP MO 14	64
A 404 TSAP MO 23	64
A 404 TSAP SW 14	64
A 404 TSAP SW 23	64

Ref.-no.	Page
A 404 TSAP WW 14	64
A 404 TSAP WW 23	64
A 409 T	73
A 4093 TSA	73
A 4093 TSA AL	73
A 4093 TSA ANM	73
A 4093 TSA CH	73
A 4093 TSA MO	73
A 4093 TSA SW	73
A 4093 TSA WW	73
A 50 NA	37
A 50 NA AL	37
A 50 NA ANM	37
A 50 NA CH	37
A 50 NA MO	37
A 50 NA SW	37
A 50 NA W	37
A 50 NA WW	37
A 501 TSA	36
A 501 TSA AL	36
A 501 TSA ANM	36
A 501 TSA CH	36
A 501 TSA MO	36
A 501 TSA SW	36
A 501 TSA WW	36
A 502 TSA	36
A 502 TSA AL	36
A 502 TSA ANM	36
A 502 TSA CH	36
A 502 TSA MO	36
A 502 TSA SW	36
A 502 TSA WW	36
A 503 TSA	36
A 503 TSA AL	36
A 503 TSA ANM	36
A 503 TSA CH	36
A 503 TSA MO	36
A 503 TSA SW	36
A 503 TSA WW	36
A 504 TSA	37
A 504 TSA AL	37
A 504 TSA ANM	37
A 504 TSA CH	37
A 504 TSA MO	37
A 504 TSA SW	37
A 504 TSA WW	37
A 5071 RF TSM	82
A 5071 TSM	32
A 5072 RF TSM	82
A 5072 TSM	32
A 5073 RF TSM	82
A 5073 TSM	32
A 5074 RF TSM	83
A 5074 TSM	32
A 5091 TSEM	34
A 5091 TSM	33
A 5092 TSEM	34
A 5092 TSM	33
A 5093 TSEM	34
A 5093 TSM	33
A 5094 TSEM	34
A 5094 TSM	33
A 5178 TSEM	35
A 5178 TSM	34
A 5192 KRM TS D	35
A 5194 KRM TS D	35
A 569 BFPLT	154
A 569 BFPLT ANM	154
A 569 BFPLT SW	154
A 569 BFPLT WW	154
A 569 PLT	154
A 569 PLT AL	154
A 569 PLT CH	154
A 569 PLT MO	154

Ref.-no.	Page
A 569 PLT SW	154
A 569 PLT WW	154
A 590 AL	99
A 590 BF ANM	99
A 590 BF KO5 ANM	100
A 404 TSAP WW 14	64
A 404 TSAP WW 23	64
A 409 T	73
A 4093 TSA	73
A 4093 TSA AL	73
A 4093 TSA ANM	73
A 4093 TSA CH	73
A 4093 TSA MO	73
A 4093 TSA SW	73
A 4093 TSA WW	73
A 50 NA	37
A 50 NA AL	37
A 50 NA ANM	37
A 50 NA CH	37
A 50 NA MO	37
A 50 NA SW	37
A 50 NA W	37
A 50 NA WW	37
A 501 TSA	36
A 501 TSA AL	36
A 501 TSA ANM	36
A 501 TSA CH	36
A 501 TSA MO	36
A 501 TSA SW	36
A 501 TSA WW	36
A 502 TSA	36
A 502 TSA AL	36
A 502 TSA ANM	36
A 502 TSA CH	36
A 502 TSA MO	36
A 502 TSA SW	36
A 502 TSA WW	36
A 503 TSA	36
A 503 TSA AL	36
A 503 TSA ANM	36
A 503 TSA CH	36
A 503 TSA MO	36
A 503 TSA SW	36
A 503 TSA WW	36
A 504 TSA	37
A 504 TSA AL	37
A 504 TSA ANM	37
A 504 TSA CH	37
A 504 TSA MO	37
A 504 TSA SW	37
A 504 TSA WW	37
A 5071 RF TSM	82
A 5071 TSM	32
A 5072 RF TSM	82
A 5072 TSM	32
A 5073 RF TSM	82
A 5073 TSM	32
A 5074 RF TSM	83
A 5074 TSM	32
A 5091 TSEM	34
A 5091 TSM	33
A 5092 TSEM	34
A 5092 TSM	33
A 5093 TSEM	34
A 5093 TSM	33
A 5094 TSEM	34
A 5094 TSM	33
A 5178 TSEM	35
A 5178 TSM	34
A 5192 KRM TS D	35
A 5194 KRM TS D	35
A 569 BFPLT	154
A 569 BFPLT ANM	154
A 569 BFPLT SW	154
A 569 BFPLT WW	154
A 569 PLT	154
A 569 PLT AL	154
A 569 PLT CH	154
A 569 PLT MO	154

Ref.-no.	Page
A 569 PLT SW	154
A 569 PLT WW	154
A 590 AL	99
A 590 BF ANM	99
A 590 BF KO5 ANM	100
A 590 BF KO5 SW	100
A 590 BF KO5 WW	100
A 590 BF KO5P ANM	100
A 590 BF KO5P SW	100
A 590 BF KO5P WW	100
A 590 BF P ANM	99
A 590 BF P SW	99
A 590 BF P WW	99
A 590 BF SW	99
A 590 BF WW	99
A 590 CH	99
A 590 KO5 AL	100
A 590 KO5 CH	100
A 590 KO5 MO	100
A 590 KO5 SW	100
A 590 KO5 WW	100
A 590 KO5P AL	100
A 590 KO5P CH	100
A 590 KO5P MO	100
A 590 KO5P SW	100
A 590 KO5P WW	100
A 590 MO	99
A 590 P AL	99
A 590 P CH	99
A 590 P MO	99
A 590 P SW	99
A 590 P WW	99
A 590 SW	99
A 590 WW	99
A 595 AL	106
A 595 BF ANM	106
A 595 BF KO5 ANM	107
A 595 BF KO5 SW	107
A 595 BF KO5 WW	107
A 595 BF KO5MP ANM	108
A 595 BF KO5MP SW	108
A 595 BF KO5MP WW	108
A 595 BF KO5P ANM	108
A 595 BF KO5P SW	108
A 595 BF KO5P WW	108
A 595 BF MP ANM	107
A 595 BF MP SW	107
A 595 BF MP WW	107
A 595 BF P ANM	107
A 595 BF P SW	107
A 595 BF P WW	107
A 595 BF SW	106
A 595 BF WW	106
A 595 CH	106
A 595 KO5 AL	107
A 595 KO5 CH	107
A 595 KO5 MO	107
A 595 KO5 SW	107
A 595 KO5 WW	107
A 595 KO5MP AL	108
A 595 KO5MP CH	108
A 595 KO5MP MO	108
A 595 KO5MP SW	108
A 595 KO5MP WW	108
A 595 KO5P AL	108
A 595 KO5P CH	108
A 595 KO5P MO	108
A 595 KO5P SW	108
A 595 KO5P WW	108
A 595 MO	106
A 595 MP AL	107
A 595 MP CH	107
A 595 MP MO	107
A 595 MP SW	107
A 595 MP WW	107
A 595 P AL	107
A 595 P CH	107
A 595 P MO	107
A 595 P SW	107

Ref.-no.	Page
A 595 P WW	107
A 595 SW	106
A 595 WW	106
ABL/S2.1	157
AL 1940 KO5	93
AL 1940 KO5 AN	93
AL 2178	139
AL 2178 AN	139
AL 2178 ORTS	143
AL 2178 ORTS AN	143
AL 2178 TS	141
AL 2178 TS AN	141
AL 2178 TS D	141
AL 2401 TSA	67
AL 2401 TSA AN	67
AL 2401 TSA D	67
AL 2401 TSAP	68
AL 2401 TSAP AN	68
AL 2401 TSAP D	68
AL 2402 TSA	67
AL 2402 TSA AN	67
AL 2402 TSA D	67
AL 2402 TSAP	68
AL 2402 TSAP AN	68
AL 2402 TSAP D	68
AL 2403 TSA	67
AL 2403 TSA AN	67
AL 2403 TSA D	67
AL 2404 TSA	68
AL 2404 TSA AN	68
AL 2404 TSA D	68
AL 2404 TSAP 14	69
AL 2404 TSAP 23	69
AL 2404 TSAP AN 14	69
AL 2404 TSAP AN 23	69
AL 2404 TSAP D 14	69
AL 2404 TSAP D 23	69
AL 2501 TSA	48
AL 2501 TSA AN	48
AL 2501 TSA D	48
AL 2502 TSA	48
AL 2502 TSA AN	48
AL 2502 TSA D	48
AL 2503 TSA	48
AL 2503 TSA AN	48
AL 2503 TSA D	48
AL 2504 TSA	49
AL 2504 TSA AN	49
AL 2504 TSA D	49
AL 2969 T	154
AL 2969 T AN	154
AL 2969 T D	154
AL 2990	103
AL 2990 AN	103
AL 2990 D	103
AL 2990 KO5	104
AL 2990 KO5 AN	104
AL 2990 KO5 D	104
AL 2990 KO5P	104
AL 2990 KO5P AN	104
AL 2990 NA	104
AL 2990 NA AN	104
AL 2990 NA D	104
AL 2990 P	103
AL 2990 P AN	103
AL 2995	112
AL 2995 AN	112
AL 2995 D	112
AL 2995 KO5	113
AL 2995 KO5 AN	113
AL 2995 KO5 D	113
AL 2995 KO5MP	113
AL 2995 KO5MP AN	113
AL 2995 KO5P	113
AL 2995 KO5P AN	113
AL 2995 MP	112
AL 2995 MP AN	112
AL 2995 P	112
AL 2995 P AN	112

Ref.-no.	Page
AL 2995 P D	112
AL 3181	129
AL 3181 AN	129
AL 3181 D	129
AL 3181-1	129
AL 3181-1 AN	129
AL 3181-1 D	129
AL 3281	131
AL 3281 AN	131
AL 3281 D	131
AL 3281-1	131
AL 3281-1 AN	131
AL 3281-1 D	131
AL 4093 TSA	75
AL 4093 TSA AN	75
AL 4093 TSA D	75
AL 50 NA AN-L	49
AL 50 NA D-L	49
AL 50 NA-L	49
AS 590	98
AS 590 KO5	98
AS 590 KO5 WW	98
AS 590 KO5P	99
AS 590 KO5P WW	99
AS 590 P	98
AS 590 P WW	98
AS 590 WW	98
AS 590-5	105
AS 590-5 KO5	106
AS 590-5 KO5 WW	106
AS 590-5 KO5MP	106
AS 590-5 KO5MP WW	106
AS 590-5 KO5P	106
AS 590-5 KO5P WW	106
AS 590-5 MP	105
AS 590-5 MP WW	105
AS 590-5 P	105
AS 590-5 P WW	105
AS 590-5 WW	105
AS 591	98
AS 591 KO5	98
AS 591 KO5 WW	98
AS 591 KO5P	99
AS 591 KO5P WW	99
AS 591 P	98
AS 591 P WW	98
AS 591 WW	98
AS 591-5	105
AS 591-5 KO5	106
AS 591-5 KO5 WW	106
AS 591-5 KO5MP	106
AS 591-5 KO5MP WW	106
AS 591-5 KO5P	106
AS 591-5 KO5P WW	106
AS 591-5 MP	105
AS 591-5 MP WW	105
AS 591-5 P	105
AS 591-5 P WW	105
AS 591-5 WW	105
BGA 12 AH	152
BTS 01	199
CD 1540 KO5	93
CD 1540 KO5 GR	93
CD 1540 KO5 LG	93
CD 1540 KO5 SW	93
CD 1540 KO5 WW	93
CD 2178 GR	139
CD 2178 LG	139
CD 2178 ORTS GR	143
CD 2178 ORTS LG	143
CD 2178 ORTS SW	143
CD 2178 ORTS WW	143
CD 2178 SW	139
CD 2178 TS GR	141
CD 2178 TS LG	141
CD 2178 TS SW	141
CD 2178 TS WW	141
CD 2178 WW	139
CD 3181	129

Ref.-no.	Page
CD 3181 GR	129
CD 3181 LG	129
CD 3181 SW	129
CD 3181 WW	129
CD 3181-1	129
CD 3181-1 GR	129
CD 3181-1 LG	129
CD 3181-1 SW	129
CD 3181-1 WW	129
CD 3281	131
CD 3281 GR	131
CD 3281 LG	131
CD 3281 SW	131
CD 3281 WW	131
CD 3281-1	131
CD 3281-1 GR	131
CD 3281-1 LG	131
CD 3281-1 SW	131
CD 3281-1 WW	131
CD 4 AR	66
CD 401 TSA	65
CD 401 TSA GR	65
CD 401 TSA LG	65
CD 401 TSA SW	65
CD 401 TSA WW	65
CD 401 TSAP	66
CD 401 TSAP GR	66
CD 401 TSAP LG	66
CD 401 TSAP SW	66
CD 401 TSAP WW	66
CD 402 TSA	65
CD 402 TSA GR	65
CD 402 TSA LG	65
CD 402 TSA SW	65
CD 402 TSA WW	65
CD 402 TSAP	66
CD 402 TSAP GR	66
CD 402 TSAP LG	66
CD 402 TSAP SW	66
CD 402 TSAP WW	66
CD 403 TSA	65
CD 403 TSA GR	65
CD 403 TSA LG	65
CD 403 TSA SW	65
CD 403 TSA WW	65
CD 404 TSA	65
CD 404 TSA GR	65
CD 404 TSA LG	65
CD 404 TSA SW	65
CD 404 TSA WW	65
CD 404 TSAP 14	66
CD 404 TSAP 23	66
CD 404 TSAP GR 14	66
CD 404 TSAP GR 23	66
CD 404 TSAP LG 14	66
CD 404 TSAP LG 23	66
CD 404 TSAP SW 14	66
CD 404 TSAP SW 23	66
CD 404 TSAP WW 14	66
CD 404 TSAP WW 23	66
CD 409 T	74
CD 4093 TSA	74
CD 4093 TSA GR	74
CD 4093 TSA LG	74
CD 4093 TSA SW	74
CD 4093 TSA WW	74
CD 50 NA	43
CD 50 NA GR	43
CD 50 NA LG	43
CD 50 NA SW	43
CD 50 NA W	43
CD 50 NA WW	43
CD 501 TSA	42
CD 501 TSA GR	42
CD 501 TSA LG	42
CD 501 TSA SW	42
CD 501 TSA WW	42
CD 502 TSA	42
CD 502 TSA GR	42

Ref.-no.	Page
CD 502 TSA LG	42
CD 502 TSA SW	42
CD 502 TSA WW	42
CD 503 TSA	42
CD 503 TSA GR	42
CD 503 TSA LG	42
CD 503 TSA SW	42
CD 503 TSA WW	42
CD 504 TSA	42
CD 504 TSA GR	42
CD 504 TSA LG	42
CD 504 TSA SW	42
CD 504 TSA WW	42
CD 5071 RF TSM	83
CD 5071 TSM	38
CD 5072 RF TSM	83
CD 5072 TSM	38
CD 5073 RF TSM	83
CD 5073 TSM	38
CD 5074 RF TSM	83
CD 5074 TSM	38
CD 5091 TSEM	40
CD 5091 TSM	39
CD 5092 TSEM	40
CD 5092 TSM	39
CD 5093 TSEM	40
CD 5093 TSM	39
CD 5094 TSEM	40
CD 5094 TSM	39
CD 5178 TSEM	41
CD 5178 TSM	40
CD 5192 KRM TS D	41
CD 5194 KRM TS D	41
CD 569 T GR	154
CD 569 T LG	154
CD 569 T SW	154
CD 569 T WW	154
CD 569 TNA WW	154
CD 590	100
CD 590 BR	100
CD 590 GB	100
CD 590 GR	100
CD 590 KO5	101
CD 590 KO5 BR	101
CD 590 KO5 GB	101
CD 590 KO5 GR	101
CD 590 KO5 LG	101
CD 590 KO5 PT	101
CD 590 KO5 SW	101
CD 590 KO5 WW	101
CD 590 KO5P	102
CD 590 KO5P BR	102
CD 590 KO5P GB	102
CD 590 KO5P GR	102
CD 590 KO5P LG	102
CD 590 KO5P PT	102
CD 590 KO5P SW	102
CD 590 KO5P WW	102
CD 590 LG	100
CD 590 NA	101
CD 590 NA BR	101
CD 590 NA GR	101
CD 590 NA LG	101
CD 590 NA SW	101
CD 590 NA WW	101
CD 590 NAKO5	102
CD 590 NAKO5 BR	102
CD 590 NAKO5 GR	102
CD 590 NAKO5 LG	102
CD 590 NAKO5 SW	102
CD 590 NAKO5 WW	102
CD 590 P	101
CD 590 P BR	101
CD 590 P GB	101
CD 590 P GR	101
CD 590 P LG	101
CD 590 P PT	101
CD 590 P SW	101
CD 590 P WW	101

Ref.-no.	Page
CD 590 PT	100
CD 590 SW	100
CD 590 WW	100
CD 595	109
CD 595 BR	109
CD 595 GB	109
CD 595 GR	109
CD 595 KO5	110
CD 595 KO5 BR	110
CD 595 KO5 GB	110
CD 595 KO5 GR	110
CD 595 KO5 LG	110
CD 595 KO5 PT	110
CD 595 KO5 SW	110
CD 595 KO5 WW	110
CD 595 KO5MP	110
CD 595 KO5MP BR	110
CD 595 KO5MP GB	110
CD 595 KO5MP GR	110
CD 595 KO5MP LG	110
CD 595 KO5MP PT	110
CD 595 KO5MP SW	110
CD 595 KO5MP WW	110
CD 595 KO5P BR	110
CD 595 KO5P GB	110
CD 595 KO5P GR	110
CD 595 KO5P LG	110
CD 595 KO5P PT	110
CD 595 KO5P SW	110
CD 595 KO5P WW	110
CD 595 LG	109
CD 595 MP	109
CD 595 MP BR	109
CD 595 MP GB	109
CD 595 MP GR	109
CD 595 MP LG	109
CD 595 MP PT	109
CD 595 MP SW	109
CD 595 MP WW	109
CD 595 P	109
CD 595 P BR	109
CD 595 P GB	109
CD 595 P GR	109
CD 595 P LG	109
CD 595 P PT	109
CD 595 P SW	109
CD 595 P WW	109
CD 595 PT	109
CD 595 SW	109
CD 595 WW	109
CD 90 NA	101
CO2 A 2178	145
CO2 A 2178 AL	145
CO2 A 2178 BF ANM	145
CO2 A 2178 BF SW	145
CO2 A 2178 BF WW	145
CO2 A 2178 CH	145
CO2 A 2178 MO	145
CO2 A 2178 SW	145
CO2 A 2178 WW	145
CO2 AL 2178	145
CO2 AL 2178 AN	145
CO2 AL 2178 D	145
CO2 CD 2178	145
CO2 CD 2178 GR	145
CO2 CD 2178 LG	145
CO2 CD 2178 SW	145
CO2 CD 2178 WW	145
CO2 ES 2178	145
CO2 GCR 2178	145
CO2 LS 2178	145
CO2 LS 2178 LG	145
CO2 LS 2178 SW	145
CO2 LS 2178 WW	145
CO2 ME 2178 AT	145
CO2 ME 2178 C	145
DAS 4120	231
DAS 4210	232

Ref.-no.	Page
DAS 4300 A	233
DAS 4300 U	233
DAS 4360	235
DAS 4370	234
DS 4092 TS	92
EBG 24	241
EBG 2424	237
ES 1940 KO5	93
ES 2178	139
ES 2178 ORTS	143
ES 2178 TS	141
ES 2401 TSA	67
ES 2401 TSAP	68
ES 2402 TSA	67
ES 2402 TSAP	68
ES 2403 TSA	67
ES 2404 TSA	68
ES 2404 TSAP 14	69
ES 2404 TSAP 23	69
ES 2501 TSA	48
ES 2502 TSA	48
ES 2503 TSA	48
ES 2504 TSA	49
ES 2969 T	154
ES 2990	103
ES 2990 KO5	104
ES 2990 KO5P	104
ES 2990 NA	104
ES 2990 P	103
ES 2995	112
ES 2995 KO5	113
ES 2995 KO5MP	113
ES 2995 KO5P	113
ES 2995 MP	112
ES 2995 P	112
ES 3181	129
ES 3181-1	129
ES 3281	131
ES 3281-1	131
ES 4093 TSA	75
ES 50 NA-L	49
FCA 2 REGHE	182
FP AL 781	241
FP ES 781	241
FP GLAS 781	241
FP GLAS 781 SW	241
FP GLAS 781 WW	241
FPI 781 AN	241
FUS 4410 BR	235
FUS 4410 WW	235
FUS 4415 WW	235
GCR 1940 KO5	93
GCR 2178	139
GCR 2178 ORTS	143
GCR 2178 TS	141
GCR 2501 TSA	48
GCR 2502 TSA	48
GCR 2503 TSA	48
GCR 2504 TSA	49
GCR 2969 T	154
GCR 2990	103
GCR 2990 KO5	104
GCR 2995	112
GCR 2995 KO5	113
GCR 2995 P	112
GO 1940 KO5	93
GO 2501 TSA	48
GO 2502 TSA	48
GO 2503 TSA	48
GO 2504 TSA	49
GO 2990	103
GO 2990 KO5	104
GO 2995	112
GO 2995 KO5	113
GO 2995 P	112
HS 2 RF	86
HS 4 RF	86
IPR 200 REG	156
IPS 200 REG	156



Ref.-no.	Page	Ref.-no.	Page	Ref.-no.	Page	Ref.-no.	Page
CD 590 PT	100	DAS 4300 A	233	JVP-P	260	LS 50 NA	49
CD 590 SW	100	DAS 4300 U	233	JVP-SERVER-H	259	LS 50 NA LG	49
CD 590 WW	100	DAS 4360	235	JVP-SERVER-P	259	LS 50 NA SW	49
CD 595	109	DAS 4370	234	JVP-V	260	LS 50 NA W	49
CD 595 BR	109	DS 4092 TS	92	KNX LINKIT	261	LS 50 NA WW	49
CD 595 GB	109	EBG 24	241	KNX PM FB IR	120	LS 501 TSA	48
CD 595 GR	109	EBG 2424	237	KSB 4	152	LS 501 TSA GGO	48
CD 595 KO5	110	ES 1940 KO5	93	KSE 2	152	LS 501 TSA LG	48
CD 595 KO5 BR	110	ES 2178	139	LES 01	199	LS 501 TSA SW	48
CD 595 KO5 GB	110	ES 2178 ORTS	143	LS 1940 KO5	93	LS 501 TSA WW	48
CD 595 KO5 GR	110	ES 2178 TS	141	LS 1940 KO5 LG	93	LS 502 TSA	48
CD 595 KO5 LG	110	ES 2401 TSA	67	LS 1940 KO5 SW	93	LS 502 TSA GGO	48
CD 595 KO5 PT	110	ES 2401 TSAP	68	LS 1940 KO5 WW	93	LS 502 TSA LG	48
CD 595 KO5 SW	110	ES 2402 TSA	67	LS 2178	139	LS 502 TSA SW	48
CD 595 KO5 WW	110	ES 2402 TSAP	68	LS 2178 LG	139	LS 502 TSA WW	48
CD 595 KO5MP	110	ES 2403 TSA	67	LS 2178 ORTS	143	LS 503 TSA	48
CD 595 KO5MP BR	110	ES 2404 TSA	68	LS 2178 ORTS LG	143	LS 503 TSA GGO	48
CD 595 KO5MP GB	110	ES 2404 TSAP 14	69	LS 2178 ORTS SW	143	LS 503 TSA LG	48
CD 595 KO5MP GR	110	ES 2404 TSAP 23	69	LS 2178 ORTS WW	143	LS 503 TSA SW	48
CD 595 KO5MP LG	110	ES 2501 TSA	48	LS 2178 SW	139	LS 503 TSA WW	48
CD 595 KO5MP PT	110	ES 2502 TSA	48	LS 2178 TS	141	LS 504 TSA	49
CD 595 KO5MP SW	110	ES 2503 TSA	48	LS 2178 TS LG	141	LS 504 TSA GGO	49
CD 595 KO5MP WW	110	ES 2504 TSA	49	LS 2178 TS SW	141	LS 504 TSA LG	49
CD 595 KO5P	110	ES 2969 T	154	LS 2178 TS WW	141	LS 504 TSA SW	49
CD 595 KO5P BR	110	ES 2990	103	LS 2178 WW	139	LS 504 TSA WW	49
CD 595 KO5P GB	110	ES 2990 KO5	104	LS 3181	129	LS 5071 RF TSM	84
CD 595 KO5P GR	110	ES 2990 KO5P	104	LS 3181 LG	129	LS 5071 TSM	44
CD 595 KO5P LG	110	ES 2990 NA	104	LS 3181 SW	129	LS 5072 RF TSM	84
CD 595 KO5P PT	110	ES 2990 P	103	LS 3181 WW	129	LS 5072 TSM	44
CD 595 KO5P SW	110	ES 2995	112	LS 3181-1	129	LS 5073 RF TSM	84
CD 595 KO5P WW	110	ES 2995 KO5	113	LS 3181-1 LG	129	LS 5073 TSM	44
CD 595 LG	109	ES 2995 KO5MP	113	LS 3181-1 SW	129	LS 5074 RF TSM	84
CD 595 MP	109	ES 2995 KO5P	113	LS 3181-1 WW	129	LS 5074 TSM	44
CD 595 MP BR	109	ES 2995 MP	112	LS 3281	131	LS 5091 TSEM	46
CD 595 MP GB	109	ES 2995 P	112	LS 3281 LG	131	LS 5091 TSM	45
CD 595 MP GR	109	ES 3181	129	LS 3281 SW	131	LS 5092 TSEM	46
CD 595 MP LG	109	ES 3181-1	129	LS 3281 WW	131	LS 5092 TSM	45
CD 595 MP PT	109	ES 3281	131	LS 3281-1	131	LS 5093 TSEM	46
CD 595 MP SW	109	ES 3281-1	131	LS 3281-1 LG	131	LS 5093 TSM	45
CD 595 MP WW	109	ES 4093 TSA	75	LS 3281-1 SW	131	LS 5094 TSEM	46
CD 595 P	109	ES 50 NA-L	49	LS 3281-1 WW	131	LS 5094 TSM	45
CD 595 P BR	109	FCA 2 REGHE	186	LS 4 AR	69	LS 5178 TSEM	47
CD 595 P GB	109	FP AL 781	241	LS 401 TSA	67	LS 5178 TSM	46
CD 595 P GR	109	FP ES 781	241	LS 401 TSA LG	67	LS 5192 KRM TS D	47
CD 595 P LG	109	FP GLAS 781	241	LS 401 TSA SW	67	LS 5194 KRM TS D	47
CD 595 P PT	109	FP GLAS 781 SW	241	LS 401 TSA WW	67	LS 969 T	154
CD 595 P SW	109	FP GLAS 781 WW	241	LS 401 TSAP	68	LS 969 T LG	154
CD 595 P WW	109	FPI 781 AN	241	LS 401 TSAP LG	68	LS 969 T SW	154
CD 595 PT	109	FUS 4410 BR	235	LS 401 TSAP SW	68	LS 969 T WW	154
CD 595 SW	109	FUS 4410 WW	235	LS 401 TSAP WW	68	LS 990	103
CD 595 WW	109	FUS 4415 WW	235	LS 402 TSA	67	LS 990 GGO	103
CD 90 NA	101	GCR 1940 KO5	93	LS 402 TSA LG	67	LS 990 KO5	104
CO2 A 2178	145	GCR 2178	139	LS 402 TSA SW	67	LS 990 KO5 GGO	104
CO2 A 2178 AL	145	GCR 2178 ORTS	143	LS 402 TSA WW	67	LS 990 KO5 LG	104
CO2 A 2178 BF ANM	145	GCR 2178 TS	141	LS 402 TSAP	68	LS 990 KO5 SW	104
CO2 A 2178 BF SW	145	GCR 2501 TSA	48	LS 402 TSAP LG	68	LS 990 KO5 WW	104
CO2 A 2178 BF WW	145	GCR 2502 TSA	48	LS 402 TSAP SW	68	LS 990 KO5P	104
CO2 A 2178 CH	145	GCR 2503 TSA	48	LS 402 TSAP WW	68	LS 990 KO5P LG	104
CO2 A 2178 MO	145	GCR 2504 TSA	49	LS 403 TSA	67	LS 990 KO5P SW	104
CO2 A 2178 SW	145	GCR 2969 T	154	LS 403 TSA LG	67	LS 990 KO5P WW	104
CO2 A 2178 WW	145	GCR 2990	103	LS 403 TSA SW	67	LS 990 LG	103
CO2 AL 2178	145	GCR 2990 KO5	104	LS 403 TSA WW	67	LS 990 NA	103
CO2 AL 2178 AN	145	GCR 2995	112	LS 404 TSA	68	LS 990 NA LG	103
CO2 AL 2178 D	145	GCR 2995 KO5	113	LS 404 TSA LG	68	LS 990 NA SW	103
CO2 CD 2178	145	GCR 2995 P	112	LS 404 TSA SW	68	LS 990 NA WW	103
CO2 CD 2178 GR	145	GO 1940 KO5	93	LS 404 TSA WW	68	LS 990 P	103
CO2 CD 2178 LG	145	GO 2501 TSA	48	LS 404 TSAP 14	69	LS 990 P LG	103
CO2 CD 2178 SW	145	GO 2502 TSA	48	LS 404 TSAP 23	69	LS 990 P SW	103
CO2 CD 2178 WW	145	GO 2503 TSA	48	LS 404 TSAP LG 14	69	LS 990 P WW	103
CO2 ES 2178	145	GO 2504 TSA	49	LS 404 TSAP LG 23	69	LS 990 SW	103
CO2 GCR 2178	145	GO 2990	103	LS 404 TSAP SW 14	69	LS 990 WW	103
CO2 LS 2178	145	GO 2990 KO5	104	LS 404 TSAP SW 23	69	LS 995	112
CO2 LS 2178 LG	145	GO 2995	112	LS 404 TSAP WW 14	69	LS 995 GGO	112
CO2 LS 2178 SW	145	GO 2995 KO5	113	LS 404 TSAP WW 23	69	LS 995 KO5	113
CO2 LS 2178 WW	145	GO 2995 P	112	LS 409 T	75	LS 995 KO5 LG	113
CO2 ME 2178 AT	145	HS 2 RF	86	LS 4093 TSA	75	LS 995 KO5 SW	113
CO2 ME 2178 C	145	HS 4 RF	86	LS 4093 TSA LG	75	LS 995 KO5 WW	113
DAS 4120	233	IPR 200 REG	156	LS 4093 TSA SW	75	LS 995 KO5MP	113
DAS 4210	234	IPS 200 REG	156	LS 4093 TSA WW	75	LS 995 KO5MP LG	113



# Terms and Conditions of Sale and Supply

## I. General provisions

- 1) The mutual written declarations shall determine the scope of the supplies and services (hereinafter: supplies). However, General Terms and Conditions of Business on the part of the customer shall only apply insofar as we have expressly approved the same in writing.
- 2) We shall unrestrictedly reserve our exploitation rights under proprietary right and copyright law to cost estimates, drawings and other documents (hereinafter: documents). Such documents may only be rendered accessible to third parties with our prior consent and, upon request, shall, in the event that we should not be awarded the commission, be returned to us without delay. Sentences 1 and 2 shall apply mutatis mutandis to the customer's submissions, though such submissions may be rendered accessible to third parties to whom we have admissibly assigned responsibility for supplies.
- 3) Partial supplies shall be admissible insofar as the customer may be reasonably expected to accept the same.

## II. Prices and Terms and Conditions of Payment

- 1) Prices shall be understood to be ex-works excluding packaging and plus the statutory sales tax obtaining at any given time.
- 2) Packaging shall be invoiced at the lowest possible prices and shall not be taken back.
- 3) Insofar as nothing is agreed to the contrary, payment shall, irrespective of the receipt of the goods involved, be made to us net within thirty days of the invoice date or within eight days with a 2 % discount. In the event that the payment deadline should be exceeded interest shall, without a reminder being required, be calculated pursuant to § 288 German Civil Code.
- 4) We shall be entitled to request advance payments in respect of the invoice amounts at any time prior to the dispatch of goods insofar as we deem such a step to be necessary. Should the customer default on the fulfillment of payment obligations or should the information pertaining to a customer no longer be satisfactory, we shall be entitled to request security for delivered goods or, once a payment deadline has been set, withdraw from the purchase contract.
- 5) The customer may only offset receivables which are undisputed or have been established on a legally binding basis.

## III. Reservation of title

Goods shall be supplied subject to reservation of title involving the following extensions:

- 1) All supplied goods shall remain our property until such time as our claims vis-à-vis the customer, including any such claims which may arise from the business link in the future, are settled in full and for such time as the account, including the bill and cheque commitments, has not been settled. This shall also apply in the event that the purchase price for certain deliveries of goods specified by the customer is to be paid. In the case of a current account, the reserved title shall constitute security for our balance claim.
- 2) The customer shall be revocable and, as long as they fulfill their obligations vis-à-vis ourselves and affording consideration to the following provisions, entitled to sell and process during the normal course of business goods which are encumbered with reservation of title. However, the customer shall be forbidden from pledging or assigning as security goods subject to reservation of title which are supplied or processed. The customer shall, insofar as this is compatible with commercial practices, likewise undertake only to resell reserved goods which we have supplied in conjunction with reservation of title. Upon justified request and in the case of default, the customer shall be obliged to apprise us of the name of the third party customer.
- 3) Insofar as goods encumbered with reservation of title are processed, such processing shall, though without any guarantee on our part, be effected for us. In the event of processing by the customer in conjunction with goods which are not our property, we shall be entitled to co-ownership of the new object at the ratio of the value of the reserved goods to the other processed goods on the processing date.
- 4) In the event that goods which we have supplied should be combined with other goods, we shall acquire co-ownership of the amount of the ratio of the value of the reserved goods in the combination date.
- 5) Should the customer sell reserved goods which we have supplied or should such goods be supplied to a third party – irrespective of what value or in which condition – or should such goods be installed within the framework of a work, work performance or a construction contract, the customer shall, until such time as the claims stipulated in subsection 1) are settled in full, hereby assign to us, to the amount of the invoice value of our deliveries, the claim, together with all ancillary rights, including the compensation claims accruing to them from the legal transaction involving the resale or installation, according to them vis-à-vis their customer or buyer from such sale, delivery or instalment. In the event of an assignment being obtained in such work, work performance or construction contract and in the event of payment default, the customer shall undertake to apprise their third party customers of the advance assignment.
- 6) In the event that reserved goods which we have supplied should be sold to third parties in conjunction with other goods, we shall be assigned that proportion of the total asking price corresponding to the invoice value of our deliveries.
- 7) The reservation of title with the extensions pursuant to the above provision shall also remain in force in the event of individual claims against their customer on the part of the customer being included in the current account. In this case, the customer shall, at this early juncture, assign to us the balance obtaining to their credit. The customer shall, upon request and particularly in the event of payment default on the part of the purchaser, be obliged to facilitate the direct assertion of the claims involved and apprise the third party debtor of the assignment.
- 8) We shall be appraised without delay of any attachment and every kind of restriction which obtain in respect of our property. In the event that the value of the overall collateral stemming from the business link with which we have been furnished should exceed our delivery claims by more than 20 %, we shall, at the request of the purchaser, be obliged to reassign the assigned claims to such extent.
- 9) In the event of any incidence of damage or other impairment to the equipment supplied on the basis of our terms and conditions, the purchaser shall, at this early juncture, assign to us in advance the compensation claim accruing to them vis-à-vis the insurer from their insurance to the amount of the incidence of damage in question to our reserved property.

## IV. Deadline for deliveries; default

- 1) The deadline for deliveries or services shall commence on the day on which written agreement pertaining to the order in question obtains between the customer and ourselves. The observance of such deadline shall presuppose the prompt receipt of all the documents, requisite licences and releases to be furnished by the customer, the prompt clarification and approval of the plans and the observance of the agreed Terms of Conditions of Payment and other obligations. Should these prerequisites not be fulfilled on time, the delivery deadline shall be extended by an adequate period of time; this shall not apply in the event that we should be responsible for a delay.
  - 2) Should the non-observance of deadlines be attributable to force majeure, such as mobilization, war civil commotion or similar occurrences, e.g. strike or lockout, delivery deadlines shall be extended by adequate periods of time.
  - 3) In the event that dispatch or delivery should, at the behest of the customer, be delayed by more than one month following notification of dispatch readiness, the customer may, for every started month, be invoiced storage costs to the amount of 0.5 % of the price of the delivery objects, though no more than a total of 5 %.
- The contracting parties shall be at liberty to prove that lower or higher storage costs have accrued.

## V. Transfer of risk

The risk shall also pass to the customer in the event that carriagepaid delivery should have been agreed. In the absence of a written arrangement to the contrary, dispatch shall always be effected according to our best judgement. We shall not assume any responsibility for transportation at market prices. We shall only arrange transport insurance policies the costs of which are borne by the purchaser upon express, written agreement.

## VI. Acceptance

The customer may not refuse to accept deliveries on the grounds of the existence of minor defects.

## VII. Material defects

- 1) The prerequisite for the assertion of material defects liability shall be the submission to us or our authorized representative of proof of acquisition (delivery note, invoice, etc.). The warranty entitlement may not be transferred to third parties without our consent.
- 2) All those components or services shall, as we see fit, be repaired, resupplied or refurbished which feature a material defect within the limitation period – irrespective of operating life – insofar as the origin of the same obtained at the point in time of transfer of risk.
- 3) Material defects claims shall lapse after twelve month. This shall not apply insofar as the law pursuant to §§ 438, paragraph 1, no. 2 (constructions and objects for constructions), 479, paragraph 1 (claim under a right of recourse) and 634a, paragraph 1, no. 2 (construction defects) German Civil Code makes provision for longer periods of time, in instances of injury to life, body or health, in the event of a willful or grossly negligent breach of duty on our part and in the event of the malicious nondisclosure of a defect. The statutory provisions pertaining to the suspension of the running of a period, suspension and recommencement of periods shall remain unaffected.
- 4) The customer shall submit complaints pertaining to material defects to us in writing without delay.
- 5) In the event of notifications of defects, payment on the part of the customer may be withheld on a scale which is in a reasonable ratio to the material defects which have occurred. The customer may only withhold payments should a complaint be asserted the justification of which is beyond doubt. Should a complaint have been submitted without justification, we shall be entitled to request that the customer reimburse the costs which we incurred.
- 6) In the first instance, we shall be granted the opportunity to effect subsequent fulfillment within a reasonable period of time.
- 7) Should such subsequent fulfillment be unsuccessful, the customer – any compensation claims pursuant to subsection IX notwithstanding – may withdraw from the contract or reduce the amount of payment.
- 8) Claims arising from defects shall not obtain in respect of a minor deviation from an agreed quality, a minor impairment to usefulness, natural wear and tear or incidences of prejudice which arise subsequent to the risk transfer in consequence of faulty or negligent handling, excessive strain, unsuitable operating facilities, faulty construction operations, unsuitable subsoil and, in particular, any external influences which are not presupposed by the contract, as well as in respect of non-reproducible software defects. In the event that modifications or maintenance operations should be improperly performed by the customer or any third parties, it shall likewise be the case that no claims arising from defects shall obtain for such modifications and maintenance operations or any resulting consequences.
- 9) Any claims on the part of the customer for expenditure which it is necessary to incur for subsequent fulfillment purposes, particularly transport, travelling, labour and material costs, shall be excluded insofar as such expenditure increases due to the fact that a delivery object has been subsequently transported to a location other than the customer's business premises unless such transportation is in line with the normal utilization of such object.
- 10) Claims under rights of recourse vis-à-vis ourselves on the part of the customer pursuant to § 478 German Civil Code (contractor's recourse) shall only obtain insofar as the customer has not agreed any arrangements with their customer exceeding the scope of the statutory claims arising from defects. No. 9 shall additionally apply mutatis mutandis to the scope of the customer's claim under a right of recourse vis-à-vis ourselves pursuant to § 478, paragraph 1 German Civil Code.
- 11) It should be noted that subsection IX (other compensation claims) shall apply to compensation claims. Any more farreaching claims for a material defect against us and our vicarious agents on the part of the customer and any claims for a material defect against us and our vicarious agents on the part of the customer other than those stipulated in subsection VII shall be excluded.

## VIII. Impossibility, contractual revision

- 1) Insofar as a delivery is impossible the customer shall be entitled to claim compensation unless we are not responsible for such impossibility. However, the customer's entitlement to compensation shall be restricted to 10 % of the value of that component of the delivery which cannot be put into appropriate operation in consequence of such impossibility. This entitlement shall not apply insofar as, in cases of wilful intent, gross negligence or injury to life, body or health, compulsory liability obtains; this shall not entail a change in the burden of proof to the detriment of the customer. The right of the customer to withdraw from the contract shall remain unaffected.
- 2) Insofar as any unforeseeable occurrences within the purport of subsection IV, no. 2 considerably alter the economic importance or the object of a delivery or exercise a major influence on our operations, the contract shall be suitably revised in compliance with the principle of good faith. Insofar as this is not economically justifiable, we shall be entitled to withdraw from the contract. In the event that we should wish to exercise this right of withdrawal, we shall apprise the customer accordingly without delay upon becoming cognizant of the implications of the occurrence in question, including in the event that an extension of the delivery period should initially have been agreed with the customer.

## IX. Other compensation claims

- 1) Claims for compensation and claims for the compensation of expenses (hereinafter: compensation claims), irrespective of on which legal grounds, particularly for a breach of the duties arising from the contractual obligation and for tortious acts, shall be excluded.
- 2) This shall not apply insofar as compulsory liability obtains, e.g. pursuant to the Product Liability Act, in cases of wilful intent, gross negligence, injury to life, body or health and a breach of major contractual obligations. However, a claim to compensation for a breach of major contractual obligations shall be restricted to the contractually typical, foreseeable prejudice insofar as wilful intent or gross negligence do not obtain or liability obtains due to injury to life, body or health. The above stipulations shall not entail a change in the burden of proof to the detriment of the customer.
- 3) Insofar as the customer is entitled to compensation claims pursuant to subsection IX, such claims shall lapse upon the expiry of the limitation period pursuant to subsection VII, no. 3 applying to claims for material defects. In the case of compensation claims pursuant to the Product Liability Act, the prevailing statutory limitation provisions shall apply.

## X. Diagrams, measurements and weights

Diagrams, measurements and weights shall always be regarded as approximate.

## XI. Place of performance, place of jurisdiction and applicable law

- 1) Insofar as nothing to the contrary is agreed, the place of performance shall be Schalksmühle.
- 2) In the event of the customer being a businessman, the sole place of jurisdiction for all disputes arising directly or indirectly from the contractual relationship shall be Hagen. However, we shall also be entitled to institute legal proceedings at the place of domicile of the customer.
- 3) German substantive law shall, to the exclusion of the UN Convention on Contracts pertaining to the International Sale of Goods (CISG), apply to the legal relations obtaining in connection with this contract.

XII. The remaining provision of the contract shall continue to have binding force even in the event of the legal invalidity of any of the individual provisions contained in the same. This shall not apply in the event of adherence to the contract constituting unreasonable hardship for one of the contracting parties.

## Further information

Good to know: Brochures, films, websites and web portals – further information, tools and practical supplements for the smart JUNG technology can be found here.

### JUNG BROCHURES



#### **KNX – THE SECURE AND SAFE STANDARD**

Worldwide standard: the KNX system with benefits, application examples and references from commercial building and private home construction. Including checklist for the „Security“ subject.



#### **KNX SMART HOME**

The intelligent home – professionally realised using solutions from JUNG. With advantages and application examples; ideal for the customer discussion.



#### **eNet SMART HOME**

Smart wireless technology, intelligently retro-fitted. Systematics, modules, advantages and strong partners. With practical application examples.

## WEBSITES AND ONLINE PORTALS



### JUNG WEBSITE

All information about the KNX solutions can be found thematically prepared and illustrated on the JUNG website. Naturally also with further links and download material.

**[jung-group.com](http://jung-group.com)**

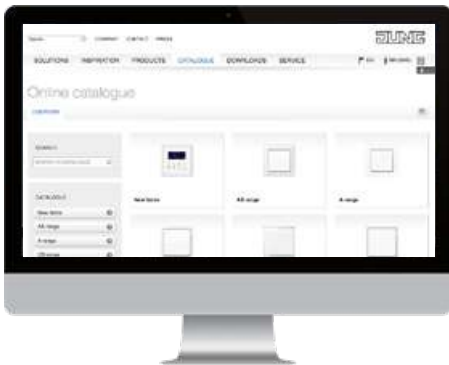

### JUNG ONLINE CATALOGUE

Technical information for viewing and for download is attached to the individual JUNG articles in the online catalogue.

**[jung-group.com/online-catalogue](http://jung-group.com/online-catalogue)**



### KNX FILMS

Descriptive films for possibilities and handling of various KNX solutions can be found in the JUNG media database.

**[jung-group.com/movies](http://jung-group.com/movies)**



### FEELSMART.

The web platform for Smart Home solutions: Electrical installers, planners and owners come together here to plan projects jointly via On-line Configurator.

**[feelsmart.com](http://feelsmart.com)**



**ALBRECHT JUNG GMBH & CO. KG**

P.O. Box 1320

58569 Schalksmühle

Germany

Phone +49 2355 806-553

Fax +49 2355 806-254

[international@jung.de](mailto:international@jung.de)

For sales contacts in your country see:

[jung-group.com/contact](http://jung-group.com/contact)

**JUNG-GROUP.COM**